An abstract watercolor painting of a hot air balloon. The balloon's envelope is filled with swirling patterns of light blue, orange, and red, suggesting a colorful sky or a specific atmosphere. The balloon is tethered to a dark, rectangular basket at the bottom. The background is a soft, light blue wash with some darker blue and red accents, creating a dreamlike and artistic representation of the subject.

# A Vision for Environmentally Conscious Plutonium Processing

*Larry R. Avens and P. Gary Eller*



**R**egardless of popular or political opinions about the uses of plutonium, plutonium processing will continue globally for many decades. In the United States, plutonium plays a central role in national defense: it is routinely formed into samples for experiments, cast or machined into nuclear weapon pits, and extracted from retired nuclear weapons or weapon components and prepared for disposal. All these activities require that plutonium be chemically or mechanically processed.

An unavoidable consequence of plutonium processing is that it generates radioactively contaminated gas, liquid, and solid waste streams. Although these streams are currently handled in a manner that fully complies with today's laws, future laws will likely impose more-stringent requirements. Tellingly, President Clinton signed on Earth Day 2000 an executive order that directs federal facilities to reduce releases of

toxic compounds by 40 percent and to develop or update pollution prevention plans. Similar "green" regulations that deal explicitly with radioactive waste are not far behind.

Recent advances in actinide science and technology, however, now make it possible to drastically reduce, or even eliminate, the problematic waste streams from plutonium processing operations. Waste minimization will not only keep actinides out of the environment but also limit the amount of retrievable fissile material that must be shipped to a nuclear-waste repository (thus reducing proliferation risks). Waste minimization will also reduce the cost of current plutonium operations and ensure the viability of future ones. But most important, minimization is the morally correct waste-management action. With it, the nation can avoid saddling future generations with costly environmental and economic legacies from plutonium processing.

This article discusses the processing operations conducted at the Los Alamos Plutonium Facility and describes a number of advanced technologies that could radically reduce the operations' radioactive waste streams. Incorporating such technologies into an integrated waste-management program at Los Alamos promises to provide a "90 percent solution" to the facility's waste problem: it could reduce solid waste volume and liquid waste radioactivity by 90 percent. This program could be implemented within five years at Los Alamos and could also be implemented at other DOE sites that conduct plutonium operations. In addition, the advanced technologies could be used to treat and dispose of legacy wastes at DOE sites that must now be cleaned up, such as the Hanford Site in Washington and the Rocky Flats Environmental Technology Site in Colorado. Several of these technologies are elaborated upon in boxes that follow this article.

## Plutonium Processes at TA-55

Virtually all plutonium operations at Los Alamos occur within the Plutonium Facility at Technical Area 55. It is the nation's most modern plutonium facility, consisting of a 75,000-square-foot building that is built to withstand 200-mile-per-hour tornadic winds and any credible seismic event. The facility has a back-up generator to power critical systems in case of power outages. TA-55, as the facility is commonly called, opened in 1978.

The work at TA-55 supports a wide range of national programs, such as stockpile stewardship, nuclear materials stabilization, materials disposition, and nuclear energy. Each of these programs, which are discussed briefly in the box that begins on this page, revolves around plutonium. In stockpile stewardship, for example, pure plutonium metal is used to manufacture nuclear-weapon pits or to conduct experiments related to maintenance of the nation's nuclear stockpile. The materials disposition program recovers plutonium from decommissioned weapons and processes it for eventual disposal or for burning as mixed oxide (MOX) fuel.

Almost all the plutonium at TA-55 has been recycled, having been recovered from previous TA-55 operations or from operations at other sites. But plutonium continually undergoes radioactive decay, and trace amounts of uranium, neptunium, and americium impurities accumulate in aged metal. These impurities must be removed before the material can be reused. In addition, the plutonium used for an experiment may have been alloyed, become oxidized, or been formed into a chemical compound; it too must be purified before reuse.

Thus a significant portion of the work done at TA-55 involves chemical processing to produce pure plutonium metal. Nitric acid anion exchange, or nitric acid processing, and pyrochemical processing are the two production-scale techniques that are used

## Major Programs at TA-55

**Stockpile Stewardship.** The primary mission at TA-55 is to service the United States' nuclear stockpile. The largest task in the 21st century will be to fabricate nuclear



weapon pits for the stockpile. (The pit is a weapon's core and contains the plutonium.) We have already prepared a few pits for testing, and many operations at TA-55 are being upgraded and modified to build pits on a routine basis. In addition, under the Office of Defense Programs sponsorship, TA-55 performs surveillance activities on pits; they are dissected on a

prescribed schedule to ensure that all materials and parts will perform as intended. If a problem is identified, a remedy is developed and implemented. Furthermore, TA-55 also prepares alloys and other actinide-containing materials for many defense-related experiments. These experiments require plutonium samples that meet demanding chemical and physical specifications.



**An induction furnace melts plutonium, which is then cast into pits.**



**A plutonium rod is being machined on a lathe.**



**The pressurized inert-gas metal arc welder is used for welding pits.**

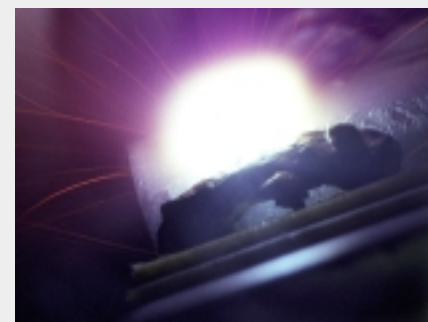

**A laser ablates the surface of a plutonium sample. The vapor is spectroscopically analyzed to determine the chemical purity of the plutonium.**

**Materials Disposition.** In 1993, President Clinton mandated the removal of 50 tonnes of plutonium from the defense stockpile. The plutonium, some of which is in storage, comes from retired nuclear weapons and weapon-production processing streams and is never to be used again in weapons. To support this mandate, the DOE formed the Office of Fissile Materials Disposition, whose mission is to define the path and final disposition of this excess plutonium.

As part of the disposition program, Los Alamos has developed the Advanced Recovery and Integrated Extraction System (ARIES), which will extract plutonium from pits and convert it to either a metal puck or plutonium oxide powder. In either form, the plutonium can be internationally monitored because the pits' original, classified shapes or sizes cannot be discerned. (The mass of the final product is also altered.) An outstanding attribute of ARIES is the minimal waste that is generated. Neither liquids nor solid chemicals are involved in any processing steps. A full-scale pit disassembly and conversion facility using ARIES technology is planned for construction and operation at the Savannah River Site within 10 years.

Ultimately, the excess plutonium will be either incorporated into MOX fuel for use in nuclear power reactors or immobilized in glass (vitrified) and stored in a high-level-waste repository. TA-55 prepared the first MOX fuel made from weapons plutonium. That fuel will be "burned" in Canada's Chalk River Reactor, along with equivalent fuel made from Russian weapons. Facilities to produce MOX fuel and glass waste are also planned for the Savannah River Site.

**Nuclear Energy.** TA-55 is also where the nation's plutonium-238 heat sources are fabricated. A 150-gram pellet of plutonium-238 dioxide has a thermal output of approximately 62 watts, and radioisotope thermoelectric generators can convert that heat energy to electrical energy. The United States has used radioisotope power and heater units in its space program for nearly 40 years, beginning with the Transit navigational satellites that were launched in 1961. Since then, plutonium-238 has provided power or heat for meteorological satellites, the Apollo Lunar Surface Experiment Packages (ALSEP), the Viking Mars lander, the Galileo deep-space probe to Jupiter, the Ulysses solar pole mission, and the Mars Pathfinder. A recent use of plutonium-238 in space is to power the Cassini probe, which was launched late in 1997 and is now on its way to Saturn. Components for these power sources undergo extensive safety testing to ensure their safe and reliable use in space.

Los Alamos is developing an aqueous recovery process to purify plutonium-238 from old heat sources and scrap oxide that are currently stored in the DOE complex. In addition, we are developing a molten-salt oxidation process to recover plutonium-238 from combustible process residues. Implementation of these technologies will reduce waste volume and enable us to recycle plutonium-238 for use in future space missions.

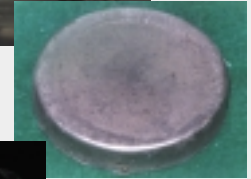

(Clockwise from upper left): The hydride/dehydride module in ARIES; the glove-box train for moving material between ARIES process steps; a plutonium metal puck; a decontaminated package for storing the plutonium.

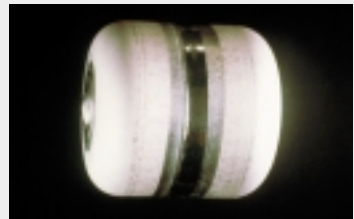
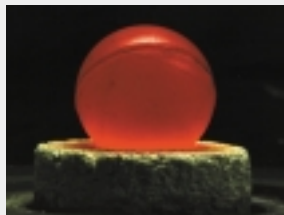

(Clockwise from upper left): A 250-gram sphere of  $^{238}\text{Pu}$  oxide with a thermal output of 100 watts; a general-purpose heat source that holds about 110 grams of  $^{238}\text{Pu}$  and is used to fuel a radioisotope thermoelectric generator;  $^{238}\text{Pu}$  supplies energy for the Cassini satellite.

**Nuclear Materials Stabilization.** A significant amount of America's excess defense plutonium is contained in chemical processing residues, metals, and oxides that were left when DOE ended weapons production in 1989. Much of this material is in a form that is inappropriate for storage or ultimate disposition. More than 65,000 items at 13 DOE sites—containing some 26 tonnes of plutonium—have been identified as posing potential hazards to workers and the environment.



In 1994, the Defense Nuclear Facilities Safety Board delivered Recommendation 94-1 to the Secretary of Energy, recommending that DOE establish a program to resolve this problem. The DOE response included establishing a research program to develop methods to safely stabilize and store plutonium metal, oxides, solutions, and residues from the Rocky Flats, Hanford, and Savannah River sites and from the Los Alamos and Livermore laboratories. A major program goal has been to minimize the creation of any further wastes.



The research program has been managed by the Laboratory's Nuclear Materials Technology Division on behalf of the DOE complex. Much of the required stabilization is now either completed or the required technologies are close to being implemented. The current objective is to ensure safe storage of the stabilized materials at Savannah River for up to 50 years, pending their ultimate disposition. Recent research demonstrated that up to four times as much material as was previously allowed can now be stored safely for 50 years.



**Legacy wastes (from the top):** scrap plutonium metal, a corroded plutonium-contaminated can, pieces of a magnesium oxide crucible once used for plutonium processing, and impure plutonium oxide powder inside a ceramic pestle.



Transuranic waste in interim storage at the Idaho National Environmental Engineering Laboratory. These barrels are to be shipped to WIPP.



Barrels often contain a potpourri of ordinary items, such as gloves, jars, rags, and tape, that are contaminated with plutonium and other actinides.

extensively. Nitric acid processing produces purified plutonium dioxide, which is then further processed by pyrochemical operations to produce very pure plutonium metal.

Nitric acid processing is the workhorse at TA-55, having been used over the last 20 years to process literally tons of plutonium. Pyrochemical processing was used extensively at Rocky Flats and is still used to purify plutonium at TA-55. While both processes are efficient and robust, they produce a prodigious stream of low-level and transuranic (TRU) waste.<sup>1</sup> There are various repositories around the country for low-level waste, including one at Los Alamos. The Waste Isolation Pilot Project (WIPP) in New Mexico is the nation's repository for defense-related TRU waste.

Several recent R&D successes at Los Alamos, however, have dramatically reduced the waste volume that results from these processes.

**Nitric Acid Processing.** Nitric acid is used both as a dissolution agent and a processing medium. Impure scrap plutonium or plutonium-contaminated items, such as glass, graphite casting molds, magnesium oxide crucibles, and incinerator ash, can be dissolved in or leached with nitric acid, while impure plutonium oxide can be dissolved in the acid. (Dissolving plutonium metal in nitric acid produces an unstable residue that is pyrophoric and susceptible to shock-induced explosions. Thus for processing, if the plutonium is not already an oxide, it is converted to one by burning the metal.)

During processing, the plutonium-containing nitric acid solution is passed

<sup>1</sup>Low-level waste has less than 100 nanocuries of radioactive material per gram of waste material (nCi/g). TRU waste is contaminated with transuranic elements (elements whose atomic numbers are greater than that of uranium) at more than 100 nCi/g. (For <sup>239</sup>Pu, this is equivalent to 1.6 µg/g.) TRU waste comes primarily from defense- and space-related programs. Other waste categories include remotely handled TRU waste, mixed wastes, and high-level waste. TA-55 produces only low-level, TRU, and mixed wastes.

through a column packed with thousands of beads made from anion-exchange resin (Figure 1). The resin is an organic polymer that contains cationic (positively charged) sites. Anionic (negatively charged) complexes in solution bind these cationic sites and hence sorb to the resin. As it turns out, plutonium is one of only a handful of elements that can form stable anionic complexes in nitric acid; it forms plutonium hexanitrate  $\text{Pu}(\text{NO}_3)_6^{2-}$ . This Pu(IV) complex has the highest sorption coefficient of any metal ion to certain resins, particularly at nitric acid concentrations of about 7 molar (M). Plutonium is preferentially sorbed, while most other elements simply flow through the column and are flushed from the system.

Once the resin has been “loaded,” the plutonium is recovered by sending an eluting solution (0.5 M nitric acid plus a small amount of hydroxylamine nitrate) through the column. The Pu(IV) has little affinity for the resin in the dilute nitric acid, so it desorbs and flows with the solution into holding tanks.

Pure plutonium dioxide is recovered after precipitation and calcination steps. As with all plutonium processes, anion exchange produces contaminated waste. The resin does not remove all the plutonium from solution, and thus the nitric acid solutions always contain low levels of plutonium after they have passed through the anion-exchange process. The contaminated effluents from the column and the holding tanks are therefore sent to an evaporator. The evaporator bottoms, which contain most of the residual plutonium, other actinides, and impurity elements are stabilized in cement and disposed of as TRU waste.

The condensed vapor from the evaporator, however, is *still* radioactive, with an activity of about  $6 \times 10^{-5}$  curies per liter (Ci/L). This distilled liquid is piped to holding tanks at TA-50, where it is treated with a flocculating agent to precipitate all remaining actinides. With a miniscule activity of less than  $3 \times 10^{-11}$  Ci/L, the effluent is discharged to the environment.

Figure 1. Nitric Acid Processing System

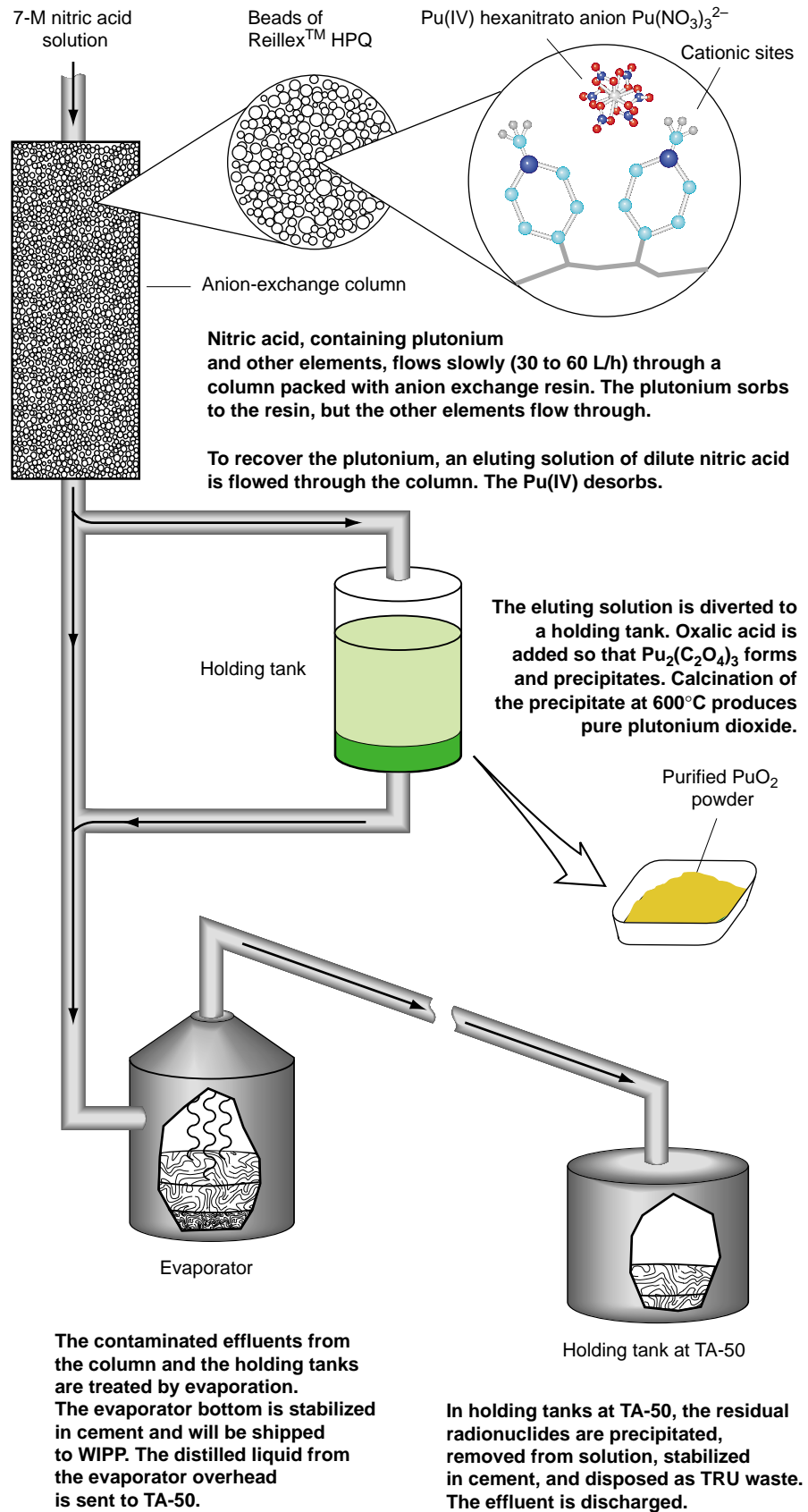

For decades, Los Alamos has sought ways to improve the nitric acid process and reduce the hazardous components in the waste stream. For example, because some plutonium always remains sorbed to the anion-exchange resin, ultimately the resin must also be disposed of as TRU waste. In the late 1980s, Los Alamos collaborated with Reilly Industries, Inc., to develop Reillex™ HPQ resin. Compared with earlier resins, HPQ has an improved sorption for plutonium. It is less prone to radiolytic or chemical degradation in the harsh, radioactive nitric acid environment. Its enhanced stability allows the resin to be used for hundreds of plutonium recovery cycles before being replaced.

During the early 1990s, we began to use advanced spectroscopic techniques to obtain a molecular-level understanding of plutonium in nitric acid solutions. That research and a fruitful collaboration with Texas Tech University have led to the development of bifunctional exchange resins that promise to further improve the plutonium anion-exchange process. This R&D story is told by Marsh et al. on page 454.

We can do more, however, to treat the liquid-waste stream that is generated by the nitric acid process. The discharged effluent from TA-50, for example, is relatively high in nitrates. In general, these act as fertilizers in the environment and may adversely influence the local ecology. Equally disturbing is the fact that high nitrate concentrations in drinking water can lead to a health condition, methoglobinemia, in some infants younger than six months. The nitrates will be removed from the discharged liquid by a recycle evaporator, as discussed in a later section.

### Pyrochemical Salt Processing.

Pyrochemical processes involving molten calcium, potassium, and sodium chlorides are used at TA-55 to prepare and purify plutonium metal. Two advantages of these methods are the compactness of their equipment and their rapid reaction kinetics.

The plutonium dioxide from nitric acid processing is converted to plutonium metal in a pyrochemical process called direct oxide reduction (DOR). As shown in Figure 2(a), plutonium dioxide and calcium metal are reacted in molten calcium chloride within a magnesium oxide crucible. The plutonium dioxide is reduced to plutonium metal, while the calcium oxide byproduct remains dissolved in the calcium chloride. The calcium oxide is then converted back to calcium chloride *in situ* by bubbling chlorine gas through the molten salt. Once the salt is regenerated, more plutonium dioxide and calcium metal can be added to the crucible to produce more plutonium metal. The DOR process can be run several times before the plutonium metal is recovered and the salt and crucible discarded as TRU waste.

The plutonium metal recovered from DOR is not very pure, however, because calcium chloride always contains trace amounts of impurities that are readily absorbed by the plutonium. The metal can be made very pure by electrorefining, which is described in Figure 2(b). Unfortunately, this pyrochemical process has a low product yield. Only about 80 percent of the original plutonium metal is purified. The remaining 20 percent—containing nearly all of the impurities—is fed back into the nitric acid and pyrochemical processing streams.

A third pyrochemical process, molten salt extraction (MSE), removes americium from aged plutonium metal. No plutonium sample is isotopically pure, but always contains a mix of isotopes, including plutonium-241. This isotope has a half-life of 13.2 years and decays by beta decay to americium-241. For many years, MSE was used at Rocky Flats to extract this ingrown americium. The aged plutonium metal was purified using liquefied sodium chloride/potassium chloride in a magnesium oxide crucible. The waste stream consisted primarily of the crucible and voluminous salt residue.

At TA-55, we have made several

improvements to the MSE process that substantially reduce this waste stream. In our process, shown in Figure 2(c), the plutonium is reacted with chlorine gas at high temperature in a reusable tantalum crucible. This produces plutonium chloride, PuCl<sub>3</sub>, *in situ*, which then reacts with the americium in the metal to produce americium chloride, AmCl<sub>3</sub>. The AmCl<sub>3</sub> and some PuCl<sub>3</sub> form an easily removed salt crust on top of the purified plutonium metal.

The salt mixtures that are used in DOR and electrorefining, and that were used in the old MSE operations, become contaminated with residual plutonium and other actinides. Recovering this plutonium by nitric acid processing was problematic; the large concentration of chloride ions would combine with nitrate ions to form aqua regia, which is a volatile, highly corrosive liquid. Thus in the past, these residues were discarded as TRU waste if the plutonium content was low enough.

At TA-55, even this plutonium is recovered and removed from the waste stream. Instead of nitric acid, the salt or crucible residues are dissolved in hydrochloric acid (HCl). The plutonium is purified by solvent extraction, and the purified plutonium converted to plutonium dioxide powder through oxalate precipitation and calcination, similar to what is done during nitric acid processing. To treat the HCl waste solution, the effluent is made caustic, that is, it is made basic with a pH of 10 or higher. Under these conditions, the actinides precipitate and can be removed by simple filtration. At this point, the caustic liquid waste has an activity of about 10<sup>-3</sup> Ci/L and is sent to TA-50 for further treatment. However, an extraction chromatography process is being developed to replace the caustic precipitation/filtration processes.

As a result of recent R&D work, the technology is now available to vacuum distill sodium and potassium chloride salts at elevated temperature. Distillation directly separates the plutonium residue from the bulk salt without the use of an aqueous process. (Given its

(a) Direct Oxide Reduction (DOR)

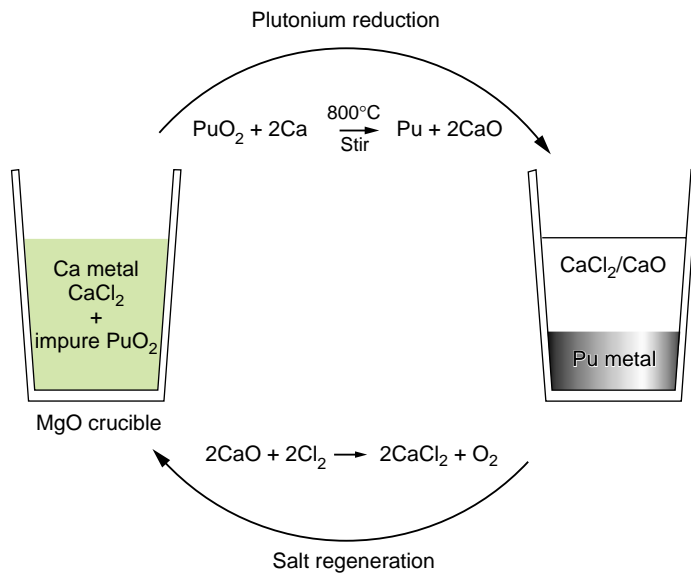

**Figure 2. Current Pyrochemical Salt Processes**

(a) DOR reduces plutonium dioxide (often obtained from nitric acid processing) to plutonium metal. The plutonium dioxide is combined with calcium metal and calcium chloride, and the mixture is liquefied. The plutonium dioxide is reduced to plutonium metal, producing calcium oxide. The calcium oxide is then converted back to calcium chloride by bubbling chlorine gas through the liquefied salt product. This conversion step allows us to reuse the salt and the crucible. More plutonium dioxide and calcium metal are added to the crucible, and the process can be run several times before the plutonium metal is recovered and the salt and crucible are discarded.

(b) Electrorefining (ER)

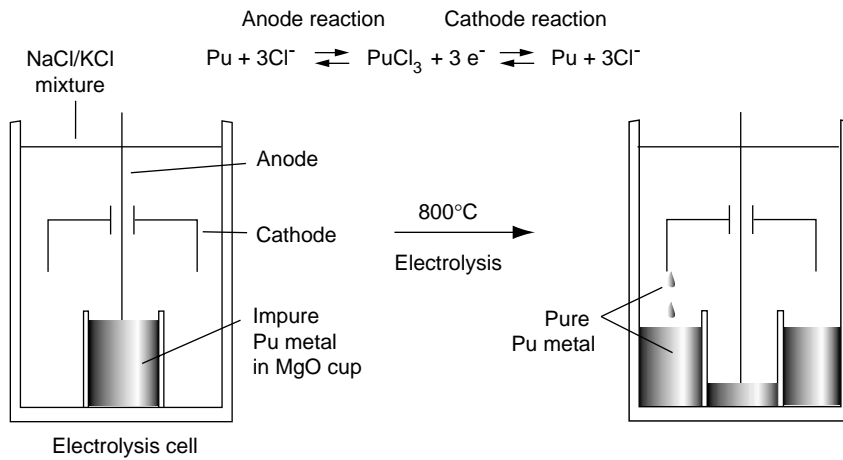

(b) Metal from DOR is purified by electrorefining. The impure plutonium metal is placed in a MgO cup inside an electrolysis cell, which is filled with a NaCl/KCl salt mixture. The cell is heated to 800°C to melt the contents and to begin electrolysis. The plutonium metal is oxidized to plutonium chloride, PuCl<sub>3</sub>, which dissolves in the molten salt. The PuCl<sub>3</sub> migrates to the cathode, where it is reduced to pure plutonium metal. This drips from the cathode and collects in the annular region outside the cup. A ring of pure plutonium is produced within a few days. About 20% of the original plutonium stays in the cup and contains essentially all of the initial impurities.

(c) Molten Salt Extraction (MSE)

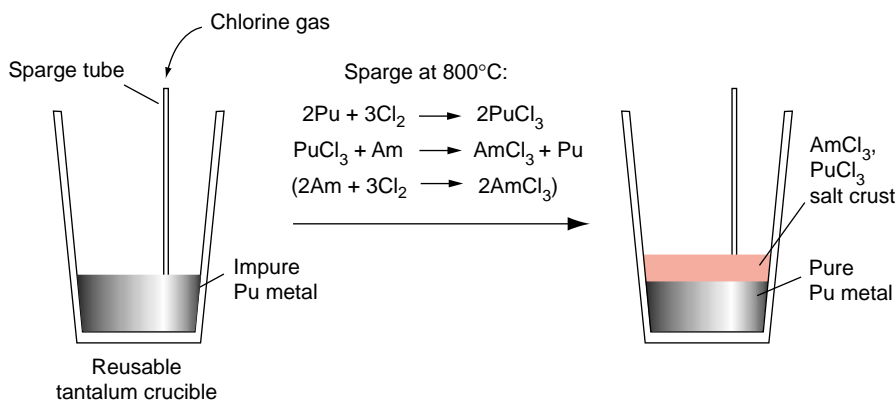

(c) MSE is used to remove americium from aged plutonium. The plutonium metal is liquefied in a reusable tantalum crucible and then chlorine gas is bubbled (sparged) through the liquid. Plutonium chloride forms, which is reduced to plutonium metal as the americium oxidizes to americium chloride. (The americium is also oxidized directly to americium chloride, but at a much slower rate than the corresponding plutonium reaction.) Upon cooling, americium chloride and some plutonium chloride form a thin crust on top of the plutonium metal.



**Table I. Approximate Annual Solid Waste at TA-55**

Category	Volume (m <sup>3</sup> )	Mass (kg)	55-Gallon Drums
TRU Waste			
Combustible	22	2600	100
Metal	31	14600	84
Cement	13	18000	65
Filters, glass, graphite	5	1000	24
Leaded gloves	3	2500	13
Low-level Waste	200 to 500		

**Table II. Approximate Annual Liquid Waste at TA-55**

Category	Volume (L)	Activity Limit (Ci/L)	Total Activity (Ci)
Caustic	10,000	$4.5 \times 10^{-3}$	< 45
Acid	50,000	$6 \times 10^{-5}$	< 3
Industrial	730,000	$5 \times 10^{-7}$	< 0.4

low volatility, the calcium chloride used to reduce plutonium in DOR is not amenable to distillation.) As described in the box on “Salt Distillation” on page 449, salt distillate with contamination levels below low-level-waste thresholds has been achieved in small-scale tests. When this process is deployed for full-scale use at TA-55, the salt will be either discarded as low-level waste (at a fraction of its current disposal cost as TRU waste) or will be recycled into pyrochemical operations.

### Waste Generation at TA-55

Nitric acid and pyrochemical processing produce radioactive waste in the form of contaminated reagents and processing equipment. But routine execution of the programs discussed on pages 438–440 also produces low-level and TRU waste because nearly everything associated with manipulating plutonium becomes contaminated. The air that passes through the stainless

steel glove boxes, for example, must be filtered through high-efficiency particulate air (HEPA) filters, which then become contaminated with plutonium. Any tools used within a glove box become contaminated, as do the glove boxes themselves and their lead-lined gloves. The towels used to wipe down equipment, the plastic containers used to hold parts or tools, the bottles, tubing, and tape—all become contaminated through use.

Table I lists the approximate annual quantities of solid waste generated at TA-55 during the 1990s. Over this period, nearly 40,000 kilograms of solid TRU waste was generated each year. Metal items and cement (which stabilizes evaporator bottoms) account for all but a fraction of the waste mass, and in terms of volume, represent about 60 percent of the waste. Combustibles, such as plastics, rags, rubber, and organic liquids, account for nearly 30 percent of the volume. The solid TRU and low-level wastes are stored at Los Alamos’ TA-54. The low-level wastes

are buried on-site, while the TRU wastes are stored until they can be shipped to WIPP in southern New Mexico.

Table II lists the approximate annual output of liquid waste. While the volume is dominated by industrial liquid waste, the total amount of radioactive material in this category is substantially less than a curie. Rather, the small volume of caustic liquid waste from hydrochloric processing contains about 90 percent of the radionuclides in the liquid-waste stream.

### The 90 Percent Solution: Integrated Waste Management

We have already developed or are currently investigating new technologies, such as hydrothermal processing, enhanced pyrolysis, and electrochemical decontamination, that can drastically reduce our combustible and metallic waste volumes. These technologies are robust, can treat a variety of waste matrices, and produce minimal secondary wastes. In most cases, the equipment used by these technologies is compact enough to fit into existing glove-box systems or facilities without major modifications. We are looking to Polymer Filtration<sup>TM</sup> and nitric acid recycle to clean up our radioactive liquid-waste streams.

By integrating these new technologies into a comprehensive waste-management program, we expect to achieve three near-term goals. The first is to decontaminate more than 90 percent of all metallic TRU waste to low-level waste by 2002. Second, we want to reduce the radionuclide content of all liquid effluent produced at TA-55 to the industrial waste limit by 2003. This would reduce by nearly 90 percent the activity of the liquid waste leaving the facility. Third, by 2004, we want to reduce the volume of combustible and noncombustible waste by more than 90 percent. In addition, we plan to vitrify, or encase in glass, the TRU-waste evaporator bottoms rather than stabilize them in cement. Because the glass can

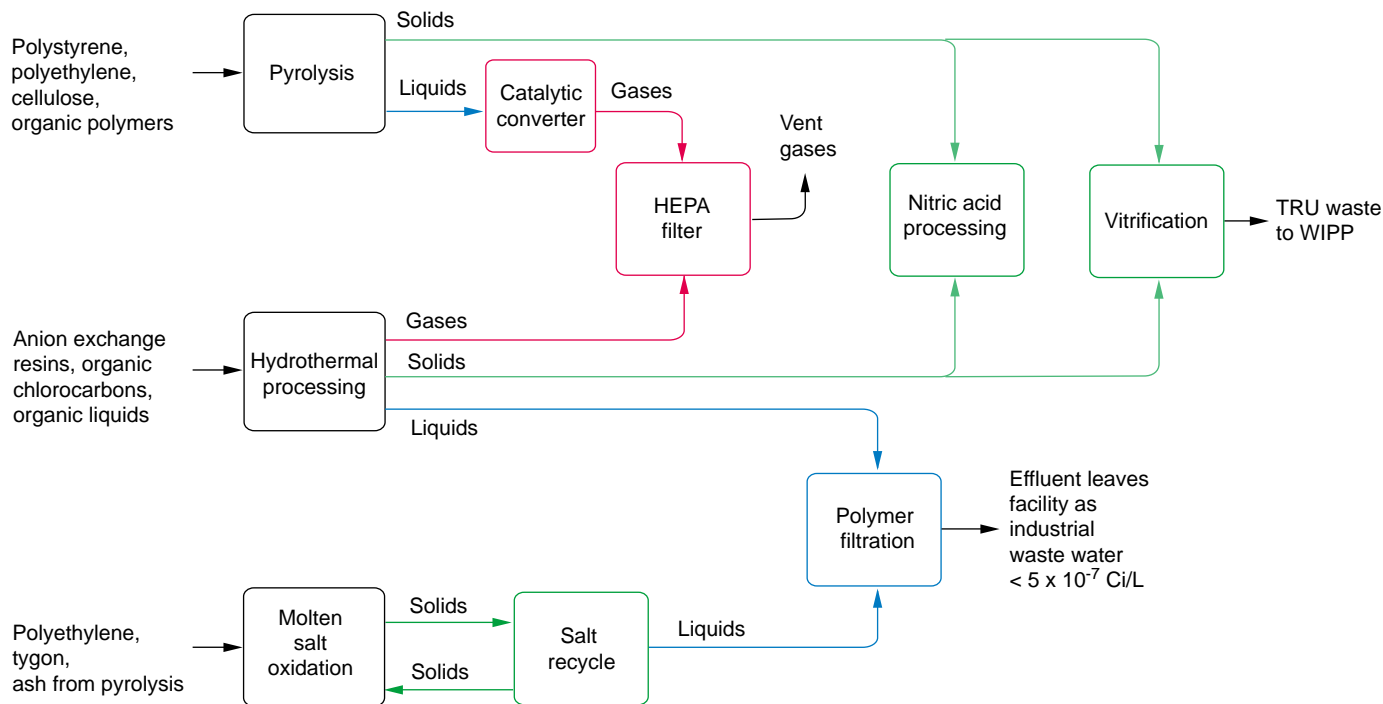

**Figure 3. Combustibles Flow Chart**

Combustible wastes will be treated by several methods. Cellulose, polystyrene, and other selected solids will be treated by pyrolysis. Organic solvents and solids such as ion-exchange resin will be treated by hydrothermal processing. Some plastics and the residual ash from pyrolysis will be treated by molten salt oxidation. The solid, liquid, and gas waste streams from these treatments, however, will be handled similarly. The small volumes of solid byproducts will either be sent to nitric acid processing or be vitrified into glass and shipped to WIPP. All liquid byproducts will be treated by Polymer Filtration™ to meet discharge limits for industrial waste water, with the resulting small volume of solid residue then vitrified as TRU waste. Off gases will be filtered through high-efficiency exhaust systems and discharged to the atmosphere. The filters eventually enter the TRU waste stream and are sent to WIPP.

be loaded with more radionuclides, its overall volume and mass will be about 65 percent that of the cement now used.

We believe these goals are readily achievable. This “90 percent solution” will positively impact every experimental program at TA-55 as well as the overall waste-management program for the facility and the Laboratory. Furthermore, the costs of implementing this solution should be recovered within a few years. Currently, the total life-cycle cost to treat TA-55’s annual TRU waste and dispose it at WIPP is roughly \$5.2 million. If the technologies described here are successfully implemented, the life-cycle cost to dispose of the reduced volume of TRU waste should plummet to about \$0.5 million per year. Beyond the economics of these goals, however, is the

fact that their achievement is a necessary condition for attaining operational and environmental excellence at TA-55.

#### **Treatment of Combustible Wastes.**

The flow chart in Figure 3 summarizes how we intend to reduce radioactive, combustible waste volumes at TA-55. A notable feature of this flow chart is that no low-level solid wastes and only a small volume of concentrated TRU waste are produced. All liquids leave the facility as industrial waste water destined for additional treatment at TA-50.

As indicated in Table I, combustible wastes (for example, rags, plastics, polystyrene cubes, and organic solvents) constitute a significant fraction of the radioactive waste volume generated at TA-55. These wastes are conta-

minated with radioactive elements and strong oxidizers such as nitrates. Hydrothermal processing, enhanced pyrolysis, molten salt oxidation, and mediated electrochemical oxidation are currently the most promising technologies for reducing combustible waste volumes.

Hydrothermal processing is by far the most aggressive of the four methods in destroying organic compounds. It is ideally suited for destroying organic liquids, such as cleaning solvents, and small-particle-size solids, such as anion-exchange resin. It uses water as a solvent but at high enough temperatures and pressures to render it a supercritical fluid. Liquids and preshredded solids are pressure-fed into the hydrothermal reactor along with 30 percent hydrogen peroxide that serves as the oxidizing

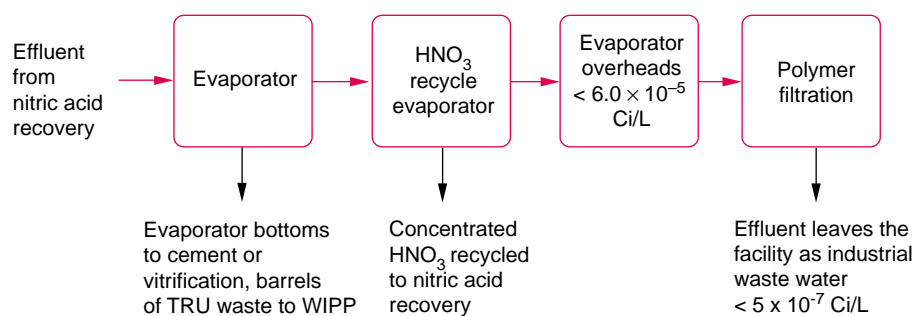

**Figure 4. Flow Chart for Advanced Treatment of Liquid Wastes**

Two technologies will be employed to clean up the liquid waste stream from nitric acid processing. A second evaporator will recycle the nitric acid and prevent nitrates from leaving the facility. Polymer Filtration™ will capture residual plutonium and other actinides from the recycle evaporator’s condensed vapor, so that the radioactive content of the filtration effluent will be reduced to discharge limits for industrial waste water before the effluent is sent to TA-50.

agent. Under hydrothermal conditions, reactions are extremely fast, almost completely destroying the organic matrices in seconds. The box on “Hydrothermal Processing” on page 450 provides more information about this technology.

Enhanced pyrolysis substantially decomposes solid polymeric materials (e.g., polystyrene, polyethylene, and polypropylene). A fully engineered system consists of a pyrolysis step, in which the materials are decomposed into a variety of liquid- and gas-phase constituents, followed by a catalytic conversion step that treats the off gases and liquids by oxidizing them to simple products. The integrated system provides greater than 99 percent conversion of the polystyrene to carbon, water, carbon dioxide, and a small amount of stabilized actinide material. Tests have shown that polyethylene, cellulose, and other organic polymers are equally amenable to this treatment. A fully engineered unit for processing small quantities of polystyrene and cellulose is already installed in a TA-55 glove box. More information on this technology is given in the box on “Enhanced Pyrolysis” on page 451.

In molten salt oxidation, the contaminated waste is oxidized by air in a molten sodium/potassium carbonate

bath. The residual actinides can be recovered from the sodium/potassium carbonate mixture, or the carbonate salt containing the plutonium can be discarded. At TA-55, we plan to use this technology to recover plutonium-238 from combustible process residues. Its implementation will reduce waste volumes and enable us to recycle plutonium-238 for use as a heat or power source in future space missions.

Although not shown in Figure 3, another technology being developed is mediated electrochemical oxidation, which can quickly decompose certain combustible mixed waste, including cation exchange resins, solvents, and plastic bottles. In contrast to hydrothermal processing, this oxidation process operates at low temperature and ambient pressure. In the process, a powerful oxidizing agent, such as Ag(II), is generated electrochemically at the anode of a divided electrochemical cell. When the anolyte solution comes into contact with the waste, its radioactive component is dissolved through reaction with the oxidizing agent. (The insoluble plutonium dioxide is oxidized to the soluble plutonyl ion  $\text{PuO}_2^{2+}$ .) The organic matrix components can also be oxidized to carbon dioxide by reaction with the oxidizing agent. With water serving as an oxygen donor to

complete the reaction, the oxidizing agent is reduced to its original state. The solution is then recycled to the electrochemical cell to regenerate the oxidizing agent, and the process is continued. Because of the cyclic nature of the process, only a small amount of oxidizing agent is required to treat a large amount of combustible waste.

**Treatment of Liquid Wastes.** Research into plutonium complexes in nitric acid has allowed us to design water-soluble molecules that are being deployed in TA-55 for ultrapurifying liquid waste streams. The polymers capture plutonium and other actinides and then are removed from solution by filtration. This technology, developed at Los Alamos and licensed by Polyionics Separation Technologies, Inc., is known as Polymer Filtration™. It is described in the box on page 452.

All liquid that emerges from the treatment of combustible wastes will be treated by Polymer Filtration™, as will the effluent from nitric acid processing. (See Figure 4.) The aqueous liquids that emerge from Polymer Filtration™ will be discharged as industrial waste water. The small volume of polymer that is filtered from solution will be disposed as TRU waste.

Figure 4 also shows that nitric acid recycle technology will be added to the evaporator system at the tail end of the nitric acid processing. Essentially all of the nitric acid will be recycled back to plutonium-recovery processing, and nitrates will no longer leave TA-50.

#### **Treatment of Metallic Wastes.**

Table I reveals that metal constitutes a substantial fraction of the solid waste generated annually at TA-55. This waste consists primarily of discarded stainless steel glove boxes, but it also includes other items such as storage cans and tools. These TRU-waste items can be decontaminated to low-level waste by a process known as electrochemical decontamination. This process uses electrolysis to remove a microscopic layer from metallic surfaces that contains most

of the contamination. A filter then removes actinides from the electrolyte solution so that the latter can be recycled or discarded. The small volume of recovered contaminants is added to processing streams for further treatment or discarded as TRU waste. More information about electrochemical decontamination is given in the box about it on page 453.

## Beyond the 90 Percent Solution

Almost all of the advanced waste treatment and minimization technologies discussed above can or will be implemented at TA-55 over the next three to four years. Integration of those technologies will enable the facility to reduce solid waste volumes and liquid waste activity by 90 percent. However, we will achieve an even higher level of environmental and operational excellence if we can reduce both solid and liquid radioactive waste discharges to near zero.

We can never eliminate TRU waste totally because the very function of much of TA-55's plutonium processing is to remove unavoidable TRU impurities (such as the americium that results from the radioactive decay of plutonium-241). However, the prospects are excellent for eliminating the largest remaining waste stream—the huge volume of industrial waste water that is discharged following Polymer Filtration™—by recycling it into plutonium recovery operations. All process-water discharges from plutonium operations could be eliminated in any next-generation plutonium facility.

Obviously, the most effective strategy for reducing radioactive waste is to avoid its generation. Achieving such a goal will require breakthrough, not incremental, technologies. One possibility is the use of room-temperature ionic liquids (RTILs), which are a new class of solvents. The unique chemical and physical properties of these liquids can augment traditional plutonium pyrochemical processes and possibly

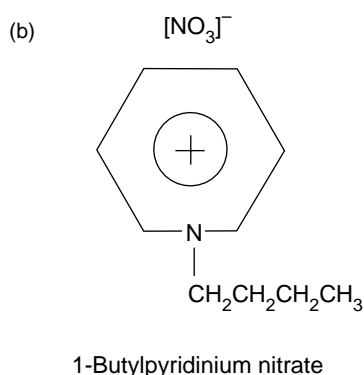
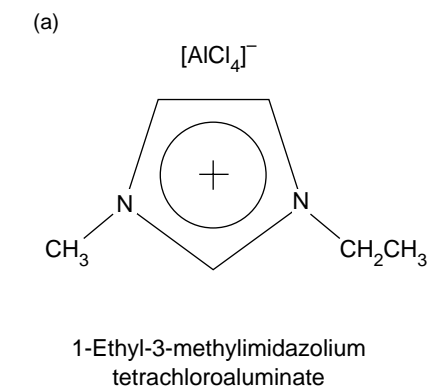

eliminate their waste streams.

RTILs are composed of bulky, low-valent organic cations and inorganic anions (Figure 5). Because the ions are very large and have low charge, they interact only weakly and thus remain liquid at room temperature rather than condensing into well-ordered crystalline solids. Some desirable physical properties of these ionic liquids are high conductivity, low vapor pressure, and the ability to dissolve both organic and inorganic compounds. In addition, the ionic liquids' acidity can be adjusted.

The capabilities of RTILs, coupled with the lack of interference from hydrolysis reactions, create a unique opportunity to obtain detailed information on the fundamental chemical behavior of actinide compounds under conditions far less demanding than those found in pyrochemical processes. Thus, their use could lead to a greater understanding of actinide chemistry that would allow creation of next-generation

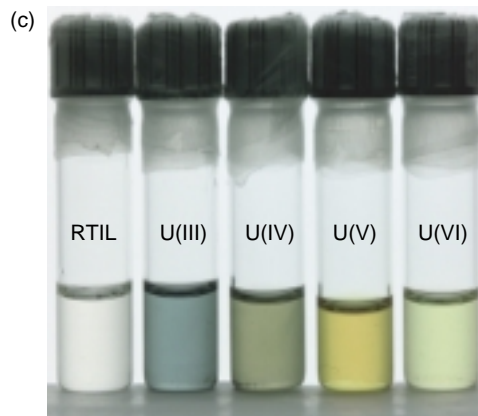

**Figure 5. Room-Temperature Ionic Liquids**

Room-temperature ionic liquids (RTILs) are being investigated as a novel processing medium for actinides. The molecular structure of an RTIL consists of a relatively large cation and anion, as seen in (a) and (b) for two prototypical systems. The leftmost vial in (c) contains the RTIL diagramed in (a). The remaining four vials contain uranium ions that were prepared electrochemically in different oxidation states. The colors arise because of the different oxidation states.

separation and purification processes.

The chemistry of plutonium in RTIL systems is currently being examined. This work has already demonstrated the stability of the Pu(III) and Pu(IV) oxidation states in chloride-rich RTIL solutions. We believe that continued RTIL work will yield valuable thermodynamic data that will help improve high-temperature pyrochemical processes. Further, the ability to fine-tune the properties of RTIL solvents holds the promise of room-temperature electrochemical techniques for purifying and recovering plutonium.

Another promising advance lies in the organometallic chemistry of the actinides. This area of research stems from the discovery that certain actinides (An)—uranium, neptunium, and plutonium—dissolve in ether/iodine mixtures. The resulting  $AnI_3(THF)$  complexes, where THF is tetrahydrofuran, can be used to prepare myriad new compounds and complexes.

For example, one organometallic compound of interest is  $\text{Pu}(\text{C}_8\text{H}_8)_2$ , because it is reported to be diamagnetic. If this claim is confirmed, then we should be able to observe plutonium-239 by analyzing the compound with nuclear magnetic resonance (NMR). (To date, the plutonium-239 nucleus has not been observed by NMR.) If we can use NMR to analyze  $\text{Pu}(\text{C}_8\text{H}_8)_2$ , we will have a new opportunity to study covalent bonding in plutonium.

Another new compound—one that is potentially more relevant for process operations—is  $\text{Pu}[\text{N}(\text{SiMe}_3)_2]_3$ , where Me is a methyl group. This compound sublimates at approximately 50°C. Because of its high vapor pressure, we could use it to develop a chemical processing scheme based on organometallic chemistry. For example, we could dissolve impure plutonium metal in an iodine/THF mixture, use the  $\text{PuI}_3(\text{THF})$  to prepare the volatile  $\text{Pu}[\text{N}(\text{SiMe}_3)_2]_3$  complex, and then purify the  $\text{Pu}[\text{N}(\text{SiMe}_3)_2]_3$  by sublimation. One advantage of such a process is that the plutonium would be dissolved without releasing potentially explosive hydrogen gas. Another is that because the plutonium is purified by sublimation—a physical separation process—all reagents could be recycled or destroyed. However, the most exciting use of  $\text{Pu}[\text{N}(\text{SiMe}_3)_2]_3$  would be in a chemical vapor deposition (CVD) process that could deposit plutonium metal in any shape or thickness. Deposition could potentially eliminate waste-intensive plutonium casting and machining operations.

While we can prepare batches of  $\text{Pu}[\text{N}(\text{SiMe}_3)_2]_3$ , there are many challenges that must be resolved before we can use this compound in a processing scheme. Phase stability in plutonium metal is very sensitive to the amount of carbon present. During the deposition process, carbon from the methyl groups in  $\text{Pu}[\text{N}(\text{SiMe}_3)_2]_3$  could be absorbed by the plutonium metal. One of the challenges of plutonium CVD will be to develop the process to the point that the final plutonium product contains lit-

tle carbon. Furthermore, plutonium for most uses is normally alloyed, and preparing a plutonium alloy with CVD could be difficult. But the rewards of using novel organometallic compounds for processing—safer procedures, minimal residual waste, and minimal need for purification—are sufficient to accept such challenges.

## Summary

When integrated into a unified waste minimization program at TA-55, the advanced technologies we have described promise to radically reduce the radioactivity of our liquid waste streams and reduce the volume of our TRU solid wastes by 90 percent or more. Our ultimate goal, however, is to exceed even this 90 percent solution by engineering a next-generation plutonium facility that discharges close to zero radioactive waste. Such a feat would require that we eliminate the huge volume of industrial waste-water from leaving the building. A new plutonium facility may be built at Los Alamos as early as 2008 and its construction would present an ideal opportunity to implement the new technologies that should help us reach our near-zero-discharge goal. To reduce the TRU-solid waste from plutonium processes to near zero is a more daunting challenge, but we continue to conduct the R&D that we hope will one day produce the needed breakthrough technologies. ■

## Further Reading

- Cleveland, J. M. 1979. *The Chemistry of Plutonium*. La Grange Park, IL: American Nuclear Society.
- Katz, J. J., G. T. Seaborg, and L. R. Morss, eds. 1986. *The Chemistry of the Actinide Elements*. Vol. I and II, London: Chapman and Hall.

**Larry Avens** received his B.S. degree in chemistry from Tennessee Tech University and his Ph.D. in inorganic chemistry from Texas Tech University.



After graduate school he moved directly to the Los Alamos National Laboratory. Plutonium chemical processing and separation science R&D have been Avens' areas of interest. He has four patents and numerous publications in the area. He

has also served on review teams associated with all areas of actinide science.

**Gary Eller** received a B.S. in chemistry from West Virginia University and a Ph. D. in inorganic chemistry from Ohio State University.



After a postdoctoral appointment at Georgia Tech, he moved to Los Alamos and has held positions as post doctoral fellow, staff member, line manager, and project leader. From 1994–1996 he served as a technical advisor to DOE-Hanford in the

high-level waste tanks program and since then has had a leadership role in the national program to stabilize and safely store excess plutonium-bearing materials for up to 50 years. His current technical interests are in the area of actinide, environmental, and fluorine chemistry and the development of scientific information through deployment to solve practical problems in the field.