

NAS-NS
3058

**National
Academy
of
Sciences**

National Research Council

The Radiochemistry of Plutonium

**U.S.
Atomic
Energy
Commission**

COMMITTEE ON NUCLEAR SCIENCE

D. A. Bromley, *Chairman*
Yale University

R. D. Evans, *Vice Chairman*
Massachusetts Institute of Technology

Lewis Slack, *Secretary*
National Research Council

E. C. Anderson
Los Alamos Scientific Laboratory

Jerry B. Marion
University of Maryland

N. E. Ballou
U. S. Naval Radiological Defense
Laboratory

R. L. Platman
Argonne National Laboratory

Martin J. Barger
National Bureau of Standards

Ernest C. Pollard
Pennsylvania State University

C. J. Borkowski
Oak Ridge National Laboratory

Katharine Way
Oak Ridge National Laboratory

Herbert Goldstein
Columbia University

George W. Wetherill
University of California

Bernd Kahn
Taft Sanitary Engineering Center

Marvin E. Wyman
University of Illinois

LIAISON MEMBERS

Harold Glaser
Office of Naval Research

William S. Rodney
National Science Foundation

George A. Kolstad
Atomic Energy Commission

SUBCOMMITTEE ON RADIOCHEMISTRY

Nathan E. Ballou, *Chairman*
U. S. Naval Radiological Defense
Laboratory

Julian M. Nielsen
Battelle Pacific Northwest

G. R. Choppin
Florida State University

G. D. O'Kelley
Oak Ridge National Laboratory

Herbert M. Clark
Rensselaer Polytechnic Institute

E. P. Steinberg
Argonne National Laboratory

Richard M. Diamond
Lawrence Radiation Laboratory

D. N. Sunderman
Battelle Memorial Institute

Jerome Hudis
Brookhaven National Laboratory

John W. Winchester
Massachusetts Institute of Technology

Jere D. Knight
Los Alamos Scientific Laboratory

R. P. Schuman, *Consultant*
Sri Venkateswara University
Tirupati, Andhra Pradesh, India

W. E. Nervi
Lawrence Radiation Laboratory

The Radiochemistry of Plutonium

George H. Coleman

September 1, 1965

UNIVERSITY OF CALIFORNIA
Lawrence Radiation Laboratory
Livermore, California

AEC Contract No. W-7405-eng-48

Subcommittee on Radiochemistry
National Academy of Sciences—National Research Council

Printed in USA. Price \$2.00. Available from the Clearinghouse for Federal Scientific and Technical Information, National Bureau of Standards, U. S. Department of Commerce, Springfield, Virginia.

FOREWORD

The Subcommittee on Radiochemistry is one of a number of subcommittees working under the Committee on Nuclear Science within the National Academy of Sciences - National Research Council. Its members represent government, industrial, and university laboratories in the areas of radiochemistry and nuclear chemistry. Support for the activities of this and other subcommittees of the Committee on Nuclear Science is provided by a grant from the National Science Foundation.

The Subcommittee has concerned itself with preparation of publications, encouraging and supporting activities in nuclear education, sponsoring symposia on selected current topics in radiochemistry and nuclear chemistry, and investigating special problems as they arise. A series of monographs on the radiochemistry of essentially all the elements and on radiochemical techniques is being published. Initiation and encouragement of publication of articles on nuclear education in various subject areas of chemistry have occurred, and development and improvement of certain educational activities (e.g., laboratory and demonstration experiments with radioactivity) have been encouraged and assisted. Radioactive contamination of reagents and materials has been investigated and specific recommendations made.

This series of monographs has resulted from the need for comprehensive compilations of radiochemical and nuclear chemical information. Each monograph collects in one volume the pertinent information required for radiochemical work with an individual element or with a specialized technique. The U. S. Atomic Energy Commission has sponsored the printing of the series.

Comments and suggestions for further publications and activities of value to persons working with radioactivity are welcomed by the Subcommittee.

N. E. Ballou, Chairman
Subcommittee on Radiochemistry

PREFACE

This report has been prepared as one of a series of monographs on the radiochemistry of the elements for the Subcommittee on Radiochemistry of the Committee on Nuclear Science within the National Academy of Sciences. There is included a review of the nuclear and chemical features of plutonium of particular interest to the radiochemist, a discussion of sample dissolution and counting techniques, and finally, a collection of radiochemical procedures for plutonium.

The literature search was completed approximately through September 1964. It is hoped that the bibliography is sufficiently extensive to serve the needs of the radiochemist, but it is to be expected that important references were omitted. The author would appreciate being made aware of such omissions, that they might be included in possible future editions of this monograph.

The author wishes to express thanks to Dr. Earl Hyde, for the loan of his extensive card file on the radiochemistry of plutonium, to Carl Wensrich and the staff of the LRL Library who greatly assisted in the literature search, to Mrs. Shauna Ness who typed the first draft, and to Mrs. Vivian R. Mendenhall who competently edited the final draft and prepared the bibliography.

Finally the author thanks his colleagues at the Lawrence Radiation Laboratory, especially Dr. R. W. Hoff, for reading and criticizing the manuscript, and Dr. P. C. Stevenson for his continued interest and support during the writing of this monograph.

George H. Coleman

Lawrence Radiation Laboratory
University of California
Livermore, California

CONTENTS

	<u>Page No.</u>
I. General Reviews of the Inorganic and Analytical Chemistry of Plutonium	1
II. General Reviews of the Radiochemistry of Plutonium	2
III. Table of Isotopes of Plutonium	3
IV. Chemistry of Plutonium of Special Interest to the Radiochemist	4
A. Metallic Plutonium	4
A.1 Preparation	4
A.2 Physical Properties	4
A.3 Chemical Properties	4
B. Compounds of Pu	6
C. Plutonium Ions in Solution	8
C.1 Oxidation States	8
C.2 Oxidation Reduction Reactions	9
C.3 Disproportionation Reactions	9
C.4 Radiolytic Reduction of Pu Solutions	15
C.5 Hydrolytic Reactions of Plutonium	15
C.6 Pu(IV) Polymer	16
C.7 Complex Ion Formation	17
D. Separation Methods	24
D.1 Co-precipitation and Precipitation	24
D.2 Solvent Extraction Methods	28
D.3 Ion Exchange	75
V. Dissolution of Plutonium Samples for Analysis	96
A. Metallic Plutonium	96
B. Other Compounds	96
C. Biological and Environmental Samples	96
VI. Source Preparation and Counting Methods	96
A. Source Preparation	96
A.1 Direct Evaporation	97
A.2 Electrodeposition	97
A.3 Other Methods	99
B. Counting	99
VII. Safety Considerations	102
A. Radioactive Safety	102
B. Criticality Safety	103
VIII. Collection of Procedures	105
A. Introduction	105
B. Listing of Contents	105
Procedure 1. Determination of Pu in solutions containing large amounts of Fe and Cr	108
Procedure 2. Separation and determination of Pu by TTA extraction	112

CONTENTS (Continued)

	<u>Page No.</u>
Procedures (Continued)	
Procedure 3. Separation and determination of Pu in U - fission product mixtures	114
Procedure 4. Plutonium	116
Procedure 5. Plutonium	118
Procedure 6. Separation of Plutonium from Uranium and Fission Products in Irradiated Reactor Targets	122
Procedure 7. Determination of Pu	124
Procedure 8. Uranium and Plutonium Analysis	126
Procedure 9a. Separation of Plutonium from Irradiated Uranium	129
Procedure 9b. Separation of Plutonium from Uranium Metal	130
Procedure 10. Purification of Plutonium from Uranium and Fission Products	131
Procedure 11. Uranium and Plutonium from Environmental Samples of Soil, Vegetation and Water	132
Procedure 12. Plutonium from Environmental Water Samples	134
Procedure 13. Plutonium from Environmental Water Samples	137
Procedure 14. Separation of Plutonium in Uranium-Plutonium Fission Element Alloys by TBP Extraction from Chloride Solutions	140
Procedure 15. Separation of Pu before Spectrographic Analysis of Impurities Anion Exchange Method	142
Procedure 16. Separation of Plutonium Before Spectrographic Analysis of Impurities. Extraction Chromatography Method Using TBP	144
Procedure 17. Separation of Np and Pu by Anion Exchange	148
Procedure 18. Separation of Np and Pu by Cation Exchange Chromatography	149
Procedure 19. Determination of Plutonium in Urine	150
Procedure 20. Determination of Pu ²³⁹ in Urine (Small Area Electrodeposition Procedure)	153
Procedure 21. Determination of Plutonium in Urine	155
Procedure 22. Determination of Americium in Urine in the Presence of Plutonium	158
Procedure 23. Determination of Plutonium in Urine by Anion Exchange	161
Procedure 24. Determination of Plutonium in Urine by Co-crystallization with Potassium Rhodizonate	164
Procedure 25. Determination of Plutonium in Urine and Bone Ash by Extraction with Primary Amines	166
Glossary	167
References	169

The Radiochemistry of Plutonium

GEORGE H. COLEMAN

Lawrence Radiation Laboratory, University of California
Livermore, California

I. GENERAL REVIEWS OF THE INORGANIC AND ANALYTICAL CHEMISTRY OF PLUTONIUM

1. J. J. Katz and G. T. Seaborg, "The Chemistry of the Actinide Elements," Chap. VII, (John Wiley and Sons Inc., New York, 1957), pp. 239-325.
2. "Plutonium," in Nouveau Traite de Chimie Minerale, Paul Pascal, Genl. Ed. Vol. XV, "Uranium et Transuraniens" (Masson et Cie, Paris, 1962) pp 324-864.
3. "The Complex Compounds of the Transuranium Elements," A. D. Gellman, A. I. Moskvina, L. M. Zaitsev, and M. P. Mefod'eva (Consultants Bureau, New York, 1962 transl. by C. N. and T. I. Turton).
4. M. Taube, Plutonium, (Macmillan Co., New York, 1964; transl. by E. Lepa and Z. Nanowski) Chap. 2, pp 39-84.
5. R. E. Connick, "Oxidation States, Potentials, Equilibria, and Oxidation-Reduction Reactions of Plutonium," in The Actinide Elements, Natl. Nucl. Energy Series, Div. IV, Plutonium Project Record Vol. 14A; Chap. 8, G. T. Seaborg and J. J. Katz, Eds. (McGraw-Hill Book Co., Inc., New York, 1954) pp 221-300.
6. J. C. Hindman, "Ionic and Molecular Species of Plutonium in Solution," in The Actinide Elements, Vol. 14A, Chap. 10, pp 371-434.
7. B. B. Cunningham, "Preparation and Properties of the Compounds of Plutonium," in The Actinide Elements, Vol. 14A, Chap. 10, pp 371-434.
8. C. F. Metz, "The Analytical Chemistry of Plutonium," Anal. Chem. 29, 1748 (1957).
9. D. Nebel, "The Analytical Chemistry of Plutonium," Joint Publications Research Service NYC, AEC Report JPRS-11689. transl. from Chem. Tech. Leipzig, 13 522 (1961).
10. P. N. Palei, "Analytical Chemistry of the Actinides," transl. by S. Botcharsky, AERE-LIB/TRANS-787. (See also J. Anal. Chem. USSR 12, 663 (1957).)
11. A. J. Moses, "The Analytical Chemistry of the Actinide Elements" (Macmillan Co., New York, 1963).
12. A. Schiffers, "Plutonium, seine chemischen und physikalischen Eigenschaften," Chemiker Zeit. 86, 656 (1962).
13. K. W. Bagnall, "The Transuranium Elements," Sci. Progr. (London) 52, 66-83 (1964).
14. V. I. Kuznetsov, S. B. Savvin, and V. A. Mikhailov, "Progress in the Analytical Chemistry of Uranium, Thorium and Plutonium," Russ. Chem. Rev. 29, 243 (1960).
15. R. Kraft, C. J. Wensrich and A. L. Langhorst, "Chemical Analysis of Plutonium and Plutonium Alloys: Methods and Techniques," Lawrence Radiation Laboratory, University of California, Livermore, Calif. UCRL-6873, 1962.

II. GENERAL REVIEWS OF THE RADIOCHEMISTRY
OF PLUTONIUM

16. E. K. Hyde, "Radiochemical Separations of the Actinide Elements," in The Actinide Elements, National Nuclear Energy Series, Div. IV, Plutonium Project Record Vol. 14A, G. T. Seaborg and J. J. Katz, Eds. (McGraw-Hill Book Co., New York, 1954) Chap. 15.
17. E. K. Hyde, "Radiochemical Separations Methods for the Actinide Elements," in Proc. of the International Conference on the Peaceful Uses of Atomic Energy, Geneva, 1955, A/CONF. 8/7, (United Nations, New York, 1956) pp 281-303, Paper 728.
18. M. P. Faugeras, "Separation et Purification des Isotopes, (of Plutonium)," in Nouveau Traite de Chemie Minerale, Paul Pascal, Gen. Ed., Vol. IV, "Uranium et Transuraniens," (Masson et Cie, Paris, 1962) pp 339-385.
19. M. Taube, Plutonium (Macmillan Co., New York, 1964; transl. by E. Lepa and Z. Nanowski). "Radiochemical Methods of Analysis," pp 78-84.

III - TABLE OF ISOTOPES OF PLUTONIUM*

Isotope	Half Life	Specific Activity (d/m/ μ g)	Type of Decay	α Particle Energy (MeV)	Method of Preparation
Pu ²³²	36 min	--	α 2%, EC 98%	6.58	U ²³⁵ + 100 MeV α particles
Pu ²³³	20 min	--	α 0.1%, EC 99 + %	6.30	U ²³³ + 40 MeV α particles
Pu ²³⁴	9.0 hr	--	α 6%, EC 94%	6.19	U ^{233, 235} + 40 MeV α particles Daughter of Cm ²³⁸
Pu ²³⁵	26 min	--	α 3×10^{-3} %, EC 99 + %	5.85	U ^{233, 235} + 20-30 MeV α particles
Pu ²³⁶	2.85 yr	1.18×10^9	α	5.763 (69%) 5.716 (31%)	U ²³⁵ + 40 MeV α particles Daughter Np ²³⁶ Daughter Cm ²⁴⁰
Pu ²³⁷	45.6 days	--	α 0.003%, EC 99 + %	5.36 (79%) 5.65 (21%)	U ²³⁵ + 40 MeV α particles
Pu ²³⁸	86.4 yr	3.88×10^7	α	5.495 (72%) 5.452 (28%)	U ²³⁸ + deuterons Daughter Cm ²⁴² Pu ²³⁹ + high energy neutrons Np ²³⁷ + neutrons
Pu ²³⁹	24,360 yr	1.36×10^5	α	5.147 (73%) 5.134 (17%) 5.096 (10%)	U ²³⁸ + neutrons
Pu ²⁴⁰	6,580 yr	5.00×10^5	α	5.162 (76%) 5.118 (24%)	U ²³⁸ + neutrons Pu ²³⁹ + neutrons Daughter of Cm ²⁴⁴
Pu ²⁴¹	13.0 yr	2.57×10^8	α 4×10^{-3} %, β^- 99 + %	4.89	U ²³⁸ + neutrons Daughter of Cm ²⁴⁵ U ²³⁸ + α particles
Pu ²⁴²	3.79×10^5 yr	8.65×10^3	α	4.898 (76%) 4.858 (24%)	U ²³⁸ + neutrons Am ²⁴¹ + neutrons
Pu ²⁴³	4.98 hr	--	β^-	---	Pu ²⁴² + neutrons
Pu ²⁴⁴	7.6×10^7 yr	42.8	α	---	Am ²⁴³ + neutrons Pu ²⁴² + neutrons
Pu ²⁴⁵	10.6 hr	--	β^-	---	Pu ²⁴⁴ + neutrons
Pu ²⁴⁶	10.85 days	--	β^-	---	U ²³⁸ + neutrons (thermonuclear explosion)

* The data for this table were taken from the recent review of Hyde.¹⁹² This work should be consulted for further details and references to the literature.

IV. CHEMISTRY OF PLUTONIUM OF SPECIAL INTEREST TO THE RADIOCHEMIST

A. Metallic Plutonium

A.1 Preparation

Plutonium metal is most commonly prepared by the reduction of a halide by a more electropositive metal such as calcium. Connor⁹⁸ has compared various combinations of halide and reducing metal and found that the only satisfactory reactions were PuF_3 , PuF , and PuCl_3 reduced with Ca metal. Harmon and Reas¹⁶⁴ and Orth³⁰⁶ have discussed the conversion of Pu salts to metal on an industrial scale, while Anselin, et al.³⁰ describe a method for the conversion on a gram scale.

A.2 Physical Properties

Pu is a typically silver-white appearing metal which has a number of peculiar physical properties. The metal undergoes a total of five allotropic modifications below the melting point, two of which have negative coefficients of thermal expansion. Table IV-1 summarizes the more important physical properties.

A.3 Chemical Properties

Pu is a very reactive metal. The potential for the couple $\text{Pu} = \text{Pu}^{+++} + e^-$ is 2.03 volts, which places it between scandium (Sc) and thorium (Th) in the EMF series of elements. Pu oxidizes more readily than does U, and resembles cerium (Ce) in its reactions in air. Superficial oxidation of a freshly prepared surface occurs in a few hours in normal air. The oxide is more or less adherent, and in several days the oxidation reaction accelerates until finally the oxidation to PuO_2 is complete. However, the oxide coating protects the underlying metal in dry air, and the oxidation proceeds more slowly. Pu metal is attacked at elevated temperatures by most gases; H_2 , N_2 , halogens, SO_2 , etc. Pu metal dissolves easily and rapidly in moderately concentrated HCl and other halogen acids.

Pu forms intermetallic compounds with intermediate solid solutions with most metallic elements. However, simple eutectic mixtures are usually made with the group Va and VIa metals, and very little solubility in either the liquid or solid state is exhibited by alkali and alkaline earth metals.

The behavior of Pu toward various solutions is given in Table IV-2.

TABLE IV-1. Physical Properties of Plutonium Metal*

A. Appearance	Silvery white; quickly oxidizes in air						
B. Melting point	639.5°C						
C. Boiling point	3508 ± 19°C						
D. Properties of the various allotropic modifications	α	β	γ	δ	δ^-	ϵ	
Transition temperature to next higher phase (°C)	125	210	315	460	475	640	
Density (g/cm ³) (at T°C)	19.82 (25)	17.82 (133)	17.14 (235)	15.92 (320)	16.00 (465)	16.48 (510)	
Crystal structure	Monoclinic	Body-centered monoclinic	Orthorhombic	Face-centered cubic	Body-or face-centered tetragonal	Body-centered cubic	
Coefficient of linear expansion (°C ⁻¹) (in temp range °C)	67 × 10 ⁻⁶ (80-120)	41 × 10 ⁻⁶ (160-200)	35 × 10 ⁻⁶ (220-280)	-8.6 × 10 ⁻⁶ (340-440)	(-----)	15 (490-550)	
Latent heat of transformation to next higher phase (cal/g-atom)	958	140	156	17	470	940	
E. Electrical resistivity (at 25°C)	68.5μΩ-cm						
F. Self heating coefficient	(1.923 ± 0.019) × 10 ⁻³ W/g						
G. Ionization potential	5.1 ± 0.5 eV						

*Data compiled from various secondary sources, including Francis,¹³⁷ Coffinberry and Waldron,⁹⁴ and Jette.²¹¹

TABLE IV-2. Behavior of Pu Metal in Various Solutions

Solution	Behavior
H ₂ O	Very slowly attacked
Salt water	Rapidly attacked after induction period
HCl, HI, HBr	Rapid dissolution
Acetic acid	No visible reaction in concentrated acid; slow dissolution in dilute acid
HClO ₄	Rapid dissolution in concentrated acid
HNO ₃	Very slow attack, limited principally to the oxide coating. The surface is passivated
H ₃ PO ₄	Rapid dissolution in concentrated acid
H ₂ SO ₄	Very slow attack with similar behavior to HNO ₃
Sulfamic acid	Rapid dissolution

B. Compounds of Pu

Pu forms compounds with a large number of elements. Compounds of Pu in the II through VI oxidation states are known. Cunningham,⁷ and Faugeras and Heuberger¹²⁸ describe the preparation and properties of those compounds which have been prepared. Gel'man, et al.,³ emphasize the data on complex compounds and attempt to systematize the data by relating the structures and coordination numbers of the complex compounds to other actinide elements, as well as to other regions of the periodic table.

The compounds of the III, IV and VI oxidation states are the ones with which the radiochemist deals, and the insoluble compounds are of primary interest. Of these the insoluble hydroxides, fluorides, and oxalates, phosphates and peroxides of the III and IV states are of major interest in precipitation and co-precipitation reactions and are described in more detail in that section. One of the great complicating factors in Pu chemistry is the formation of a polymeric form by hydrolysis in dilute acid or neutral solutions. The polymeric form can be quite intractable in many reactions, and may be difficult to destroy. The section on hydrolytic reactions of Pu gives details.

Table IV-3 lists solubility information for the more stable Pu compounds which have been prepared.

TABLE IV-3. Solubility of Plutonium Compounds*

		Reference
PuH ₂ -PuH ₃	s. ** HCl, H ₂ SO ₄ , i. HNO ₃ , decomp. in H ₂ O	
PuF ₃ -PuF ₄	decomposes in fluoride complexing agents; e. g. H ₃ BO ₃ i. H ₂ O, mineral acids	
PuO ₂ F ₂	i. H ₂ O	27
NaPuF ₅	sl. s. dilute HNO ₃ HF, i. NaF-HF s. H ₃ BO ₃	
PuF ₆	decomposes violently in H ₂ O	
PuCl ₃	s. H ₂ O, acid	
Cs ₂ PuCl ₆	s. acid, H ₂ O	
PuBr ₃	s. H ₂ O	

TABLE IV-3 (Cont.)

	Reference
PuI ₃	s. H ₂ O
Pu(IO ₃) ₃	s. HNO ₃ , i. H ₂ SO ₄ -KIO ₃ , excess HIO ₃
Pu(IO ₃) ₄	s. HNO ₃ , decomposed in H ₂ SO ₃
PuO ₂	s. slowly in boiling mineral acids; reaction speeded by fusion with NaHSO ₄ or HF added to HNO ₃ ; solubility is more difficult if ignited above 500°
Pu(OH) ₃	s. mineral acid
Pu(OH) ₄	s. mineral acid
PuO ₂ (OH) ₂	s. mineral acid, K _{sp} = 1.8 × 10 ⁻²³ 264
Pu peroxide	s. conc. HNO ₃ , H ₂ SO ₄
MPu(SO ₄) ₂ , M=Na, K, Rb, Cs, NH ₄	i. M ₂ SO ₄ -H ₂ SO ₄ , s. H ₂ O alcohol
Pu(SO ₄) ₂	s. H ₂ O, i. alcohol
M ₄ Pu(SO ₄) ₄ , M=K, Rb, NH ₄	s. H ₂ O, i. alcohol
Pu(NO ₃) ₄	s. H ₂ O, colloidal Pu forms in aqueous soln. s. HNO ₃ , ether, acetone
M ₂ Pu(NO ₃) ₆ , M=K, Rb, Cs, Tl	i. conc. HNO ₃ , s. H ₂ O, dil acid
PuPO ₄	s. hot conc. mineral acid; sl. s. H ₃ PO ₄ , NaOH; i. HC ₂ H ₃ O ₂
Pu(HPO ₄) ₂ · xH ₂ O	
Pu ₂ H(PO ₄) ₃ · yH ₂ O	i. mineral acid - H ₃ PO ₄
Pu ₃ (PO ₄) ₄ · zH ₂ O	
PuC, Pu ₂ C ₃	s. HCl, H ₂ SO ₄ , i. cold conc HNO ₃ s. hot conc. HNO ₃ -NaF ₂
PuOCO ₃	i. H ₂ O, sl. s. cold mineral acids
K ₆ [Pu(CO ₃) ₅] · mH ₂ O	
K ₄ [Pu(CO ₃) ₄] · mH ₂ O	i. alcohol
K ₁₂ [Pu(CO ₃) ₈] · mH ₂ O	
M ₄ [PuO ₂ (CO ₃) ₃], M=K, NH ₄	s. Na ₂ CO ₃ , LiHCO ₃ , sl. s. H ₂ O, s. mineral acid
HPuFe(CN) ₆ · xH ₂ O	i. HCl
PuFe(CN) ₆	i. HCl
Pu ₃ [Fe(CN) ₆] ₄ · xH ₂ O	i. HCl
(PuO ₂) ₃ [Fe(CN) ₆] ₂ · xH ₂ O	i. HCl
Pu ₂ (C ₂ O ₄) ₃ · xH ₂ O	i. H ₂ O, s. mineral acid; sl. s. K ₂ C ₂ O ₄ , (NH ₄) ₂ C ₂ O ₄
Pu(C ₂ O ₄) ₂ · 6H ₂ O	i. H ₂ O, s. H ₂ SO ₄ , HNO ₃ , HClO ₄ sl. s. acid-K ₂ C ₂ O ₄ , NH ₂ C ₂ O ₄ minimum s. in 1.5 M HNO ₃ - 0.025 M H ₂ C ₂ O ₄ 264
PuO ₂ (C ₂ O ₄) · 3H ₂ O	s. mineral acid; sl. s. acid - H ₂ C ₂ O ₄
NaPuO ₂ (C ₂ H ₃ O ₂) ₂	sl. s. hot H ₂ O, s. acid

* Compiled primarily from the reviews of Cunningham⁷ and Faugeras and Heuberger¹²⁸
 Unless otherwise specified, the data are taken from these reviews.

** The following abbreviations are used:

- s. soluble
- i. insoluble
- sl. s. slightly soluble
- conc. concentrated
- dil. dilute

C. Plutonium Ions in Solution

C.1 Oxidation States

Plutonium in aqueous solution exists in the +3, +4, +5, or +6 oxidation states, resembling both uranium (U), neptunium (Np) and americium (Am) in this respect.

The formal oxidation potential diagrams for Pu in acid and basic solution are taken from Latimer.²⁵⁰

ACID SOLUTION

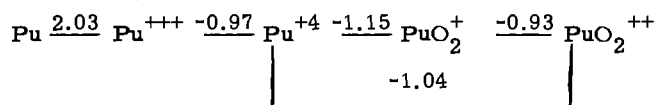

BASIC SOLUTION

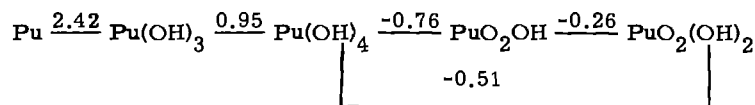

Formal oxidation potentials for Pu couples in various 1 M solutions are shown in Table IV-4. The displacements of the potentials are due to the complex-forming tendencies of the anions with Pu.

TABLE IV-4. Formal Potentials for Pu Couples in Various 1 M Solutions

	Pu(III)-Pu(IV)	Pu(IV)-Pu(VI)	Pu(III)-Pu(VI)	Pu(V)-Pu(VI)
HClO ₄	-0.982	-1.043	-1.023	-0.92
HCl	-0.970	-1.052	-1.024	-0.912
HNO ₃	-0.92	-1.05	-1.04	-----
H ₂ SO ₄	-0.74	-1.2-1.4	-----	-----

The lower oxidation states become more stable in the actinide series from U to Am, and correspondingly the higher oxidation states become more difficult to attain. This effect is illustrated in Table IV-5, which shows the free energies of formation of various actinide ions.

TABLE IV-5. Free Energy of Formation of Actinide Ions (kcal/mole)

	M ⁺⁺⁺	M ⁺⁺⁺⁺	MO ₂ ⁺	MO ₂ ⁺⁺
U	-124.4	-138.4	-237.6	-236.4
Np	-128.4	-124.9	-221.0	-194.5
Pu	-140.5	-118.2	-204.9	-183.5
Am	-160.5	-110.2	(-194.5)	-156.7

Thus the most stable +3 ion in this series is Am⁺⁺⁺, while the most stable +6 ion is UO₂⁺⁺. Pu is the first member of this series in which the tripositive state is stable enough in aqueous solution to be useful in separation chemistry.

This fact is of supreme importance in the radiochemistry of Pu, since Pu can be selectively maintained in either the +3 or +4 oxidation states in separation schemes. Advantage is taken of this ability in many of the collected procedures in section VI.

The oxidation-reduction behavior of Pu is complicated by several factors:

(1) PuO₂⁺ disproportionates into Pu⁺⁴ and PuO₂⁺⁺ and under certain conditions Pu⁺³, Pu⁺⁴, PuO₂⁺, and PuO₂⁺⁺ can all exist in equilibrium; Pu⁺⁴ is a small, highly charged ion and therefore undergoes extensive hydrolysis at low acidity and forms many stable complex ions. This tendency is a dominant feature of Pu(IV) chemistry. Pu(IV) forms a long-chain compound or polymer by hydrolytic reactions. Pu(IV) polymer is one of the more unpleasant aspects of Pu chemistry from the standpoint of the radiochemist.

C.2 Oxidation-Reduction Reactions

Table IV-6 lists reagents and conditions to effect changes in oxidation state for Pu ions. It must be emphasized that a relatively small change in conditions may produce a large change in the equilibrium, and that some of the oxidation-reduction reactions may proceed beyond those listed. Therefore, the listed reactions should be taken as a guide only.

In general, the change in oxidation state between +3 and +4 is rapid, since only one electron is involved in this change. Similarly PuO₂⁺ and PuO₂⁺⁺ changes are rapid. Changes in the oxidation state of Pu which involve the making or breaking of a Pu-O bond are usually slower. However, Hindman,¹⁸⁴ in a general review of the kinetics of actinide oxidation-reduction reactions, gives examples of reactions involving M-O bonds which proceed as rapidly as some involving only electron transfer. Newton and Rabideau³⁰² have also reviewed the kinetics of actinide oxidation-reduction reactions.

C.3 Disproportionation Reactions

The potentials of the various Pu couples are such that appreciable quantities of several oxidation states may exist in equilibrium. Pu(IV) and Pu(V) are both unstable with respect to disproportionation into higher and lower oxidation states in weakly acid, uncomplexed media. There are several important equilibria which must be considered for an understanding of Pu oxidation-reduction chemistry.

TABLE IV-6. Oxidation-Reduction Reactions of Plutonium Ions*

A. Pu(III) → Pu(IV)

Reagents	Solution	Temp.	Rate	Reference
BrO ₃ ⁻	Dilute acid	R.T.**	Very rapid	
Ce ⁺⁴	1.5 M HCl	R.T.	Very rapid	
	6 M HCl,	R.T.	Very rapid	235
	dilute H ₂ SO ₄	R.T.	Very rapid	235
Cl ₂	0.5 M HCl	R.T.	Slow (t _{1/2} > 9 hr)	
H ₂ O ₂	R-6 M HCl	R.T.	Equilibrium at 90% Pu(IV) in several hours	145
	4-8 M HClO ₄	R.T.	Equilibrium at 80-90% Pu(IV) in several hours	145
Cr ₂ O ₇ ⁼	Dilute acid	R.T.	Extremely rapid	
HIO ₃	Dilute acid	R.T.	Extremely rapid	
MnO ₄ ⁻	Dilute acid	R.T.	Extremely rapid	79
O ₂	0.5 M HCl	R.T.	No oxidation in 42 hr.	
		97° C	2.5% oxidized in 4 hr, more rapid in higher	
NO ₂ ⁻	HNO ₃	R.T.	Very rapid	63
	0.4 - 2 M HNO ₃ , Fe(II) Sulfamate,	R.T.	Complete in few minutes	63
	0.1 M HNO ₂			

* This table is an enlarged version of the one given by Katz and Seaborg¹ which was compiled from data given by Connick.⁵ Unless otherwise specified, the data were obtained from this source.

** R. T. = room temperature.

B. Pu(IV) → Pu(III)

Reagents	Solution	Temp.	Rate	Reference
Hydroquinone	Dilute HNO ₃	R.T.	Rapid	
H ₂ , Pt	0.5 M - 4.0 M HCl	R.T.	> 99% reduced in 40 min	
I ⁻	0.1 M KI + 0.4 M HCl	R.T.	t _{1/2} = 2 min	
HSO ₃ ⁻	0.05 M NH ₄ HSO ₃ , 0.3 M HNO ₃	R.T.	t _{1/2} = ~2 min	65
NH ₃ OH ⁺	0.5 M HNO ₃ + 0.1 M NH ₃ OH ⁺	R.T.	t _{1/2} ~40 min	
	NH ₂ OH·HCl, HCl	----	-----	
Zn	0.5 M HCl	R.T.	Rapid	
SO ₂	1 M HNO ₃	R.T.	t _{1/2} < 1 min	
Ti ⁺⁺⁺	6 M HCl,	R.T.	Very rapid	235
	dilute H ₂ SO ₄	R.T.	Very rapid	235
	1 N HNO ₃ + 1 N H ₂ SO ₄	R.T.	Rapid	103
Cr ⁺⁺	Dilute HCl or H ₂ SO ₄	R.T.	Rapid	235, 449
Ascorbic	HNO ₃		Rapid	416, 402
Acid	0.5 M HNO ₃ , 0.01 M Ascorbic acid	R.T.	Rapid	65
	6 M HNO ₃ 0.1 M Ascorbic acid, Fe(II) Sulfamate	R.T.	Rapid	65
H ₂ O ₂	7.5 M HCl	R.T.	Complete in several hr	145

C. Pu(IV) → Pu(VI)

Reagents	Solution	Temp.	Rate	Reference
NaBiO ₃	5 M HNO ₃ + 0.84 g/liter	R.T.	Complete in less than 5 min	
BrO ₃ ⁻	0.1 M BrO ₃ ⁻ , 1 M HNO ₃	85° C	99% oxidized in 4 hr	
Ce ⁺⁴	0.1 M Ce ⁺⁴ , 0.5 M HNO ₃	R.T.	Complete in 15 min	
HOCl	pH 4.5, -8.2, 0.1 M HOCl	80° C	Complete in 15 min	
	45% K ₂ CO ₃	40° C	Complete in 5-10 min	
H ₅ IO ₆	0.02 M H ₅ IO ₆ , 0.22 M HNO ₃	R.T.	t _{1/2} = 100 min	
MnO ₄ ⁻	1 M HNO ₃ , 0.001 M MnO ₄ ⁻	25° C	t _{1/2} = 50 min	
O ₃	Ce ⁺³ or Ag ⁺ catalyst	0° C	Complete in 30 min	
	0.25 M H ₂ SO ₄ , no catalyst	19° C	Complete in 15 hr	150
	0.25 M H ₂ SO ₄ , no catalyst	65° C	Complete in 1-1/2 hr	150
	2 N HCl, no catalyst	R.T.	2-8 hr depending on concentration of Pu	275, 276
Ag ⁺⁺	Ag ⁺ + S ₂ O ₈ ⁼ , 1.1 M HNO ₃	25° C	Complete in 1 min	
	0.5 N H ₂ SO ₄ , Solid Ag(II)	0		361, 39
Cr ₂ O ₇ ⁼	0.05 M HClO ₄ , dilute H ₂ SO ₄	25° C R.T.	t _{1/2} = 15 min Complete in 9 hr	129
HNO ₃	0.55 M HNO ₃ , 1 × 10 ⁻³ M Pu	98 ± 1°	80% complete in 2 hr	301
Cl ₂	0.03 M H ₂ SO ₄ + saturated Cl ₂	80° C	t _{1/2} = 35 min	
	0.1 M HClO ₄ , 0.025 M Cl ₂ , 0.056 M Cl ⁻	22° C	t _{1/2} = 2 hr	
Electrolysis	0.5 M HClO ₄	R. T.	Complete in 30 min	454

D. Pu(VI) → Pu(IV)

Reagents	Solution	Temp.	Rate	Reference
HCOOH	HNO ₃	R.T.	Slow	
C ₂ O ₄ ⁼	0.02 <u>M</u> H ₂ C ₂ O ₄	75° C	t _{1/2} = 60 min	
I ⁻	2.3 <u>M</u> HI, 3.1 <u>M</u> HNO ₃	?	Rapid	
Fe ⁺⁺	HCl	R.T.	Rapid	
	2-6 <u>M</u> HNO ₃ , 1 <u>M</u> Ferrous Sulfamate	R.T.	Rapid	75
	2-4 <u>N</u> H ₂ SO ₄	R.T.	Fairly fast	361, 39
NO ₂ ⁻	HNO ₃	?	?	96
H ₂ O ₂	HNO ₃	R.T.	Fast, reduction continues to PU(III)	295

E. Pu(V) → Pu(IV)

Reagents	Solution	Temp.	Rate	Reference
HNO ₂	-----	R.T.	Slow	
NH ₃ OH ⁺	0.5 <u>M</u> HCl, 0.015 <u>M</u> NH ₃ OH ⁺	R.T.	Slow	

F. Pu(VI) → Pu(V)

Reagents	Solution	Temp.	Rate	Reference
I ⁻	pH 2	R.T.	Instantaneous	
NH ₂ NH ₃ ⁺	0.5 <u>M</u> HCl, 0.05 <u>M</u> NH ₂ NH ₃ ⁺	25° C	t _{1/2} = 180 min	
SO ₂	pH -2	25° C	Complete in 5 min	
Fe ⁺⁺	0.05 - 2 <u>M</u> HClO ₄ , μ = 2	0-25° C	-----	301

The first of these is the disproportionation of Pu(IV) according to the reaction

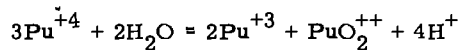

for which the concentration equilibrium constant may be written

$$K_c = \frac{(\text{Pu}^{+3})^2 (\text{PuO}_2^{++}) (\text{H}^+)^4}{(\text{Pu}^{+4})^3}$$

Table IV-7 lists K_c for this reaction under similar conditions of acidity and ionic strength for different acids.

TABLE IV-7. Concentration Equilibrium Constant for the Disproportionation of Pu⁺⁴ in Various Acids at 25°C*

Acid	H ⁺ ≈ 1.0 M; μ=1.0
HClO ₄	9 × 10 ⁻³
HCl	2 × 10 ⁻³
HNO ₃	4 × 10 ⁻⁷
H ₂ SO ₄	Very low**

* Taken from Gel'man et al.³

** Appreciable quantities of Pu(III), Pu(IV), and Pu(VI) cannot exist together in H₂SO₄ solutions.

These data show that strong influence of the anionic medium on the equilibrium. The equilibrium is shifted markedly to the left even at these low ionic strengths by the strong complexes formed by Pu(IV). Conversely, the equilibrium is shifted to the right by lowering the concentration of the acid and complex forming anion, at least until the onset of hydrolysis at pH 1-1.5. The hydrolytic reactions again stabilize Pu(IV).

The disproportionation reaction probably occurs as a series of bimolecular reactions. According to Connick and McVey,¹⁰⁰ the reaction path may be

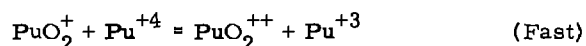
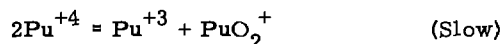

The first reaction is slow because Pu-O bond formation is involved, while the second reaction only requires electron transfer. The rate of the first reaction is second-order in Pu(IV) concentration and inverse third-order in H⁺ concentration. The following reaction sequence is consistent with these discrepancies

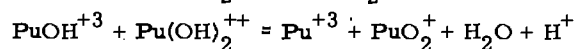
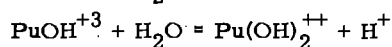
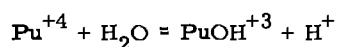

Crocker¹⁰⁶ determined the relative amount of each oxidation state present over a wide range of temperature and HNO₃ concentration. He found that the minimum concentration of HNO₃ to prevent formation of Pu(VI) in a 4 × 10⁻³ M Pu(IV) solution is 1.5 M, while at 98°C the required concentration of acid is 8 M.

The second important equilibrium is the disproportionation of Pu(V), which is unstable in moderately acid solution with respect to the reaction

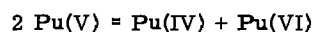

Connick⁹⁹ describes this overall reaction as proceeding by either of the two slow reactions

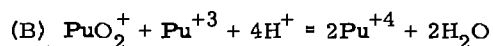
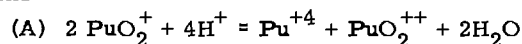

followed by the fast reaction

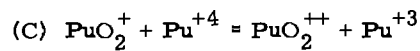

Reactions A and B involve the breaking of Pu-O bonds, while C does not. Reaction A is probably only important until sufficient Pu^{+3} is formed for reaction B to occur, since B is kinetically more probable than A.

These disproportionation reactions may be involved in oxidation-reduction reactions by other reagents. Instead of direct oxidation or reduction, the disproportionation reaction can occur first, followed by direct oxidation or reduction of the appropriate product.

C.4 Radiolytic Reduction of Pu Solutions

The alpha particles emitted in the decay of Pu^{239} supply enough energy to the medium to decompose solutions of Pu^{239} by radiolysis. The radiolysis products then oxidize or reduce the Pu, depending on the nature of the solution and the oxidation state of the Pu. This effect was first described by Kasha and Shelton²¹⁵ who noticed 0.6% reduction of Pu(VI) to Pu(IV) per day in perchloric acid solution which was independent of acidity over a range 0.1 to 2 M. The rate of reduction in HCl was considerably less. In both cases the reaction is slow enough to allow the equilibrium quantities of the various oxidation states to be present. The reduction of Pu(VI) probably proceeds first to Pu(V), and the lower states obtained by disproportionation of this ion.

Rabideau *et al.*³²⁶ confirmed the above qualitative results concerning the relative rates of HClO_4 and HCl reduction and found that the situation is complicated by the production of Cl^- in HClO_4 solutions and Cl_2 in HCl solutions. Also, if Br^- is added to HClO_4 solutions, a net oxidation instead of reduction occurs if the mean oxidation number is initially approximately 4.

Page³⁰⁸ and Page and Haissinsky³⁰⁹ found that the rate of reduction depended very strongly on the nature of the anion in a study of external gamma-radiation induced reduction of Pu(VI). The rates of reduction decreased in the order $\text{ClO}_4^- \approx \text{SO}_4^{--} > \text{Cl}^- \gg \text{NO}_3^-$. These results presumably also apply to auto-reduction by alpha particles.

Popov *et al.*³²⁰ on the other hand found only oxidation by irradiation of HNO_3 solutions of Pu with external x-radiation. The rate of oxidation decreased with an increase of NO_3^- and total acidity.

The lesson to the radiochemist is clear: The stated oxidation states of old Pu solutions, particularly low acidity HClO_4 and H_2SO_4 solutions, should be viewed with suspicion.

C.5 Hydrolytic Reactions of Plutonium

Pu in all of its oxidation states exists in aqueous solutions as highly charged ions and therefore undergoes hydrolysis reactions in dilute acid solutions. The tendencies for these ions to undergo hydrolysis is dependent on the charge and ionic radius. The tendency thus increases with increasing atomic number for all the oxidation states of the actinide series and in the case of Pu increases in the order $\text{PuO}_2^{++} < \text{Pu}^{+++} < \text{Pu}^{+4}$.

Pu^{+4} has approximately the same tendency to hydrolyze as Ce^{+4} but less than that of Hf^{+4} and Zr^{+4} .

The constant for the first displacement of a proton from the hydration sphere, along with the solubility product for the hydroxide of the various Pu ions, is given in Table IV-8. In the case of Pu^{+3} and Pu^{+4} , the hydrolysis reaction may be written

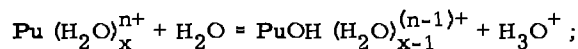

or in the case of PuO_2^{++}

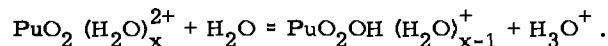

PuO_2^{++} hydrolyzes to a greater extent than a simple dipositive ion of the same radius, showing the effect of the highly charged central Pu ion.

TABLE IV-8. First Hydrolysis Constants and Solubility Products for Plutonium Ions.

Ion	Hydroxide	P_{K_H}	K_{SP} of Hydroxide	Ref.
Pu^{+3}	$\text{Pu}(\text{OH})_3$	7.22 ($\mu = 0.069$, HClO_4)	2×10^{-20}	*
		7.37 ($\mu = 0.034$, HCl)	7×10^{-56}	*
Pu^{+4}	$\text{Pu}(\text{OH})_4$	1.27 ($\mu = 2.0$)		
PuO_2^{++}	$\text{PuO}_2(\text{OH})_2$	3.33 (1.86×10^{-4} <u>M</u> HNO_3)	$(3 \pm 1) \times 10^{-25}$	(244)

*As quoted in Gel'man et al. ³

C. 6 Pu(IV) Polymer

By far the most important hydrolytic reaction from a radiochemical standpoint is the formation of colloidal aggregates in Pu(IV) solutions by successive hydrolysis reactions. The polymer presumably forms with oxygen or hydroxyl bridges and the reaction is apparently irreversible. $\text{Pu}(\text{OH})_4$ forms when the reaction proceeds to completion. In intermediate stages, however, the colloid remains in solution and has properties markedly different from those of the free ion. In macro concentrations the color of a 0.3 M HNO_3 solution changes from brown to bright green when the solution is heated. The adsorption spectra of polymer has an entirely different character than monomeric Pu(IV) solutions.

The polymer can be formed from many solutions. The formation of Pu(IV) polymer is favored by an increase in the Pu concentration and temperature or by a decrease in the acidity. As the total nitrate concentration increases the polymer precipitates, up to a maximum at 2-3 M NO_3^- .¹⁰⁴ The presence of strong complexing anions inhibit the formation of polymer. Nevertheless, the presence of polymeric Pu should be suspected whenever the acid concentration is below 0.5 M.³²⁷ Polymer is formed when solutions are diluted with water because of the existence of transient regions of high pH, even though the final acidity may be high enough to prevent formation of the polymer.^{327, 64} The polymer is also formed by adding less than a stoichiometric quantity of acid in the dissolution of $\text{Pu}(\text{OH})_4$ precipitate. Fortunately, $\text{Pu}(\text{OH})_4$

can be precipitated from originally monomeric solutions and redissolved without appreciable formation of polymer by using excess reagents.²³⁹ Pu(IV) polymer may be completely precipitated from solution by much less than stoichiometric amounts (approximately 0.15 equivalents of anion) of oxalate, iodate, and phosphate, for example. This phenomenon indicates that the complex contains few charges. This fact was utilized by Ockenden and Welch³⁰⁵ to remove ionic Pu from the colloidal form by means of cation exchange.

Depolymerization is very slow at room temperature in moderate acid concentrations. The rate is increased by heating, stronger acid concentration, and addition of strong complexing agents such as fluoride and sulfate.

Care must be taken to prevent the formation of Pu(IV) polymer in radiochemical separations because of the very different chemical properties of the polymer. The example of non-adsorption on cation exchange resin has already been given. The Pu(IV) polymer does not extract into tri-n-butyl phosphate, (TBP), for example, but does extract into di-n-butyl phosphoric acid, (DBP).⁴⁶ The formation of polymer in solutions of diethylene glycol dibutyl ether (butex) has been observed.⁴⁰⁷

Costanzo and Biggers¹⁰⁴ have determined the rate of polymerization and depolymerization as a function of acidity, temperature, Pu concentration, and salt concentration. Miner²⁷⁸ has summarized information concerning the formation of polymer in nitrate solutions. Both the above references give suggestions for the avoidance of polymer formation in handling and shipping macro amounts of Pu.

Polymeric Pu(IV) adsorbs strongly onto glass, paper, etc., indicating that it is positively charged.⁷⁸ Saturation on glass occurs at approximately $1 \mu\text{g}/\text{cm}^2$. Samartseva³⁴⁵ found that the adsorption is greater on silica than on glass, that 5 to 8 hours was necessary to reach equilibrium with 10^{-8} to 5×10^{-10} M Pu(IV) solutions, and that adsorption on glass was reversible at $\text{pH} < 4$.

The adsorption of Pu(IV)³⁹⁹ and (VI)³⁴⁶ on platinum (Pt) has been studied from aqueous solution. It was found that from 1% to 4% of the Pu(IV) can adsorb on a Pt surface from organic extractants such as TBP, tri-n-octylamine, (TOA), etc.³⁹⁹ Increasing the concentration of the extractant or the aqueous nitric acid phase in equilibrium with the organic phase decreased the adsorption.

C.7 Complex Ion Formation

The formation of complex ions in aqueous solutions with anionic ligands is an important feature of the aqueous chemistry of Pu. Complex formation and hydrolysis are competing reactions and may be looked upon as the displacement of the H_2O molecules in the hydration sphere by the anionic ligand or by OH^- , respectively. The ability of an ion to form complexes is dependent on the magnitude of the ionic potential which may be defined by the equation

$$d = z/r .$$

z is the charge on the ion and r is the ionic radius. The values of the ionic potentials of Pu in different oxidation states are given in Table IV-9.

TABLE IV-9. Ionic Potential of Plutonium in Various Oxidation States *

Cation	Ionic radius (Å)	Charge	Ionic potential
Pu ⁺⁴	0.90	4+	4.44
Pu ⁺³	1.03	3+	2.91
PuO ₂ ⁺²	0.81	2+	2.47
PuO ₂ ⁺	0.87	1+	1.15

* After Gel' man et al.³

The relative tendency of Pu ions to form complexes then is

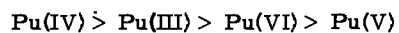

Gel' man et al.³ show that the anionic ligand has some effect on this series. For example, the positions of Pu(III) and Pu(VI) are interchanged in the case of oxalate complexes.

Singly charged anions form weaker complexes with actinides generally than do multiply charged anions. The order of complex forming ability with some anions is

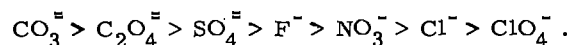

Tables IV-10, IV-11, and IV-12 list available stability constants for complexes of Pu(III), Pu(IV), Pu(V), and Pu(VI), respectively, which are based on the review of Gel' man et al.³ The chemistry of complex compounds and ions of the actinides was also reviewed by Comyns.⁹⁷ Table IV-13 lists stability constants for some complexes of several actinides for comparison.

TABLE IV-10. Stability Constants of Pu(III) Ions*

Complex-formation reaction	Ionic strength	K	Ref.
$\text{Pu}^{+3} + \text{NO}_3^- = \text{PuNO}_3^{+2}$		5.9 ± 0.5	
$\text{Pu}^{+3} + 2\text{NO}_3^- = \text{Pu}(\text{NO}_3)_2^+$		14.3 ± 0.8	
$\text{Pu}^{+3} + 3\text{NO}_3^- = \text{Pu}(\text{NO}_3)_3^0$		14.4 ± 0.8	
$\text{Pu}^{+3} + \text{Cl}^- = \text{PuCl}^{+2}$	0.5	0.58	
	1.0	1.1	
$\text{Pu}^{+3} + \text{SO}_4^{-2} = \text{PuSO}_4^+$		10	
$\text{Pu}^{+3} + 2\text{SO}_4^{-2} = \text{Pu}(\text{SO}_4)_2^-$		50	
		$3.6 \times 10^{11}^{*3}$	
$\text{Pu}^{+3} + 2\text{C}_2\text{O}_4^{-2} = \text{Pu}(\text{C}_2\text{O}_4)_2^-$		2.0×10^9	
		1.4×10^9	
$\text{Pu}^{+3} + 3\text{C}_2\text{O}_4^{-2} = \text{Pu}(\text{C}_2\text{O}_4)_3^{-3}$		2.4×10^9	
		4.5×10^{10}	
$\text{Pu}^{+3} + 4\text{C}_2\text{O}_4^{-2} = \text{Pu}(\text{C}_2\text{O}_4)_4^{-5}$		4.2×10^{11}	
		8.3×10^9	
$\text{Pu}^{+3} + 4\text{HC}_2\text{O}_4^- = \text{Pu}(\text{HC}_2\text{O}_4)_4^-$		$6.3 \times 10^{12}^{*3}$	
	1.0	9.1×10^{10}	
$\text{Pu}^{+3} + \gamma^{-4} = \text{Pu}\gamma^{-4}^{**}$		$1.0 \times 10^{21}^{*3}$	
	1.0	2.3×10^{17}	
	0.1	$(1.3-3.9) \times 10^{18}$	
$\text{Pu}^{+3} + \text{H}\gamma^{-3} = \text{PuH}\gamma^0$		$7.7 \times 10^{11}^{*3}$	
	1.0	1.6×10^9	
$\text{Pu}^{+3} + \frac{1}{2}\text{H}_2\gamma^{-2} = \frac{1}{2}\text{Pu}_2\gamma^{+2} + \text{H}^+$		-	
$\text{Pu}^{+3} + 4\text{C}_6\text{H}_5\text{O}_7^{-3} = \text{Pu}(\text{C}_6\text{H}_5\text{O}_7)_4^{-9}$		1×10^{11}	
$\text{Pu}^{+3} + 6\text{C}_4\text{H}_4\text{O}_6^{-2} = \text{Pu}(\text{C}_4\text{H}_4\text{O}_6)_6^{-9}$		5×10^{15}	
$\text{Pu}^{+3} + 5\text{C}_2\text{H}_3\text{O}_2^- = \text{Pu}(\text{C}_2\text{H}_3\text{O}_2)_5^{-2}$		5×10^{16}	511

*Based on the review of Gel'man et al.,³ The data are taken from this source unless otherwise specified.

** γ^{-4} is the anion of ethylenediaminetetraacetic acid.

*³Values at zero ionic strength.

TABLE IV-11. Stability Constants of Pu(IV) Complexes*

Complex-formation reaction	Ionic strength	K	Ref.
$\text{Pu}^{+4} + \text{Cl}^- = \text{PuCl}^{+3}$	1	1.38	
$\text{Pu}^{+4} + 2\text{Cl}^- = \text{PuCl}_2^{+2}$		0.87	
$\text{Pu}^{+4} + \text{NO}_3^- = \text{Pu}(\text{NO}_3)^{+3}$	2.0	2.9 ± 0.6	
	6.0	4.7	
	1.0	3.48 ± 0.06	
$\text{Pu}(\text{NO}_3)^{+3} + \text{NO}_3^- = \text{Pu}(\text{NO}_3)_2^{+2}$	6.0	0.96	
$\text{Pu}(\text{NO}_3)_2^{+2} + \text{NO}_3^- = \text{Pu}(\text{NO}_3)_3^+$	6.0	0.33	
$\text{Pu}(\text{NO}_3)_3^+ + \text{NO}_3^- = \text{Pu}(\text{NO}_3)_4^0$	-	-	
$\text{Pu}(\text{NO}_3)_4^0 + \text{NO}_3^- = \text{Pu}(\text{NO}_3)_5^-$	-	-	
$\text{Pu}(\text{NO}_3)_5^- + \text{NO}_3^- = \text{Pu}(\text{NO}_3)_6^{-2}$	-	-	
$\text{Pu}^{+4} + \text{HF} = \text{PuF}^{+3} + \text{H}^+$	1	1.7×10^4	
	2	1.1×10^4	
$\text{Pu}^{+4} + 2\text{HF} = \text{PuF}_2^{+2} + 2\text{H}^+$	-	-	
$\text{Pu}^{+4} + 3\text{HF} = \text{PuF}_3^+ + 3\text{H}^+$	-	-	
$\text{Pu}^{+4} + 4\text{HF} = \text{PuF}_4 + 4\text{H}^+$	-	-	
$\text{Pu}^{+4} + \text{SO}_4^{-2} = \text{Pu}(\text{SO}_4)^{+2}$	1.0	4.6×10^3	
$\text{Pu}^{+4} + 2\text{SO}_4^{-2} = \text{Pu}(\text{SO}_4)_2^0$	-	-	
$\text{Pu}^{+4} + 3\text{SO}_4^{-2} = \text{Pu}(\text{SO}_4)_3^{-2}$	-	-	
$\text{Pu}^{+4} + \text{CO}_3^{-2} = \text{Pu}(\text{CO}_3)^{+2}$	10.0	9.1×10^{46}	
$\text{Pu}^{+4} + \text{C}_2\text{O}_4^{-2} = \text{Pu}(\text{C}_2\text{O}_4)^{+2}$		$1.3 \times 10^{11}^{**}$	
	1.0	3.6×10^8	
$\text{Pu}^{+4} + 2\text{C}_2\text{O}_4^{-2} = \text{Pu}(\text{C}_2\text{O}_4)_2^0$		$3.2 \times 10^{20}^{**}$	
	1.0	8.3×10^{16}	
$\text{Pu}^{+4} + 3\text{C}_2\text{O}_4^{-2} = \text{Pu}(\text{C}_2\text{O}_4)_3^{-2}$		$1.0 \times 10^{27}^{**}$	
	1.0	2.5×10^{23}	
$\text{Pu}^{+4} + 4\text{C}_2\text{O}_4^{-2} = \text{Pu}(\text{C}_2\text{O}_4)_4^{-4}$		$6.0 \times 10^{29}^{**}$	
	1.0	3.0×10^{27}	
		3.1×10^{27}	
$\text{Pu}(\text{HPO}_4)_2 + (n + 4 - 3m)\text{H}^+$ $= \text{Pu}(\text{PO}_4)_m \text{H}_n^{n+4-3m} + (2 - m)\text{H}_3\text{PO}_4$ where $m = 1, 2, \dots, 5$ and $n = 0, 1, 2, \dots, 3m$	-	-	
$2\text{Pu}^{+4} + \text{H}_2\text{O}_2 + \text{H}_2\text{O} = \text{Pu}(\text{OO})(\text{OH})\text{Pu}^{+5}$ $+ 3\text{H}^+$ (brown complex)	0.5	8.8×10^6	
$2\text{Pu}^{+4} + 2\text{H}_2\text{O}_2 = \text{Pu}(\text{OO})_2\text{Pu}^{+4} + 4\text{H}^+$ (red complex)	0.5	6.3×10^8	

TABLE IV-11. (Continued)

Complex-formation reaction	Ionic strength	K	Ref.
$\text{Pu}^{+4} + \gamma^{-4**} = \text{Pu}\gamma^0$	0.1	1.58×10^{24} 1.4×10^{26}	
$\text{Pu}^{+4} + \frac{1}{2} \text{H}_2\gamma = \frac{1}{2} \text{Pu}_2\gamma + \text{H}^+$		-	
$\text{Pu}^{+4} + 4\text{C}_6\text{H}_5\text{O}_7^{-3} = \text{Pu}(\text{C}_6\text{H}_5\text{O}_7)_4^{-8}$		1.7×10^{27}	
$\text{Pu}^{+4} + 6\text{C}_4\text{H}_4\text{O}_6^{-2} = \text{Pu}(\text{C}_4\text{H}_4\text{O}_6)_6^{-8}$		2.0×10^{31}	
$\text{Pu}^{+4} + \text{AcAc}^{-*3} = \text{Pu}(\text{AcAc})^{+3}$	0.1	3.16×10^{10}	
$\text{Pu}(\text{AcAc})^{+3} + \text{AcAc}^- = \text{Pu}(\text{AcAc})_2^{+2}$	0.1	1.58×10^9	
$\text{Pu}(\text{AcAc})_2^{+2} + \text{AcAc}^- = \text{Pu}(\text{AcAc})_3^+$	0.1	2.51×10^8	
$\text{Pu}(\text{AcAc})_3^+ + \text{AcAc}^- = \text{Pu}(\text{AcAc})_4^0$	0.1	1.0×10^6	
$\text{Pu}^{+4} + \text{C}_2\text{H}_3\text{O}_2^- = \text{Pu}(\text{C}_2\text{H}_3\text{O}_2)^{+3}$	-	2.0×10^5	359
$\text{Pu}^{+4} + 2\text{C}_2\text{H}_3\text{O}_2^- = \text{Pu}(\text{C}_2\text{H}_3\text{O}_2)_2^{+2}$	-	1×10^9	359
$\text{Pu}^{+4} + 3\text{C}_2\text{H}_3\text{O}_2^- = \text{Pu}(\text{C}_2\text{H}_3\text{O}_2)_3^{+1}$	-	8×10^{13}	359
$\text{Pu}^{+4} + 4\text{C}_2\text{H}_3\text{O}_2^- = \text{Pu}(\text{C}_2\text{H}_3\text{O}_2)_4$	-	2×10^{18}	359
$\text{Pu}^{+4} + 5\text{C}_2\text{H}_3\text{O}_2^- = \text{Pu}(\text{C}_2\text{H}_3\text{O}_2)_5^{+1}$	-	4×10^{22}	359

NOTES:

*Based on the review of Gelman et al.,³ The data are taken from this source unless otherwise specified.

**Values at zero ionic strength.

*3 Abbreviations are:

1. γ^{-4} is the anion of ethylenediaminetetraacetic acid.
2. $\text{AcAc}^- = [\text{CH}_3\text{COCHCOCH}_3]^-$.

TABLE IV-12, Stability Constants of Pu(V) and Pu(VI) complexes*

Complex-formation reaction	Ionic strength	K
$\text{PuO}_2^+ + \text{Cl}^- = \text{PuO}_2\text{Cl}^0$		0.67
$\text{PuO}_2^+ + \text{C}_2\text{O}_4^{2-} = \text{PuO}_2\text{C}_2\text{O}_4^-$	0.05	3.3×10^4
$\text{PuO}_2^+ + 2\text{C}_2\text{O}_4^{2-} = \text{PuO}_2(\text{C}_2\text{O}_4)_2^{-3}$	0.05	2.4×10^7
$\text{PuO}_2^+ + \gamma^{-4} = \text{PuO}_2\gamma^{-4**}$		$7.9 \times 10^{10*3}$
$\text{PuO}_2^{+2} + \text{NO}_3^- = \text{PuO}_2\text{NO}_3^+$	0.05	1.5×10^{10}
$\text{PuO}_2\text{NO}_3^+ + \text{NO}_3^- = \text{PuO}_2(\text{NO}_3)_2^0$		72
$\text{PuO}_2^{+2} + \text{NO}_3^- = \text{PuO}_2(\text{NO}_3)^0$		36 ± 0.3
$\text{PuO}_2^{+2} + \text{Cl}^- = \text{PuO}_2\text{Cl}^+$	1.0	1.25
$\text{PuO}_2^{+2} + 2\text{Cl}^- = \text{PuO}_2\text{Cl}_2^0$		0.73 ± 0.07
$\text{PuO}_2^{+2} + \gamma^{-4} = \text{PuO}_2\gamma^{-2}$		0.35
$\text{PuO}_2^{+2} + \text{C}_2\text{O}_4^{2-} = \text{PuO}_2\text{C}_2\text{O}_4^0$	1.0	1.75×10^{16}
$\text{PuO}_2^{+2} + 2\text{C}_2\text{O}_4^{2-} = \text{PuO}_2(\text{C}_2\text{O}_4)_2^0$		$6.9 \times 10^{7*3}$
$\text{PuO}_2^{+2} + \text{CH}_3\text{COO}^- = \text{PuO}_2(\text{CH}_3\text{COO})^+$		4.3×10^6
$\text{PuO}_2^{+2} + 2\text{CH}_3\text{COO}^- = \text{PuO}_2(\text{CH}_3\text{COO})_2^0$	1.0	$5.0 \times 10^{12*3}$
$\text{PuO}_2^{+2} + 3\text{CH}_3\text{COO}^- = \text{PuO}_2(\text{CH}_3\text{COO})_3^-$		3.0×10^{11}
$\text{PuO}_2^{+2} + 2\text{CO}_3^{2-} = \text{PuO}_2(\text{CO}_3)_2^{-2}$		1.9×10^3
		2.0×10^6
		2.3×10^7
		$1 \times 10^{15*3}$

* Taken from the review of Gel'man et al.³

** γ^{-4} is the anion of ethylenediaminetetraacetic acid.

*³ Values at zero ionic strength.

TABLE IV-13. Stability Constants of Complexes of Several Actinides*

Complex-formation reaction	U	Np	Pu	Am
$\text{Me}^{+3} + 2\text{C}_2\text{O}_4^{-2} = \text{Me}(\text{C}_2\text{O}_4)_2^-$	-	-	11.55 ^{*3}	11.46 ^{*3}
$\text{Me}^{+3} + \gamma^{-4} = \text{Me}\gamma^{-4**}$	-	-	21.0 ^{*3}	20.6 ^{*3}
$\text{Me}^{+4} + \text{C}_2\text{O}_4^{-2} = \text{Me}(\text{C}_2\text{O}_4)^{+2}$	8.61	8.54	8.74	-
$\text{Me}^{+4} + 2\text{C}_2\text{O}_4^{-2} = \text{Me}(\text{C}_2\text{O}_4)_2^0$	16.9	17.54	16.9	-
$\text{Me}^{+4} + 3\text{C}_2\text{O}_4^{-2} = \text{Me}(\text{C}_2\text{O}_4)_3^{-2}$	22.7	24.0	23.4	-
$\text{Me}^{+4} + 4\text{C}_2\text{O}_4^{-2} = \text{Me}(\text{C}_2\text{O}_4)_4^{-4}$	27.7	27.4	27.5	-
$\text{MeO}_2^+ + \text{C}_2\text{O}_4^{-2} = \text{MeO}_2(\text{C}_2\text{O}_4)^-$	-	5.04	4.52	-
$\text{MeO}_2^+ + 2\text{C}_2\text{O}_4^{-2} = \text{MeO}_2(\text{C}_2\text{O}_4)_2^{-3}$	-	7.36	7.38	-
$\text{MeO}_2^{+2} + \text{CH}_3\text{COO}^- = \text{MeO}_2(\text{CH}_3\text{COO})^+$	2.7	3.31	3.27	-
$\text{MeO}_2^{+2} + 2\text{CH}_3\text{COO}^- = \text{MeO}_2(\text{CH}_3\text{COO})_2^0$	5.10	5.83	6.29	-
$\text{MeO}_2^{+2} + 3\text{CH}_3\text{COO}^- = \text{MeO}_2(\text{CH}_3\text{COO})_3^-$	6.41	7.90	7.36	-
$\text{MeO}_2^{+2} + \text{C}_2\text{O}_4^{-2} = \text{MeO}_2\text{C}_2\text{O}_4^0$	6.77	-	6.64	-
$\text{MeO}_2^{+2} + 2\text{C}_2\text{O}_4^{-2} = \text{MeO}_2(\text{C}_2\text{O}_4)_2^{-2}$	12.0	-	11.5	-
$\text{MeO}_2^{+2} + 2\text{CO}_3^{-2} = \text{MeO}_2(\text{CO}_3)_2^{-2}$	14.0	-	15.0	-

*Taken from the review by Gell'man et al.³

** γ^{-4} is the anion of ethylenediaminetetraacetic acid.

*3 Thermodynamic values calculated by A. I. Moskvina.

D. Separation Methods

D.1 Co-precipitation and Precipitation

Co-precipitation and precipitation present different problems to the radiochemist because, in general, the insoluble compounds of Pu which have desirable properties in precipitation reactions are not those formed in co-precipitation reactions. Of the common reactions, only precipitation of PuF_3 and PuF_4 and co-precipitation of Pu(III) and Pu(IV) by LaF_3 are analogous. Since the radiochemist is likely to have small or trace quantities of Pu in a relatively large volume, co-precipitation reactions are more important to him, and will be considered first.

Co-precipitation

Co-precipitation reactions are extremely important in the radiochemistry of Pu. Indeed, the first separation and isolation of the element was accomplished by co-precipitation with LaF_3 . This method has become the "classic" radiochemical method for Pu and is still widely used.

The co-precipitation behavior of Np and Pu toward a number of precipitants is shown in Table IV-14, taken from the review of Hyde.¹⁶ The behavior of these elements is representative of the actinides in a given oxidation state. The possibility of separation arises when the elements can be maintained in separate oxidation states, and a selective precipitant is used. The review of Bonner and Kahn⁴⁹ gives a thorough discussion of the mechanism of co-precipitation and a good review of co-precipitation data for all the elements through 1949. The co-precipitation behavior of Pu has been discussed by Leader.²⁵³

The separation of Pu by co-precipitation usually takes advantage of the aforementioned oxidation and reduction cycles to effect purification. The procedure may be illustrated with the carrying of Pu(III) and Pu(IV) and the non-carrying of Pu(VI) on LaF_3 . Only those elements with co-precipitation and oxidation-reduction behavior very similar to that of Pu interfere. The oxidation-reduction cycle may be repeated as many times as needed to get any desired degree of purity. The use of LaF_3 precipitation is also a valuable group separation and volume reduction step, since not very many elements have acid-insoluble fluorides.

In many radiochemical procedures, LaF_3 is mounted for alpha counting to determine the Pu.^{191, 83, 82, 446} Chenley *et al.*⁸³ report a 2.6% negative bias by this method because of absorption of the alpha particles in the LaF_3 . This bias is a function of the thickness of the counting sample and must be determined for each procedure.

Calcium is one of the elements which interferes with LaF_3 co-precipitation, since the fluoride is moderately insoluble. One method of solving the problem of high Ca concentrations (>200 mg/l) is reported by Scheidhauer and Messainguiral.³⁵¹ The Pu is oxidized to Pu(VI) and CaF_2 is precipitated away from the Pu. Following reduction, the Pu can either be co-precipitated or separated by other means.

TABLE IV-14. Co-precipitation Behavior of Trace Amounts of Plutonium and Neptunium in Principal Valence States.¹⁶

Carrier compound	Pu(III)	Pu(IV)	Pu(VI)	Np(IV)	Np(V)	Np(VI)
Hydroxides	C*	C	C	C	C	C
Lanthanum fluoride	C	C	NC**	C	C	NC
Phosphates:						
Zirconium phosphate	NC	C	NC	C		NC
Thorium pyrophosphate	NC	C	NC			
Thorium hypophosphate		C	NC			
U(IV) hypophosphate		C	NC			
Oxalates:						
Thorium oxalate	C	C	NC	C		
U(IV) oxalate	C	C	NC			
Bismuth oxalate	C	C	NC			
Lanthanum oxalate	C	C	NC	NC		
Iodates:						
Zirconium iodate		C	NC			
Thorium iodate		C	NC	C		NC
Ceric iodate		C	NC			
Sodium uranyl acetate	NC	NC	C	NC	Poor* ³	C
Zirconium phenylarsonate	NC	C	NC	C	Poor	NC
Thorium peroxide		C		C		
Bismuth arsonate		C	NC			

*The letter "C" indicates that the co-precipitation has been observed to be nearly quantitative under proper conditions.

**The letters "NC" mean that co-precipitation may be made less than 1 to 2 percent under proper conditions.

*³"Poor" indicates an intermediate percentage of carrying.

Co-precipitation of Pu with LaF₃ is a common step in the analysis of biological material for Pu.^{360, 349, 257, 125, 208, 53}

Bismuth phosphate. The carrying of Pu on BiPO₄ is another of the early, widely used methods of separating Pu from U and fission products. The development of the process is reported by Thompson and Seaborg.⁴⁰¹ Like LaF₃, BiPO₄ carries both Pu(III) and Pu(IV) when precipitated from moderately concentrated nitric acid. A peculiarity is the fact that Pu(IV) is more efficiently carried than Pu(III). The optimum conditions for the co-precipitation of Pu have been reported by Adamson.²⁰ These are: 1) co-precipitation at the minimum BiPO₄ solubility, 2) the absence of strong complexing agents, 3) slow precipitation, and 4) minimum digestion after precipitation is complete.

In addition to being very successful in the large scale processing Pu, BiPO₄ precipitations have been used in general radiochemical procedures^{341, 415} to concentrate Pu from large volumes of water²³⁷ and to determine Pu in urine.¹²⁶ The procedure of Rydberg³⁴¹ uses the familiar oxidation-reduction cycle to effect purification. Plutonium

is first oxidized to Pu(VI) with sodium bismuthate, BiPO_4 precipitated from 0.1 N HNO_3 , then reduced with ferrous ion, and finally precipitated with BiPO_4 .

Zirconium phosphate. Zirconium phosphate is a specific co-precipitant for Pu(IV), in contrast to BiPO_4 and LaF_3 , which carry both Pu(III) and Pu(IV). Hyde¹⁶ describes a Np-Pu separation based on the reduction to Pu(III) before precipitating zirconium phosphate.

Other inorganic co-precipitants. Dupetit and Aten¹¹⁸ described the co-precipitation of actinides with thorium peroxide and uranium peroxide. All the elements were in the tetravalent oxidation state. They found, that in general, the crystal type made little difference in the co-precipitation of these elements. For example, Pu carried equally well with thorium peroxide, which has a similar crystal structure to plutonium peroxide, and with uranium peroxide which has a different structure.

A mixture of Pu(III) and Pu(IV) has been carried on lanthanum iodate from dilute HCl solution.²⁹³

Plutonium can be separated directly from a urine sample by co-precipitation with calcium ammonium phosphate.^{102, 74}

Pu(IV) and Am(III) have been quantitatively co-precipitated with $\text{K}_5\text{La}(\text{SO}_4)_4$.¹⁵¹ Pu(IV) and Np(IV) have been separated by precipitation of the Pu from solutions which are unsaturated in K_2SO_4 . The minimum Pu solubility in this system occurs at 0.7 M.¹⁵²

Organic co-precipitants. Zirconium phenylarsonate is a specific carrier for Pu(IV) and has been used in analytical procedures to determine the oxidation state,^{193, 414, 227} and to separate Np and Pu after reduction with NH_2OH .³⁹² King²²⁷ used 2×10^{-4} N NH_2OH to prevent the reduction of Pu(IV) during the analysis, while at the same time not oxidizing the Pu(III). Voigt *et al.*⁴¹⁴ found that the precipitation of Pu is nearly quantitative from a formate buffer of pH approximately 2, and slightly less so from HCl solutions. Ice¹⁹³ got quantitative recovery in precipitations from 1 M HCl solutions.

Merz²⁷³ used mandelic acid and p-bromomandelic acid with Y(III) to carry Pu(III) quantitatively at pH 2-4 and above. Zirconium was used for Pu(IV) at higher acidities. The precipitation was about 85% complete at 1 M HCl and HNO_3 for p-bromomandelic acid, and somewhat lower than this for mandelic acid.

Weiss and Shipman⁴²² quantitatively recovered Fe, Pu, Ce, and Pr from solution by the formation of oxine homogeneously in solution by the hydrolysis of 8-acetoxyquinoline.

These workers determined Pu in urine by co-crystallization with potassium rhodizonate.^{421, 374} Kuznetsov and Akimova²⁴⁷ co-precipitated Pu(IV) from 3 M HNO_3 solutions with butyl rhodamine. The method is quantitative and separates from all elements except Th(IV) and U(VI). Repeated precipitations effect the separation. Other dyes were successfully used to separate Pu by the same procedure.

Precipitation

Precipitation of macro quantities of Pu is necessary in many analytical and radiochemical procedures. The precipitation reactions which have been found useful in practice will be reviewed in this section. The use of various precipitates as purification steps for Pu is illustrated by Table IV-15, which gives decontamination factors for Pu from Fe, Co, Zr, Mo, Ru, and Ce.⁴³¹ As usual, Zr and Ru give the most trouble.

TABLE IV-15. Decontamination Factors for Plutonium by Precipitation Methods.⁴³¹

Element	Plutonium peroxide	Plutonium (III) oxalate	Plutonium (IV) oxalate	Plutonium (III) fluoride
Fe	50	33	10	1.4
Co	30	47	> 95	8.6
Zr	1	3.5	> 44	1.1
Mo	>140	> 13	> 15	1.1
Ru	>14	> 38	33	36
Ce	6	1	1	1.1

Hydroxide. Both Pu(III) and Pu(IV) may be precipitated from mineral acid solution by sodium, potassium or ammonium hydroxide as hydrated hydroxides or hydrous oxides. Care must be taken in redissolving Pu(IV) hydroxide in acid to prevent formation of Pu(IV) polymer, by maintaining a high acid concentration during the dissolution. Once formed, the polymer dissolves very slowly in acid solutions. This subject is treated more fully in the section on polymeric Pu(IV).

Fluoride. PuF₃ and PuF₄ may be precipitated from acid solution by addition of excess HF. Prevot *et al.*³²⁵ found that PuF₃ forms a more tractable, crystalline precipitate than does PuF₄. The compound is stable to oxidation if the precipitate is kept slurried in the supernatant solution.³²³ The freshly precipitated compounds dissolve readily in reagents which complex fluoride ion, such as H₃BO₃, but if heated to 500° dissolve only with difficulty. Metathesis to the hydroxide with sodium or potassium hydroxide is another method of solution. Jones²¹⁴ found that PuF₃ was suitable for use as a gravimetric standard for Pu, at least for a period of several months. This method has not been widely used, however. It is interesting to note that PuO₂ prepared by ignition of this PuF₃ at 500°C in oxygen was readily soluble in nitric acid, in contrast to the findings of other workers. This solubility is attributed to the extremely fine particle size of PuO₂ prepared in this work.

Peroxides. Pu(IV) peroxide is formed when hydrogen peroxide is added to acid solutions of Pu(III), Pu(IV), Pu(V), and Pu(VI), because H₂O₂ can act as both an oxidant and a reductant. Pu(IV) peroxide always incorporates some of the anion present into the crystalline precipitate. It has been suggested⁷ that the presence of the anion is due to a more or less random placement between sheets of Pu and peroxide

oxygen in the ratio 1:3. If an excess of peroxide is used in the precipitation, the ratio may be lower. The extra peroxide also serves to hold the sheets together.

Precipitation of plutonium peroxide has been used as a purification step for Pu from most other cations^{72, 158, 329, 425} and as a step in the preparation of high purity Pu compounds and solutions.³²⁹ This precipitation has been used to separate Pu from Am, the Am remaining in the supernatant solution,⁷² and to separate Pu and U.²⁷⁷ In the latter procedure the Pu was oxidized to Pu(VI) by potassium bromate which served as a holding oxidant, and uranyl peroxide precipitated. Separation factors of 2-4 were obtained.

Oxalates. Precipitation of plutonium oxalate from dilute acidic solution has been used as a concentration step before conversion to oxide or metal.²⁶⁵ The separation factors from other elements are not so great in some cases as in the peroxide precipitation procedure^{431, 141} (Table IV-14), but the precipitate is easy to filter and work with. These compounds undergo decomposition by the action of their own alpha radioactivity.^{134, 389, 216} The oxalate is decomposed into carbonate and CO, and the CO may reduce either Pu(VI) or Pu(IV).

Other compounds. The precipitation of plutonium (IV) sulfate tetrahydrate has been used to prepare a high purity Pu compound for use as a gravimetric standard for Pu.⁴²⁴ Starting with a grossly impure solution, a product of 99.98% purity was obtained after five successive recrystallizations. This compound is suitably stable as a gravimetric standard at least for 18-months.⁴⁴⁸

Dicesium plutonium (IV) hexachloride has also been proposed as a primary gravimetric standard.²⁷⁹ The compound can be prepared by precipitation from an 8 M HCl solution of Pu(IV) by addition of CsCl in HCl.

D.2 Solvent Extraction Methods

The large-scale processing of reactor targets is largely done by liquid-liquid extraction. This is so because of a combination of desirable properties of this method; for example, great specificity for U and Pu, easy adaptability to remote handling facilities, etc. These advantages are easily carried over to laboratory separations where specificity and ease of handling are equally important.

A very great deal of research on liquid-liquid extraction systems for Pu has been carried out in the development of large-scale processes, and a large portion of the solvent extraction data reported in this section was taken under the spur of the seemingly never-ending quest for more specific extractants, better radiation stability, and the like. The basic data on the extractive properties of a given solvent are, of course, equally applicable in the laboratory or industrial situation.

The general principles of solvent extraction have been put forth in the book by Morrison and Freiser,²⁹² and in a comprehensive review by Marcus.²⁶⁷ The solvent extraction data for Pu have been thoroughly reviewed by Smith.³⁸⁸ Carleson⁷⁷ has written a good general survey of the processing chemistry of nuclear fuel for Pu, while a recent symposium⁴⁵⁰ contained much of interest concerning the newer extraction systems.

In this section the data will most often be given in terms of the distribution coefficient D , which is defined by the equation

$$D = \frac{\text{concentration of the solute in the organic phase}}{\text{concentration of the solute in the aqueous phase}}$$

To save space, the notation " D_x " for "the distribution coefficient of species x " will be used in the text.

Organo Phosphorous Compounds

This large and important class of extractants includes the neutral and acidic esters of ortho phosphoric acid and related compounds, the phosphonates, phosphinates and phosphine oxides. The class divides naturally into neutral and acidic compounds by the differences in extraction mechanism. The neutral compounds extract by solvation of a neutral complex in the organic phase by the phosphoryl oxygen, while the acidic compounds, in general, operate by an ion-exchange reaction to form an extractable species. Further solvation may occur in the organic phase in some extraction systems of this type.

Neutral Compounds

Tri-*n*-butylphosphate (TBP), $(C_4H_9O)_3PO$, will serve as the typical compound of this type. A complete survey of the literature on TBP extraction of Pu is beyond the scope of this review. The more recent papers will be emphasized, although earlier project work will necessarily be included. A summary of early work on TBP has been given by Geary.¹⁴³ The physical and chemical properties of TBP as an extracting agent have been summarized by McKay and Healy.²⁵⁹ The TBP-nitrate system will be discussed first, followed by other aqueous systems, and finally other neutral organo-phosphorous compounds.

TBP-nitrate systems. Hesford and McKay¹⁷⁸ have formulated the extraction reaction of metal nitrates into TBP as

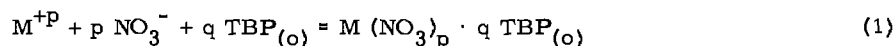

where p is the charge on the metal ion and q is the number of TBP molecules solvating the nitrate molecule in the organic phase. The subscript (o) refers to species in the organic phase, and species without subscripts are in the aqueous phase. The equilibrium constant, neglecting activity coefficients, is then

$$K_1 = \frac{[M(NO_3)_p \cdot q TBP_{(o)}]}{[M^{+p}] [NO_3^-]^p [TBP_{(o)}]^q} \quad (2)$$

and the distribution coefficient

$$D = K_1 [NO_3^-]^p [TBP_{(o)}]^q. \quad (3)$$

Under constant aqueous conditions, and at a sufficient dilution of TBP in an inert diluent to make Eq. (2) valid, the distribution will be proportional to the q th power of

the TBP concentration. Solovkin³⁹¹ has calculated distribution coefficients for this system on a semi-empirical basis and obtained good agreement with experimental data.

Tetra- and hexavalent Pu as well as other actinides have been shown to be disolvates in the organic phase.⁴⁴ The extracted complexes are then $\text{Pu}(\text{NO}_3)_4 \cdot 2 \text{TBP}$ for Pu(IV) and $\text{PuO}_2(\text{NO}_3)_2 \cdot 2 \text{TBP}$ for Pu(VI). Work with trivalent Pu has shown that the extracted complex is tri-solvated, $\text{Pu}(\text{NO}_3)_3 \cdot 3 \text{TBP}$.³⁷² Laxminarayanan *et al.*²⁵² have shown that Pu(IV) in 2-4 M HNO_3 is associated with an average of 2.6 nitrate ions and does not exist as undissociated $\text{Pu}(\text{NO}_3)_4$ by combining solvent extraction data from several solvents. There is direct evidence that the complexes are un-ionized in the organic phase.¹⁷⁰

Typical data for the extraction of a number of elements at trace concentration into 19 volume % TBP in kerosene from nitric acid solution of various concentrations are shown in Fig. 1. The distribution coefficients rises steeply at low nitric acid concentrations because of the strong salting-out effect of the nitrate ion (Eq. 1), passes through a maximum, and then falls at higher acid concentrations. Some elements (e. g. Th and Y) pass through minima and rise again.

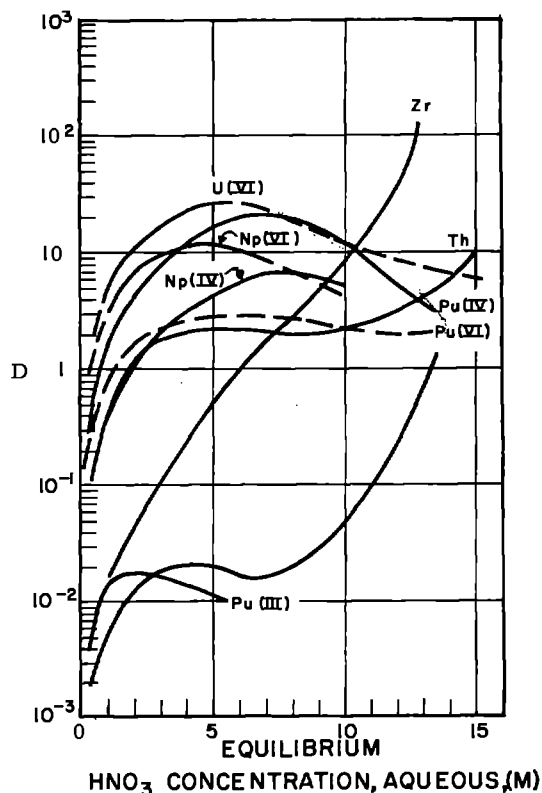

Fig. 1. Extraction of nitrates at trace concentration into 19 volume % TBP in kerosene at 25°C from nitric acid solutions. Taken from McKay and Healy.²⁵⁹ The individual references are: yttrium³⁵⁰; thorium¹⁷⁹; zirconium²⁵; uranium and neptunium²⁶; and plutonium^{44, 258}.

Several other studies of the extraction of Pu from nitric acid solutions have been reported. Carleson⁷⁶ used 40% TBP in kerosene and paid particular attention to requirements to maintain Pu in the desired oxidation state. He found that NaNO_3 was necessary to prepare pure Pu(IV) from an equilibrium disproportionated mixture. Figure 2 shows the effect of HNO_3 concentration on several reducing agents in the extraction of an equilibrium Pu solution, and the extraction curve for Pu(III) alone. Ferrous sulfamate with added hydroxylamine effects complete reduction of Pu(IV) to Pu(III) at up to 2 M HNO_3 , but fails at higher acidities. Ferrous ion plus hydrazine and hydroxylamine fail to complete the reduction at progressively lower acidities. Carleson also found that solid KBrO_3 did not oxidize Pu(IV) to Pu(VI) in 1.55 M HNO_3 at room temperature, but that the oxidation was quantitative in 0.1 M BrO_3^- after heating to 95°C for several hours.

Codding *et al.*^{92, 93} used 30% TBP in kerosene, Rozen and Moiseenko³³⁴

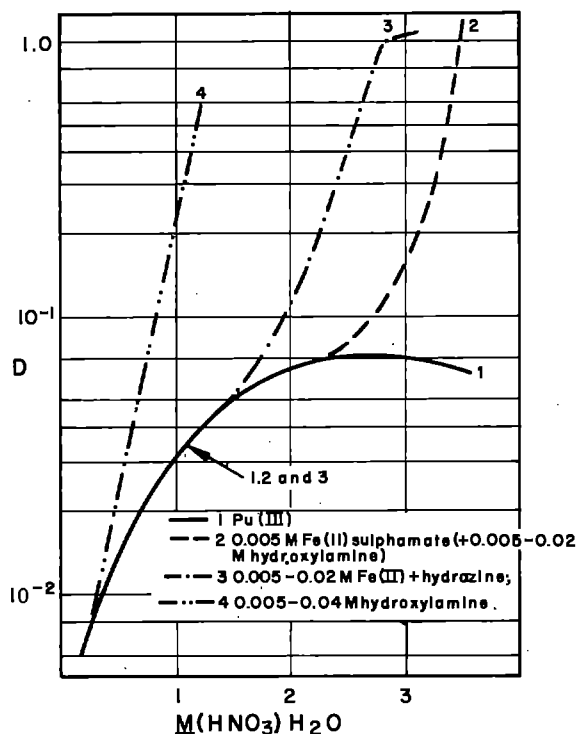

Fig. 2. Distribution of Pu(III) and equilibrium Pu(III), Pu(IV), and Pu(VI), mixtures in the presences of several reducing agents in 40% TBP in kerosene and nitric acid; after Carlsson.⁷⁶

with atomic number, i. e., Th(IV) < Np(IV) < Pu(IV), while that of the hexavalent actinides decreases with atomic number, i. e., Pu(VI) < Np(VI) < U(VI).⁴⁴

Moiseenko and Rozen²⁸¹ measured the effect of temperature on the extraction of Pu(IV) as a function of nitric acid concentration and uranyl nitrate concentration (Figs. 3, 4, and 5). In the absence of uranyl nitrate the distribution coefficient decreases with temperature below 5 M HNO₃, while at higher acidities it increases. This effect is explained by a decrease in the equilibrium constant for the distribution reaction with temperature, with a compensating increase in the activity coefficient of Pu(IV) at higher acidities. This increase is ascribed to a decreased association of Pu(IV) with nitrate ions at higher temperatures. Shevchenko and Federov³⁶⁴ have studied the same system at nitric acid concentrations below 4 M with similar results.

Best et al.⁴³ measured the distribution of several tripositive actinides and lanthanides from nitric acid solutions into 100% TBP. Some of their data are shown in Fig. 6 plotted as a function of atomic number, along with the lanthanide data of Hesford et al.¹⁷⁷ for comparison. The curves for the two homologous series are approximately superimposable if adjustment is made to compare ions of the same radius. This illustrates the importance of ionic radius on the chemical behavior of these elements.

and Shevchenko and Federov³⁶⁴ used 20% TBP in kerosene, and Bernstrom and Rydberg⁴¹ used 100% TBP. All the above workers measured the distribution coefficients of Pu(IV) and Pu(VI) as a function of equilibrium aqueous nitric acid concentration with similar results, and several also studied the effect of U(VI) competition on the extraction of Pu(IV) and Pu(VI). Flanary¹³² derived equilibrium constants (defined by Eq. (2)) for U(VI), HNO₃, and Pu(IV) of 22, 0.18, and 3 respectively, while Rozen and Moiseenko³³⁴ and Coddling et al.^{92, 93} get about 1.5 for Pu(IV). These values illustrate the effective competition of macro U(VI) over trace Pu(IV) in the simultaneous extraction of these species, resulting in a large reduction of the Pu distribution coefficients (see Fig. 5).

The order of extractability into TBP from nitric acid solutions for the actinides is M(IV) > M(VI) >> M(III).^{44, 258, 26} The extractability of the tetravalent actinides increases

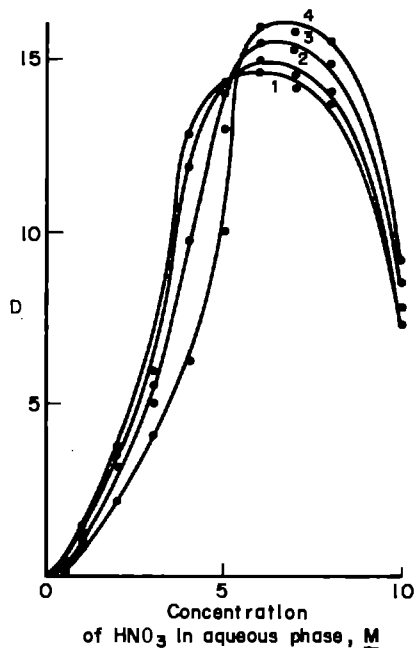

Fig. 3. Dependence of distribution coefficient of Pu(IV) into TBP on concentration of nitric acid in aqueous phase (for solutions not containing uranyl nitrate).²⁸¹ Curve 1-20°, curve 2-30°, curve 3-50°, and curve 4-70°.

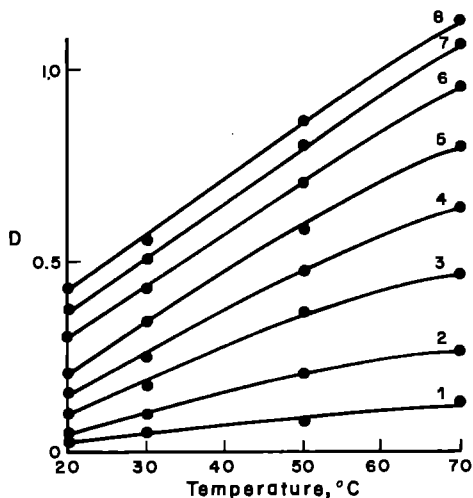

Fig. 5. Dependence of distribution coefficient of Pu(IV) into TBP on temperature with a uranyl content of 0.42 M in the aqueous phase.²⁸¹ Concentration of HNO₃: curve 1-0.5N, curve 2-1N, curve 3-2N, curve 4-3N, curve 5-4N, curve 6-6N, curve 7-8N, and curve 8-10N.

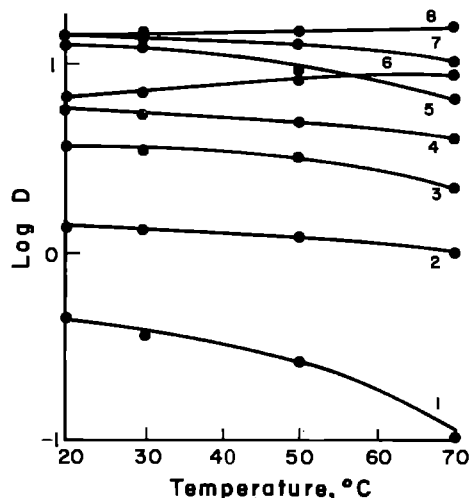

Fig. 4. Dependence of distribution coefficient of Pu(IV) into TBP on temperature in solutions not containing uranium.²⁸¹ Concentration of HNO₃: curve 1-0.5N, curve 2-1N, curve 3-2N, curve 4-3N, curve 5-4N, curve 6-10N, curve 7-5N, and curve 8-6 to 8N.

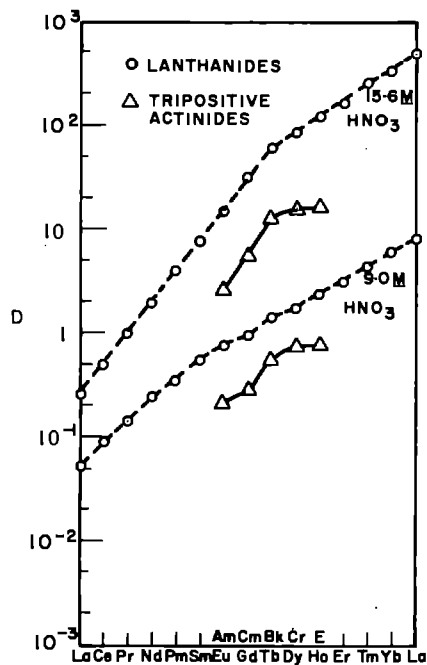

Fig. 6. Distribution coefficient as a function of position in the lanthanide and actinide series.^{43, 177}

○ Lanthanides
 △ Tripositive actinides

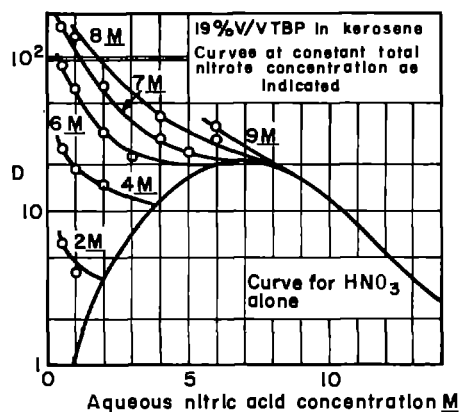

Fig. 7. Effect of NaNO_3 on the distribution of Pu(IV) between 19% TBP in kerosene and nitric acid solutions.^{44, 258}

The salting-out effect of non-extractable salts on the extraction of Pu and U has received considerable attention.^{165, 43, 149, 52} Typical results are shown in Fig. 7 in which $\text{Na}(\text{NO}_3)$ is used as the salting agent for Pu(IV).^{44, 258} At a constant total nitrate concentration the distribution coefficient decreases as the proportion of nitric acid is increased, but the distribution coefficient is always greater than that of pure HNO_3 . This effect is caused by the reduction of competition for TBP molecules by the lowering of the extractable nitric acid concentration.

Aluminum nitrate has been used as a salting-out agent for Pu in several TBP extraction processes.^{149, 165, 52, 354}

Applications of TBP-nitrate systems. Many papers have been written about the application of TBP to the processing of irradiated U for Pu.^{195, 132, 93, 148, 325, 114, 202, 365, 109, 133} The process involves extracting Pu(IV) and U(VI) away from fission products into TBP-kerosene from nitric acid solutions, stripping the Pu into a relatively concentrated nitric acid solution by reduction to Pu(III), and finally stripping the U(VI) with water. Nitrous acid is added to the feed solution in the first extraction to stabilize Pu(IV).⁷⁶ Ferrous sulfamate was first used as a reductant in the Pu stripping stage.^{335, 195, 132} although U(IV) as a reductant has been extensively studied.^{209, 221, 67, 385, 353, 342, 38} This reagent can be generated from U(VI) and stabilized by volatile reductants, with the considerable advantage in large-scale processing plants of not introducing non-volatile materials (e. g. iron) into the waste streams, thus permitting a smaller waste volume. The behavior of fission products and other elements in this process has received much attention, both in the primary papers and others.^{88, 161, 431, 133, 367} A variant has been described in which the fission products, Pu and U, are successively stripped from the TBP phase by stepwise lowering of the acid concentration.²⁰³

TBP was used in the isolation of naturally occurring Pu.³¹⁵

Analytical³⁶² and radiochemical^{144, 114} procedures for Pu based on TBP extraction from HNO_3 have been given.

An interesting application is the use of TBP in reversed-phase chromatography for various heavy element separations,^{124, 156, 157, 190} and for the separation of Pu(III), Pu(IV) and Pu(VI) in HNO_3 .³⁸⁰

TBP - other aqueous systems. Tetra- and hexavalent actinides extract well into TBP from moderately concentrated HCl solutions, while trivalent species are

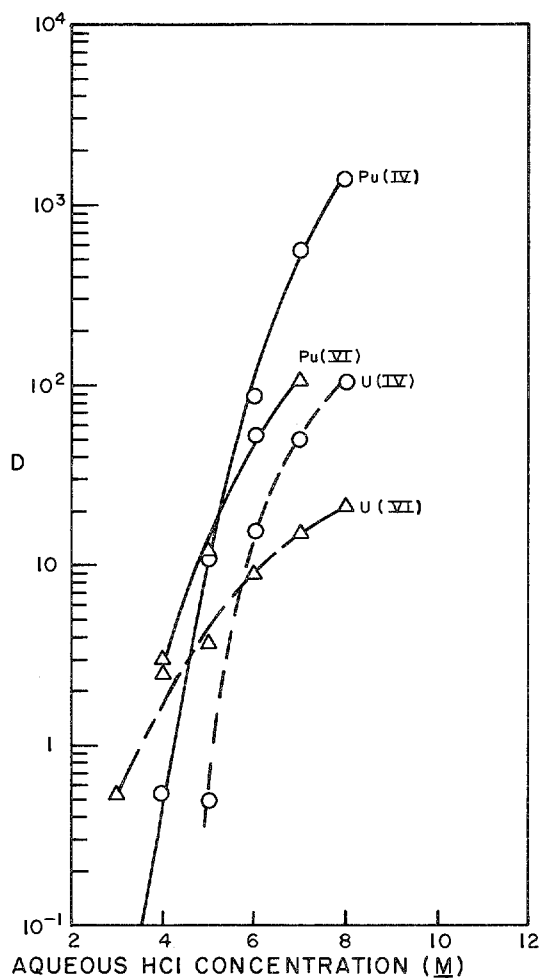

Fig. 8. Extraction of U and Pu by 30% TBP in CCl_4 from HCl solutions.²⁴⁹

into TBP from trichloro- and trifluoroacetic acids.¹⁸³ The distribution coefficients decrease with increasing acidity, rather than the usual increase. The distribution coefficients for both Pu(IV) and Pu(VI) are about 4 to 5 times as great for CCl_3COOH as for CF_3COOH at low acid concentrations. For extraction of Pu(IV) into 30% TBP in Amsco-125 (a kerosene type diluent) from an initial concentration of 0.5 M CCl_3COOH , $D = 21$; for Pu(VI), $D = 4$.

The effect of addition of sulfuric acid and phosphoric acid to Pu(IV) or Pu(VI) – nitric acid – TBP systems is invariably to lower the distribution coefficient^{438, 440, 437} – sulfuric⁴³⁹ – phosphoric. This effect is presumably due to the formation of unextractable sulfate and phosphate complexes of Pu. The effect is more pronounced in Pu(IV) than in Pu(VI), and at lower nitric acid concentrations. For example, making the aqueous phase 0.08 M in H_2SO_4 lowered D for Pu(IV) from 16 to 9.5 in 4 M HNO_3 ; in 2 M HNO_3 the corresponding decrease was from 9 to 1.4.⁴³⁷ On the other hand the lowering of D for

essentially unextractable. Larsen and Seils²⁴⁹ measured the extraction of U and Pu into 30% TBP in CCl_4 (Fig. 8), and used this system as the basis of an analytical procedure for these elements (Procedure 15, Sect. VIII). Both Pu(IV) and Pu(VI) extract better at all acidities than U(IV) and U(VI). The quadrivalent actinides have higher distribution coefficients than the hexavalent above 5-6 M HCl, while the reverse is true at lower acidities. These authors report a distribution coefficient of about 10^{-3} for Pu(III) and 10^{-4} for Am(III) in 8 M HCl under the same conditions. The value for Am is considered more reliable because of possible partial oxidation of the Pu(III) to Pu(IV). HCl is much less extractable than HNO_3 into TBP. Larsen and Seils report $D = 0.01$ at 6 M HCl and 0.12 at 8 M HCl into 30% TBP in CCl_4 .²⁴⁹

Solovkin *et al.*³⁹⁰ found that the extraction of Pu(IV) into 1.1 M (30%) TBP in CCl_4 from perchloric acid was appreciable. The distribution coefficients varied from 0.0045 at 0.4 M HClO_4 to 0.9 at 6.4 M HClO_4 . The extracted complex was determined to be di-solvated by TBP dilution experiments.

Pu(IV) and Pu(VI) extract well

Pu(VI) by the addition of enough H_2SO_4 to 2 M HNO_3 to make the solution 0.1 M in H_2SO_4 was only from 2.6 to 2.2.

Sulfuric acid also decreases the extraction of Pu(IV) into TBP from HCl solutions.⁴⁴¹ A solution 1 M in H_2SO_4 lowered D_{Pu} approximately a factor of 10 throughout a change in HCl concentration of 3-8 M.

Other neutral phosphorous compounds. A wide variety of organo-phosphorous compounds has been studied in an attempt to find other extractants for Pu and U. Higgins *et al.*¹⁸¹ working with the butyl series found the order to be phosphate $((\text{RO})_3\text{PO}) < \text{phosphonate } (\text{R}(\text{RO})_2\text{PO}) < \text{phosphinate } (\text{R}_2(\text{RO})\text{PO}) < \text{phosphine oxide } (\text{R}_3\text{PO})$. Thus the extracting power increases with the number of C-P bonds. Burger^{69, 70} confirmed this series and correlated the extracting power with the basicity of the phosphoryl oxygen as measured by the P-O stretching frequency. Burger,^{69, 70} and Petrov *et al.*³¹⁸ found that electronegative substituents in the alkyl chain such as Cl and phenyl strongly depressed the extraction. Siddall³⁷⁶ found that increasing the length of the alkyl chain in the phosphate series made little difference up to 8 carbon atoms for quadrivalent and hexavalent actinides. The effect of branching the alkyl chain is to increase the extraction of U, Np, and Pu, but to strongly depress that of Th. This effect is attributed to steric effects and possible tri-solvation of the Th complex at high extractant concentrations.

The extraction mechanism of these compounds is generally the same as that for TBP, but not necessarily with the same solvation number for all elements.²⁶⁷ Tri-n-octylphosphine oxide (TOPO) and tri-n-butylphosphine oxide (TBPO) extract Pu(IV) and Pu(VI) as the di-solvate.^{269, 408} The data of Martin and Ockenden²⁶⁹ is given in Figs. 9 and 10 for extraction of several elements into 0.1 M TOPO in cyclohexane from HNO_3 and HCl solutions. Pu(IV) and U(VI) are both extracted well ($D = 4-30$) from 3 M H_2SO_4 by 0.3 M TOPO.¹⁸⁷ The extraction of Pu(IV) as a function of nitric acid concentration is similar to that for TBP, but very much higher, while that for U(VI) and Pu(VI) show different acid dependencies. White and Ross⁴²⁷ have written a general review of the extractive properties of TOPO.

Trace quantities of U have been separated from large amounts of Pu by extracting the U with TOPO under reducing conditions from 2 M HNO_3 .³⁴

Table IV-16 is a compilation of data for the extraction of Pu(IV) by a large number of compounds of this type. The extraction coefficients were converted to 1 M extractant by using the "square law," that is by assuming that the extracted complex is dissolved in every case. The distribution coefficients were taken at 1 M HNO_3 where possible, but cases in which other ions were present or the acidity was different are noted. The extractive power relative to TBP was calculated by direct comparison in the same series of experiments where possible, or by comparison to other TBP data taken under the same stated conditions. The conversion of the phosphine oxide data to 1 M extractant generally required large extrapolations, since the experiments were done at low extractant concentrations. For this reason the numerical values of the distribution coefficients and the relative extractive power are only approximate.

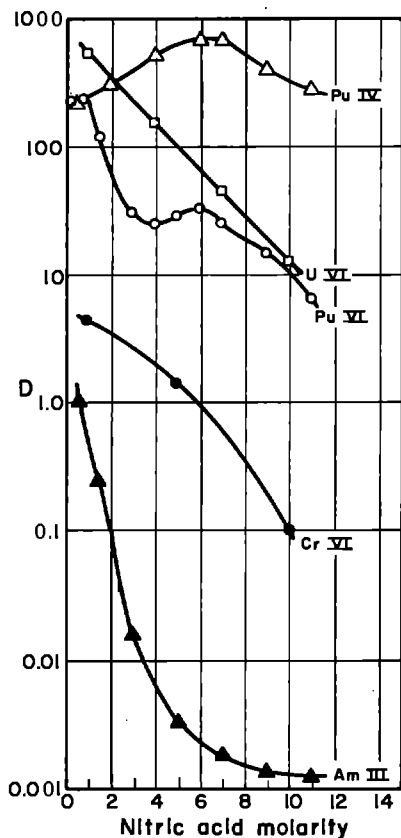

Fig. 9. Extraction of metal ions from nitric acid by 0.1 M TOPO in cyclohexane.²⁶⁹

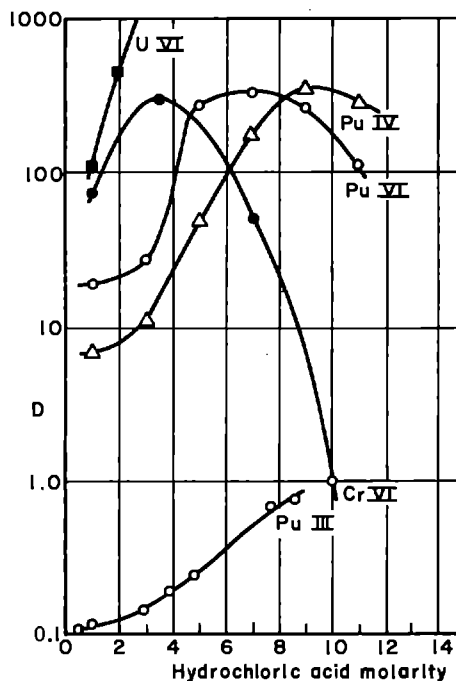

Fig. 10. Extraction of metal ions from hydrochloric acid by 0.1 M TOPO in cyclohexane.²⁶⁹

Acidic Compounds

These compounds are the mono- and di-acidic esters of phosphoric acid and related phosphonates and phosphinates. They have received considerable attention in recent years during the search for more versatile or specific extractants. In general, these compounds extract by an ion exchange type reaction analogous to chelation. In many cases the chelate compound thus formed is further solvated in the organic phase. For example the extracted complex in the extraction of Th(IV) with bis-2-ethylhexyl phosphoric acid from several acids involves the anions such as NO_3^- , Cl^- , and possibly ClO_4^- in extractions from the respective acids.³¹²

Mono-acidic compounds. Di-n-butyl phosphoric acid (DBP) and bis-2-ethylhexyl phosphoric acid (HDEHP) are the compounds that have received most attention. They have been shown to be dimeric in the organic phase in a non-polar solvent such as benzene.³¹⁰ The dimerization is presumably due to hydrogen bonding to the phosphoryl oxygen.¹³⁰ The extraction reaction can be formulated as

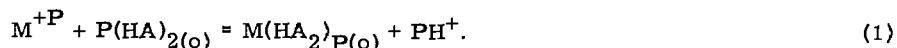

TABLE IV-16. Compiled Data on Extraction of Pu(IV) by Neutral Organo-Phosphorous Compounds

Extractant		Extractant Concentration Vol. % (M)	Nitric Acid Concentration (M) (a)	Pu Conc. (M)	D Given in Paper	D at 1 M Extractant (b)	Relative Extractability (TBP = 1.0)(c)	Reference
Tributyl (TBP)	Kerosene	19 (0.69)	1.0	T ^(d)	1.5	3.2	1.0	44
	Gulf BT "	30 (1.09)		T	3.0	2.5		92, 93
	Kerosene	40 (1.46)		T	3.5	1.6		76
	Kerosene	20 (0.73)		8×10^{-4}	1.38	2.6		281
	Benzene	20 (0.73)	~3.0	T	14.1	26.3		364
	Mesitylene	↓	↓	↓	6.4	11.9		364
	Heptane	↓	↓	↓	4.72	8.8		364
	Nonane	↓	↓	↓	5.46	10.2		364
	-----	100 (3.65)	1.0	T	36.	1.0		41
	Xylene	(1)	1.0	T	3.0	3.0		187
	n -Dodecane	30 (1.09)	3.0	T	16.1	13.5	↓	376
	Dibutyl methyl	Carbon tetrachloride	(0.5)	2 (initial)	0.0038	0.71	2.8	0.45
Dibutyl-decyl	Carbon tetrachloride	(0.5)	2 (initial)	0.0038	2.3	9.2	1.28	69
Triisobutyl	n -Dodecane	(1.09)	3	T	11.8	9.9	0.73	376
Tri- n -amyl	n -Dodecane	(1.09)	3	T	15.6	13.1	0.97	376
Tri-isoamyl	n -Dodecane	(1.09)	3	T	17.8	15.0	1.10	376
Tri- n -hexyl	n -Dodecane	(1.09)	3	T	15.6	13.1	0.97	376
Tri- n -octyl	n -Dodecane	(1.09)	3	T	15.3	12.9	0.95	376

NOTES:

- (a) Equilibrium aqueous concentrations are listed except as noted,
 (b) Calculated by assuming di-solvation and ideality in the organic phase; i. e., $D_{1M} = D_{xM} \left(\frac{1}{x}\right)^2$ where x is the concentration of the extractant.
 (c) Calculated by comparing to TBP under the same conditions under the same experimental conditions where possible. Otherwise the comparison is made indirectly. These cases are noted.
 (d) T represents tracer quantities of Pu.

Table IV-16. (Continued)

Extractant		Extractant Concentration	Nitric Acid Concentration	Pu Conc.	D Given in Paper	D at 1 M Extractant	Relative Extractability	Reference
Phosphates	Diluent	Vol. % (M)	(M) (a)	(M)		(b)	(TBP = 1.0)(c)	
Tri-2-ethyl hexyl	n-Dodecane	(1.09)	3	T	25	21	1.55	376
Tri-2-butyl	n-Dodecane	(1.09)	3	T ^(d)	28	23.5	1.74	376
Tri-3-amyl	n-Dodecane	(1.09)	3	T	18.1	15.2	1.12	376
Tri-3-methyl-2-butyl	n-Dodecane	(1.09)	3	T	24	20	1.49	376
Tri-4-methyl-2-amyl	n-Dodecane	(1.09)	3	T	22	18.5	1.36	376
Tri-sec-butyl	Amsco 125-82	(0.3)	0.5 + 0.5 M Al(NO ₃) ₃	7.1 × 10 ⁻⁵	5	56	3.85	187, 420
Tri-2-octyl	Amsco 125-82	(0.3)			4	44	3.07	187, 420
Dibutyl ethyl	Carbon tetrachloride	(0.5)	0.8 M Al(NO ₃) ₃	4.2 × 10 ⁻⁴	2.62	10.5	0.62	182
Diethyl amyl	↓	↓	↓	↓	3.76	15.0	0.89	↓
Diethyl n-butyl	↓	↓	↓	↓	3.73	14.9	0.88	↓
Diethyl isobutyl	↓	↓	↓	↓	3.69	14.8	0.87	↓
<u>Phosphonates</u>								
Dibutyl butyl	CCl ₄	0.75 M	0.6 + 0.1 M UO ₂ (NO ₃) ₂	T ^(d)	1.23	2.2	17.3	181
	CCl ₄	0.5	2 (e)	0.0038	32	128	20.4	69
Dibutyl methyl	CCl ₄	0.5	2 (e)	0.0038	29	116	20.0	69
Dibutyl decyl	CCl ₄	0.5	2 (e)	0.0038	35	140	22.3	69
Di-n-butyl phenyl	(f)	1.0	1.0	T	3.2	3.2	1.0	187
Di-sec-butyl phenyl	(f)	1.0	1.0	T	5.1	5.1	1.6	187

(c) Initial aqueous concentration.

(f) Diluent not stated, probably kerosene.

Table IV-16. (Continued)

Extractant		Extractant Concentration Vol. % (M)	Nitric Acid Concentration (M) (a)	Pu Conc. (M)	D Given in Paper	D at 1 M Extractant (b)	Relative Extractibility (TBP = 1.0)(c)	Reference
Phosphonates	Diluent							
Dibutyl butyl	n-Dodecane	1.08	1.0	T	160	137	22.0 ^(g)	375
Di-2-amyl 2-butyl	n-Dodecane	1.096	1.0	T	53	44	14.7 ^(g)	379
Dibutyl methyl	CCl ₄	0.5 M	1.0 ^(e) + 0.21 M UO ₂ (NO ₃) ₂	0.004	11.15	44.6	16.6	318
Di-isoamyl methyl	↓	↓	↓	↓	7.43	29.7	11.1	↓
Di- n-hexyl methyl	↓	↓	↓	↓	11.65	46.6	17.4	↓
Di- n-heptyl methyl	↓	↓	↓	↓	10.95	43.8	16.3	↓
Di- n-octyl methyl	↓	↓	↓	↓	13.65	54.6	20.3	↓
Di- n-nonyl methyl	↓	↓	↓	↓	24.15	96.6	36.0	↓
Di- n-decyl methyl	↓	↓	↓	↓	21.65	86.6	33.3	↓
Di-cyclohexyl methyl	CCl ₄	0.5 M	1.0 ^(e) + 0.21 M UO ₂ (NO ₃) ₂	0.004	17.35	69.4	25.9	318
Diphenyl methyl n-butyl n-hexyl methyl	↓	↓	↓	↓	1.34	5.4	2.0	↓
n-butyl n- heptyl methyl	↓	↓	↓	↓	11.60	46.4	17.3	↓
Di- n-butyl ethyl	↓	↓	↓	↓	17.85	71.4	26.6	↓
Di-isobutyl ethyl	↓	↓	↓	↓	7.58	30.3	11.3	↓
	↓	↓	↓	↓	7.67	30.7	11.4	↓

(g) Indirect comparison, i. e., to TBP under the same stated conditions, but determined in a different experiment.

Table IV-16. (Continued)

Extractant	Diluent	Extractant Concentration Vol. % (M)	Nitric Acid Concentration (M) (a)	Pu Conc. (M)	D Given in Paper	D at 1 M Extractant (b)	Relative Extractability (TBP = 1.0)(c)	Reference
Di-n -butyl n -propyl	CCl ₄	0.5 M	1.0(e) + 0.21 M UO ₂ (NO ₃) ₂	0.004	8.65	34.6	12.9	318
Di-isoamyl n -propyl					7.46	29.8	11.1	
Di-n -butyl n -butyl					9.46	37.8	14.1	
Di-n -butyl n -amyl					8.91	35.6	13.3	
Di-isoamyl n -amyl					9.00	36.0	13.4	
Di-isoamyl isoamyl					7.69	30.8	11.5	
Di-isoamyl n -octyl					8.92	35.7	13.3	
Di-n -butyl benzyl					1.91	7.6	2.8	
Di-n -butyl methoxymethyl					1.16	4.6	1.7	
Di-n -butyl ethoxymethyl					1.50	6.0	2.2	
Di 2-(n -butoxy) -ethyl-1					3.26	13.0	4.9	
Di 1-methyl-2- (n -butylcarboxy) -ethyl-1					2.35	9.4	3.5	
Di 2-(n -butyl- carboxy)- ethyl-1					2.38	9.5	3.5	
Tetra-n -butyl methylene diphosphonate					6.72		10.0	

Table IV-16. (Continued)

Extractant	Diluent	Extractant Concentration Vol. %(M)	Nitric Acid Concentration (M) (a)	Pu Conc. (M)	D Given in Paper	D at 1 M Extractant (b)	Relative Extractability (TBP = 1.0)(c)	Reference
Tetra-isoamyl methylene phosphonates	CCl ₄	0.5 <u>M</u>	1.0 ^(e) + 0.21 <u>M</u> UO ₂ (NO ₃) ₂	0.004	8.45		12.6	318
Phosphinates								
Butyl dibutyl phosphinate	CCl ₄	0.75 <u>M</u>	0.6 + 0.1 UO ₂ (NO ₃) ₂	T ^(d)	49	87	69	181
Butyl dibutyl phosphinate	CCl ₄	0.50	2 (e)	0.0038	170	510	108	69
Ethyl dihexyl phosphinate	CCl ₄	0.50	2 (e)	0.0038	200	800	127	69
Butyl dibutyl phosphinate	m-Dodecane	1.08	1.0	T	160	137		
Phosphine Oxides								
Tri-n-butyl phosphine oxide	CCl ₄	0.75 <u>M</u>	0.6 + 0.1 UO ₂ (NO ₃) ₂	T ^(d)	499	888	703	181
Tri-octyl phosphine oxide	Cyclohexane	0.1	1.0	T	236	23,600	~100 ^(g)	269
Tri-n-butyl phosphine oxide	CCl ₄	0.5	1.0 + 0.21 (UO ₂)(NO ₃) ₂	0.004	299	1,196	446	318
Tri-isobutyl phosphine oxide	CCl ₄	0.5	1.0 + 0.21 (UO ₂)(NO ₃) ₂	0.004	21.9	876	32.6	318
Tri-butyl phosphine oxide	CCl ₄	0.01	1.0	T	110	1.1 × 10 ⁶	~3 × 10 ⁵ (g)	408
Tri-octyl phosphine oxide	Amsco 125-82	0.01	0.8	T	100	1.0 × 10 ⁶	~3 × 10 ⁵	187
Tri-2-ethyl-hexyl phosphine oxide	Amsco 125-82	0.1	0.6	T	200	2.0 × 10 ⁴	~6000	187

In this equation, HA represents any monoacidic ester of phosphoric acid.

This equation has been shown to be correct for di- and trivalent ions, but tetra-valent ions in general show a more complex behavior. The extracted complex is sometimes further solvated in the organic phase and nitrate, chloride, and even perchlorate complexes may be involved in the extraction reaction, depending on the specific aqueous conditions employed. Thus, no general reaction can be proposed which will account for all of the observed behavior.

Kosyakov *et al.*²³⁸ studied the extraction of Pu(IV) and other actinides from nitric acid solutions by several dialkylphosphoric acids. Their results for Pu(IV) are shown in Fig. 11. The distribution coefficient increases as the length of the normal

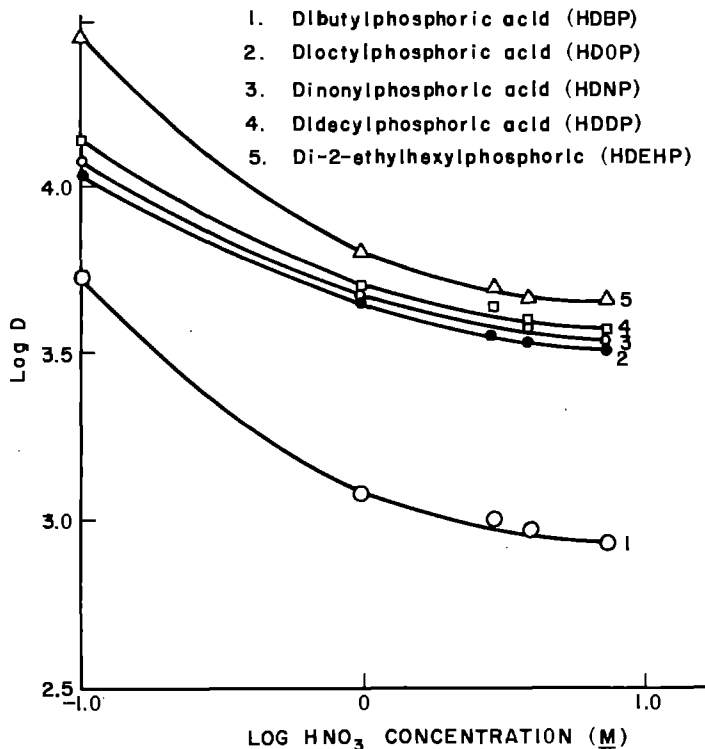

Fig. 11. Extraction of Pu(IV) by dialkylphosphoric acids (0.5 M in isoctane) from HNO₃ solutions.²³⁸

alkyl chain is increased from butyl to decyl, but that for 2-ethylhexyl is greater than any of these. The non-linearity of the slope of these extraction curves is ascribed to nitrate complexing in the extracted species. The acid dependency was determined by extraction into HDEHP from HClO₄ solutions at a constant ionic strength of 1.0 and found to be inverse first power in the region from approximately 0.05 to 1.0 M H⁺. The Pu is probably extracted as a hydrolyzed species at low acid concentrations. The distribution coefficient was found to vary directly as the square of the HDEHP concentration.

The distribution coefficients for the extraction of Am(III), Pu(IV), Np(V) and U(VI) into HDEHP from nitric acid are shown in Fig. 12. The discontinuity in the Np(V)

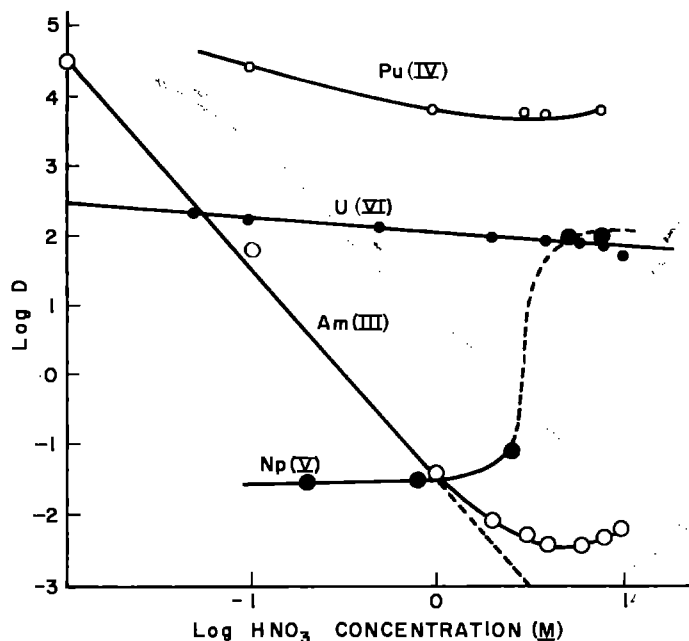
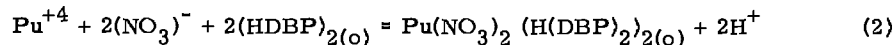

Fig. 12. Extraction of various actinides into 0.5 M HDEHP (isooctane diluent) from HNO₃ solutions.²³⁸

curve at high acid concentrations is due to disproportionation of Np(V) into Np(IV) and Np(VI), both of which are more extractable than Np(V). The minimum in the Am(III) curve at high acid concentrations is probably due to nitrate complexing of the extracted Am species.

Horner and Coleman¹⁸⁷ get a different result for the extraction of Pu(IV) by HDEHP. As shown in Fig. 13, the extraction curve is concave downward with increasing HNO₃ concentration using 0.01 M HDEHP in Amsco 125-82. The magnitude of distribution coefficients are very much larger than those of Kosyakov *et al.*,²³⁸ if the second power dependence on the extractant concentration is taken into account. Another difference is the decreased distribution coefficient at 0.1 M acid. Horner and Coleman ascribe this decrease to hydrolysis of the Pu(IV). Horner and Coleman prepared Pu(IV) by reduction to Pu(III) with hydroxylamine nitrate, and reoxidation and stabilization with sodium nitrite, while Kosyakov *et al.*²³⁸ did not state their method of preparation of Pu(IV).

Dreze and Duyckaerts¹²¹ investigated the extraction of Pu(IV) by di-n-butyl phosphoric acid (HDBP) from nitrate solutions as a function of nitric acid concentration, nitrate concentration, HDBP concentration, and ionic strength. Representative results are shown in Figs. 14 and 15. These experimenters were able to invoke the known stability constants of Pu(IV) nitrate complexes to fit the various functional dependencies. They consider the extraction reaction to be



for which they calculate the equilibrium constant to be $(1.7 \pm 0.3) \times 10^9 (\text{m/l})^2$.

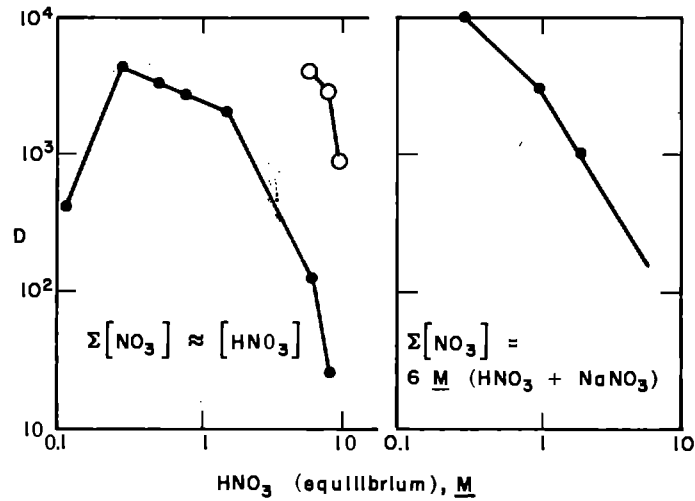

Fig. 13. Pu(IV) extraction by di(2-ethylhexyl)-phosphoric acid: effect of nitric acid and sodium nitrate concentration. ● 0.01 \underline{M} D2EHPA; ○ 0.1 \underline{M} D2EHPA; diluent, Amsco 125-82. Plutonium reduced with hydroxylamine nitrate, reoxidized and stabilized with 0.1-0.5 \underline{M} NaNO_2 .¹⁸⁷

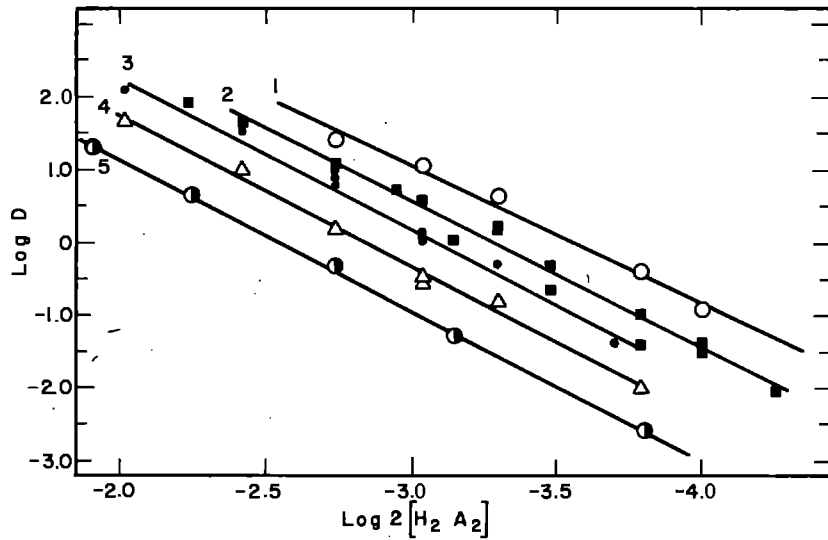

Fig. 14. Variation of the distribution coefficient of Pu(IV) as a function of the concentration of the dimer, $(\text{HDBP})_2$ in benzene.¹²¹ $\text{HNO}_3 + \text{NaNO}_3 = 6 \underline{M}$; HNO_3 concentrations:

Curve 1-0.5 \underline{M}	Curve 4-4 \underline{M}
Curve 2-1 \underline{M}	Curve 5-6 \underline{M}
Curve 3-2 \underline{M}	

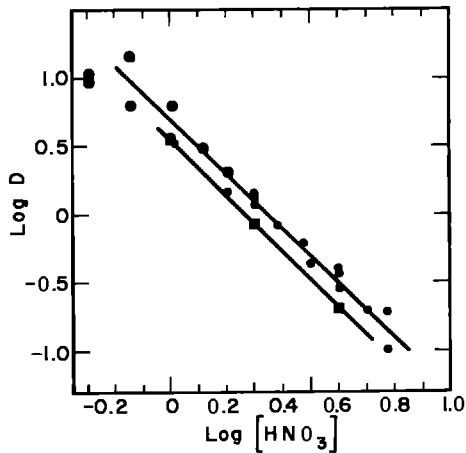

Fig. 15. Variation of the distribution coefficient of Pu(IV) from nitrate solutions by HDBP as a function of HNO₃ concentration.¹²¹

● HNO₃ + NaNO₃ = 6 M

■ HNO₃ + NaNO₃ = 4 M

other workers are included also. A later similar study was made on the solvent concentration dependency for the same system.²²⁶

On the other hand, Shevchenko and Smelov³⁶⁸ interpreted their results on the same system by assuming the extracted complex to be nitrate free.

Early work on the Pu(IV)-HDBP-HNO₃ system was done by Stewart and Hicks,³⁹⁴ who found a strong lowering of the distribution coefficient when dibutyl ether was used as the diluent instead of hexane.

HDBP has been used as the extractant in a procedure to determine Pu²⁴¹ by extraction and counting in a liquid scintillator.²⁵⁶

Kimura²²⁵ determined the acid dependency of the distribution coefficients of many elements extracted from 50 volume % HDEHP from HCl solutions. His results, in the form of a periodic table, are shown in Fig. 16 for comparison. Some results from

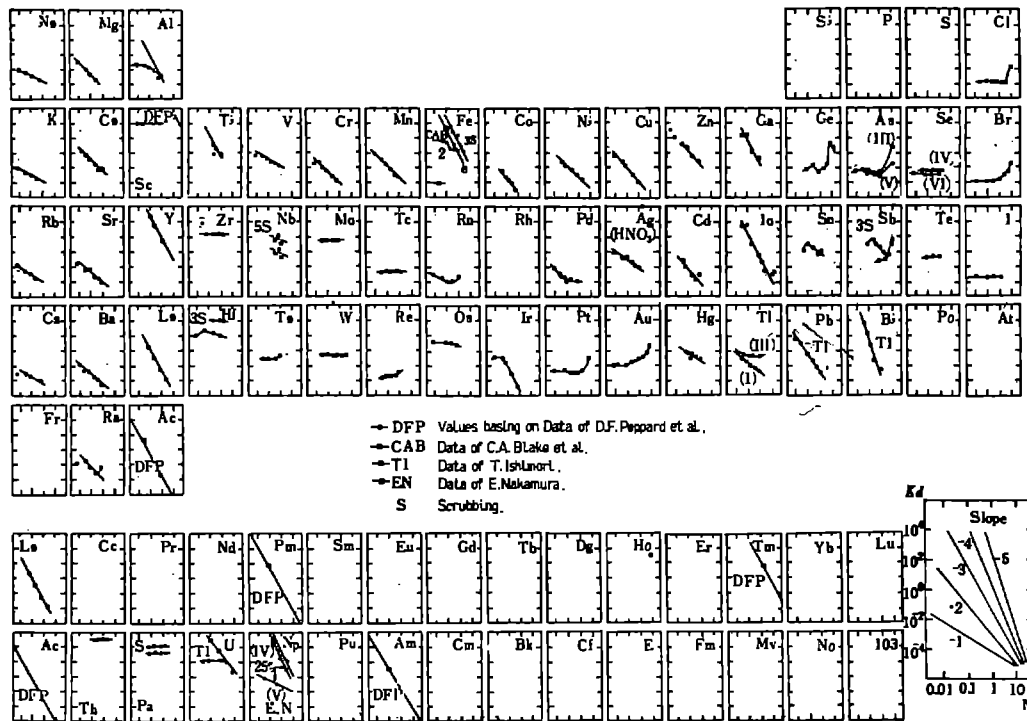

Fig. 16. Extraction of elements from HCl solution by 50% HDEHP in toluene as a function of acid concentration.²²⁵

Di-acidic compounds. Mono-2-ethylhexylphosphoric acid has been most extensively studied of this type of compound. It is polymeric in the organic phase in a non-polar solvent, such as benzene^{310,130} and extracts primarily by the ion exchange reaction.

Kosyakov *et al.*²³⁸ studied the extraction of Am(III), Pu(IV), Np(V), and U(VI) by mono-2-ethylhexylphosphoric acid (H₂MEHP) from nitric acid solutions with results shown in Fig. 17. The distribution coefficients are in general higher for the same aqueous conditions than those of HDEHP. Pu(IV) can be returned to the aqueous phase by washing with a 5% solution of potassium oxalate.

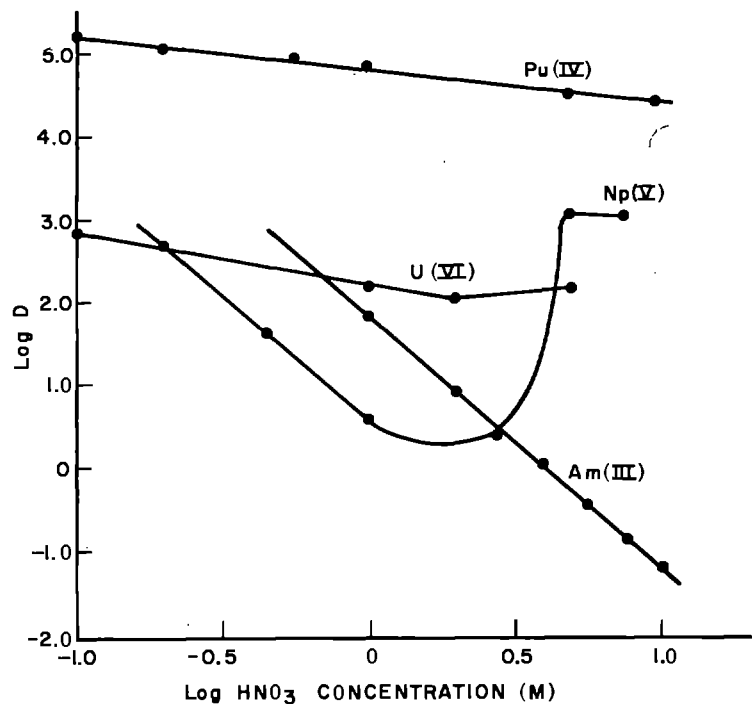

Fig. 17. Extraction of various actinides into 0.2 M H₂MEHP (isooctane diluent) from HNO₃ solutions.²³⁸

Peppard *et al.*^{313, 270} studied the extraction of several actinides by H₂MEHP from HCl solutions (Fig. 18). The distribution coefficient for Np(IV) at 12 M HCl is over 10³ and is a factor of 10⁴ greater than the other non-tetravalent species studied. Separation from Pu is accomplished by reduction of the Pu to the tripositive state. Gindler *et al.*¹⁴⁶ used this method to purify Pu²³⁶ for fission counting. The Np(IV) can be returned to the aqueous phase by the addition of TBP to the organic phase, resulting in a great reduction in the distribution coefficient because of anti-synergistic (or antagonistic) effect of these reagents, (cf Mixed Extractants, p. 71).

Applications of acidic compounds. Acidic compounds have been used in several applications in Pu chemistry. Kosyakov *et al.*²³⁸ used HDEHP to purify Am(III) from other actinides of higher valence state, and accomplish their mutual separation

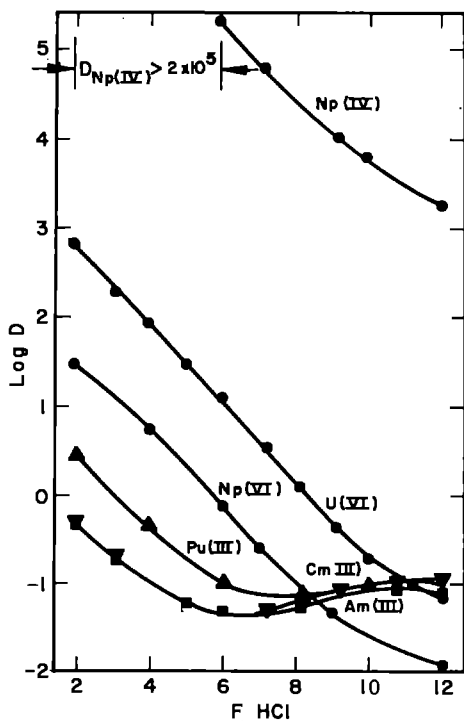
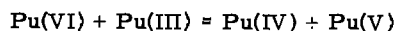

Fig. 18. Extraction of some actinide cations into 0.48 F H₂MEHP in toluene as a function of HCl concentration.³¹³

Am(III), Pu, and U, are extracted from 0.01 M HNO₃ after stabilization of the Np in the pentavalent state with NaNO₂. Np(V) is then oxidized to Np(VI) by an oxidizing agent and extracted by HDEHP, and recovered from the organic phase by reduction to Np(V) and washing with 0.1 M HNO₃. Am(III) is back-extracted from the HDEHP by 3 M HNO₃, and the Pu recovered by reduction to Pu(III) and back extraction with 3 M HNO₃. Finally, the U(VI) is returned to the aqueous phase by back extraction with ~1 M ammonium carbonate.

Chudinov and Yakovlev⁸⁹ extracted U and Pu away from Np(V) with HDEHP as a preliminary step in the calorimetric determination of Np(IV) with arsenazo (III). They state a Np sensitivity of 0.04 γ/ml by this method.

DBP was used by Markin and McKay²⁶⁸ to prepare a pure Pu(V) solution in 0.2 M HNO₃. The method was to extract Pu(IV) from a mixture of Pu(III) and Pu(VI). The reaction



is thus driven to completion leaving a pure Pu(V) solution in the aqueous phase.

Peppard *et al.*³¹¹ used H₂MEHP in various diluents, and tri-n-octyl phosphine oxide to effect a sequential separation of various tri-, tetra-, and hexavalent ions from urine.

Peppard *et al.*³¹⁴ used HDEHP to separate Bk from other tripositive actinides and from Pu. The Bk is oxidized to Bk(IV) in 10 M HNO₃ by 1 M KBrO₃ and extracted away from tripositive actinides. The Bk(IV) is then back extracted into 8 M HNO₃ by reduction with H₂O₂. Pu is not reduced to Pu(III) under these conditions and remains in the organic phase.

Amine Extractants

These compounds are long-chain alkyl or aryl primary, secondary, and tertiary amines, and quaternary amine salts. Moore²⁸⁶ and Coleman *et al.*⁹⁵ have given general reviews of the extraction of inorganic species by these compounds. The amines react with acids to form an ion-association complex which is soluble in the organic phase, illustrated by a tertiary amine

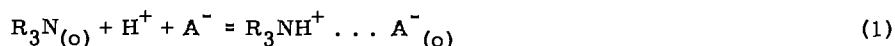

A may be either a simple anion or the anion of a complex metal acid. This complex may undergo a further reaction with another anion in a manner analogous to anion exchange

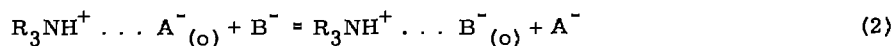

Much work has been done on Pu and other actinides with these compounds, in process and analytical applications. They have much higher distribution coefficients than TBP for U and Pu(IV), and show much less deleterious effects on the distribution due to high radiation fields because the radiolysis products do not interact with the extractant to produce synergistic mixtures, (cf Mixed Extractants, p. 71).

The treatment here will be in the order nitrate, chloride, sulfate, and other. The structure and nature of the amine exert a great influence on the extractability of Pu.

Nitrate Systems

The relative extractability of Pu in nitrate solutions is in the order Pu(IV) > Pu(VI) > Pu(III) and the extractive power of the amines varies in the order

quaternary > tertiary > secondary > primary.¹⁸⁷ Pu(IV) extracts very strongly and selectively in analogy with anion exchange.

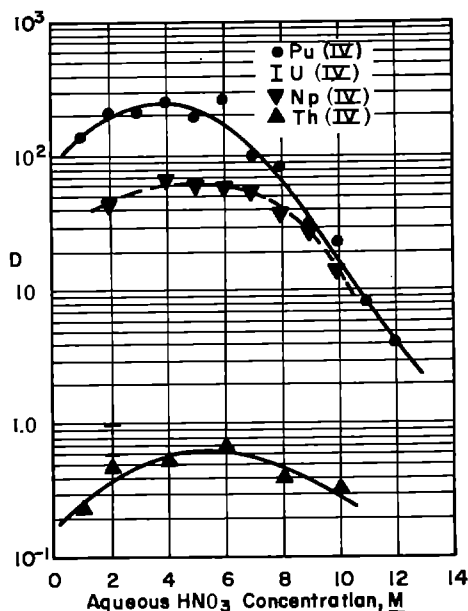

Fig. 19. The extraction of the quadravalent actinide nitrates by 10 v/o TOA in xylene.²¹⁹

Keder et al.²¹⁹ also determined the extraction properties of hexavalent, trivalent and pentavalent actinides as a function of nitric acid concentration, with results shown in Figs. 20 and 21. The maximum distribution coefficients for all these species is very much less than for Pu(IV) and Np(IV), indicating an easy separation of these elements from other actinide elements. For the hexavalent species, the amine concentration dependencies of the distribution coefficients were between first and second power, permitting no unambiguous assignment of the extracted complex. The slope of the Am(III) curve was unity, while that for Pu(III) was approximately 1.5. No explanation of this fact was given.

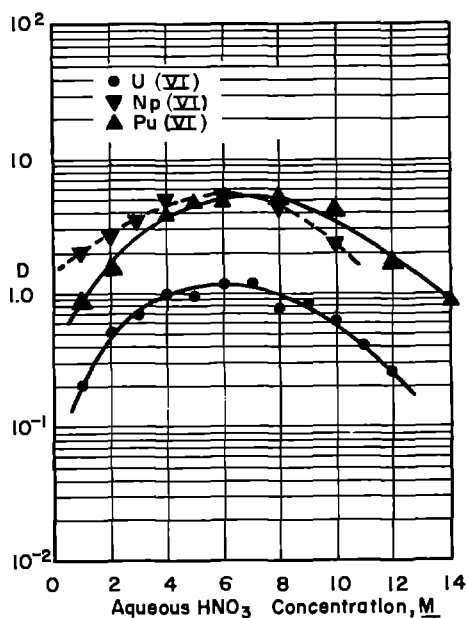

Fig. 20. The extraction of the hexavalent actinide nitrates by 10 v/o TOA in xylene.²¹⁹

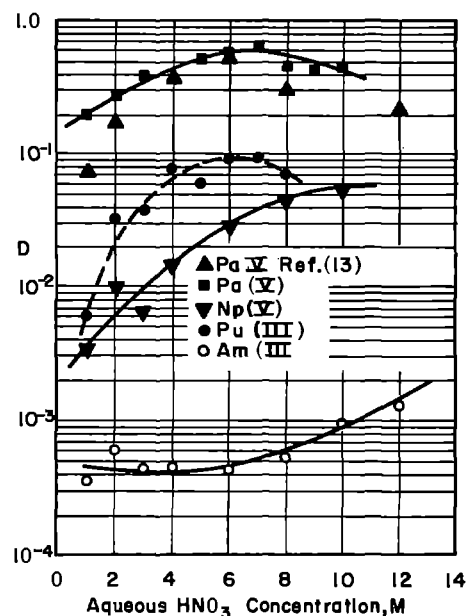

Fig. 21. The extraction of pentavalent and trivalent actinide nitrates by 10 v/o TOA in xylene.²¹⁹

Keder *et al.*²¹⁸ determined that the extracted complex is $M(\text{NO}_3)_6^{2-}$ for quadrivalent actinides and $\text{MO}_2(\text{NO}_3)_3^-$ for hexavalent actinides by spectrophotometric measurements.

Horner and Coleman¹⁸⁷ and Weaver and Horner⁴²⁰ have determined the distribution coefficients of Pu(IV), Pu(III), and Pu(VI) for a number of amines from HNO_3 solutions, with results shown in Figs. 22, 23, and 24. Their Pu(IV) results for unsalted tri-n-octylamine (TOA) agree qualitatively with Keder *et al.*²¹⁹ and Baroncelli *et al.*,³⁶ but reach the maximum at a lower HNO_3 concentration. The other classes of amines reach a maximum at around 9 M HNO_3 . The effect of salting with NaNO_3 at a constant nitrate concentration is to increase the distribution coefficient at lower acidities. Pu(III) and Pu(VI) show very much lower distribution coefficients with all classes of amines (Fig. 23) although $\text{Al}(\text{NO}_3)_3$ salting raises the $D_{\text{Pu(III)}}$ to a relatively high value with tertiary amines (Fig. 24).

Baroncelli *et al.*³⁶ measured the distribution of Pu(IV) between HNO_3 solutions and "tricaprylamine" (TCA, sold as "Alamine 336," a mixture of n-octyl and n-decyl-amines), with similar results. The amine was diluted in "Solvesso 100," an aromatic naphtha. The extraction reached a maximum of approximately $D = 140$ at 4 M HNO_3 , and was strongly depressed by the presence of macro uranyl ion, which saturates the extractant. In experiments varying the concentration of the TCA the formation of the hexanitrate Pu(IV) complex is confirmed, but the slope of the $\log D_{\text{Pu}}$ vs $\log \text{TCA}$ curve is 1.4 in the presence of 1.5 M uranyl ion. The corresponding slope for U is 1, indicating the formation of a uranyl trinitrate complex.

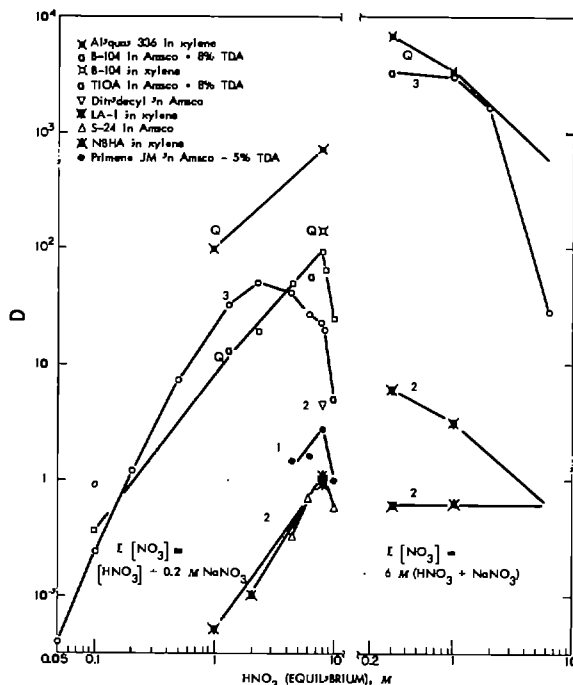

Fig. 22. Pu(IV) extraction by 0.1 M amines: effect of nitric acid and sodium nitrate concentrations. Amine class: (Q) quaternary ammonium, (3) tertiary, (2) secondary, (1) primary amine. Pu(IV) stabilized with 0.04-0.1 M NaNO₂. Amsco 125-82, TDA = branched primary tridecanol.¹⁸⁷

Baroncelli *et al.*³⁶ also determined the separation factors for Pu from initially 1.5 M U ion and 4 M HNO₃ by amine extractions with tri-n-dodecyl amine ("tri-laurylamine," TLA) in an aromatic diluent ("Solvesso 100") and a paraffinic diluent ("Shellsol T"), and found them to be similar, around 40. The TLA-Shellsol mixture had about 5% nonanol to prevent formation of a third phase by increasing the solubility of the complex in the organic phase. Valentini *et al.*⁴⁰⁹ achieve maximum separation from U by extracting Pu from 2 M HNO₃.

Other work with tertiary amine nitric acid systems with generally similar results includes that of de Trentinian and Chesné¹¹⁶ and Chesné⁸⁴ on TLA extraction of TL(IV), U(VI), Np(IV), Np(VI) and Pu(IV); Knoch²³² and Knoch and Lindner²³¹ on tri-iso-octylamine extraction of Pu(IV), U(VI), Zr, and Ru. Bertocci⁴² found that, with tri-isononyl amine (TNA, tri-3, 5, 5-trimethylhexylamine), the $D_{Pu(IV)}$ vs HNO₃ concentration curve was still increasing at 6 M HNO₃, in contrast to work on other amines.

Wilson⁴³⁰ found that perchloric acid is a very good stripping agent for Pu(IV) in TOA solutions. The D_{Pu} value was 0.04, both in 1 M HNO₃ + 1 M HClO₄ and 0.8 M HNO₃ + 0.2 M HClO₄. Bertocci⁴² found that Pu(IV) was not stripped well from TNA solutions by NH₂OH·HCl solutions, in contrast to expectations. Valentini *et al.*⁴⁰⁹ used 1 M H₂SO₄ to strip Pu(IV) from TLA with good results.

Several processes for the separation of Pu and U from irradiated U using tertiary amines have been proposed. Wilson⁴²⁹ used TLA + 2% Octanol in kerosene to extract Pu(IV) from 4 M HNO₃, and stripped the Pu by reduction to Pu(III) with ferrous sulfamate. Chesne *et al.*⁸⁵ used the same extraction system, but stripped the Pu(IV) by a HNO₃-H₂SO₄ mixture. Valentini *et al.*⁴⁰⁹ used the TLA-HNO₃ system.

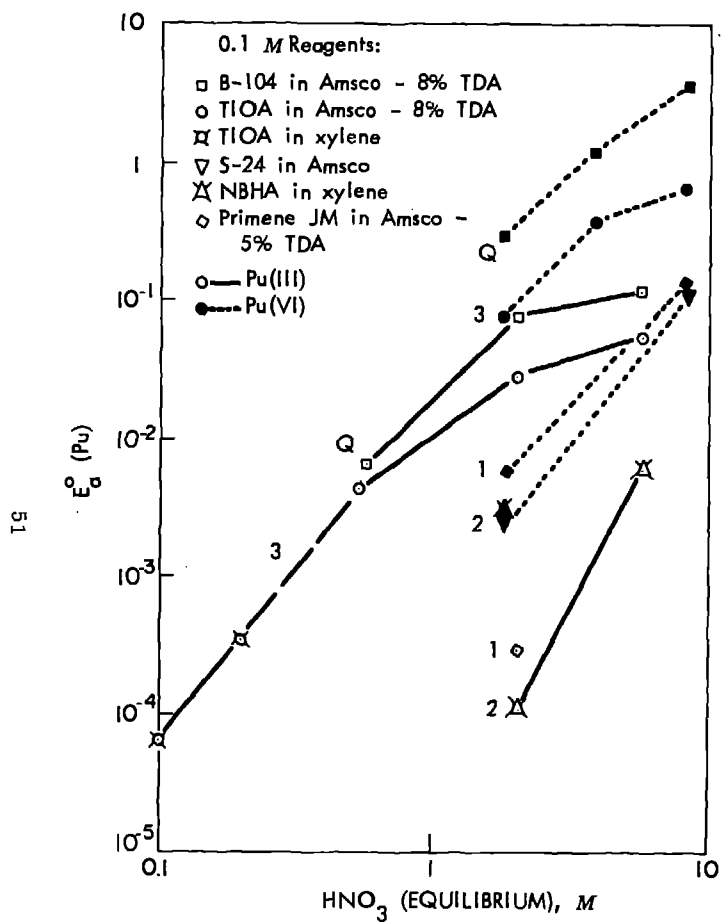

Fig. 23. Pu(III) and Pu(VI) extraction by 0.1 M amines: effect of nitric acid concentration. Amine class: (Q) quaternary ammonium, (3) tertiary, (2) secondary, (1) primary amine. Pu reduced with 0.03 M ferrous sulfamate plus 0.05 M excess sulfamic acid, or oxidized with AgO .¹⁸⁷

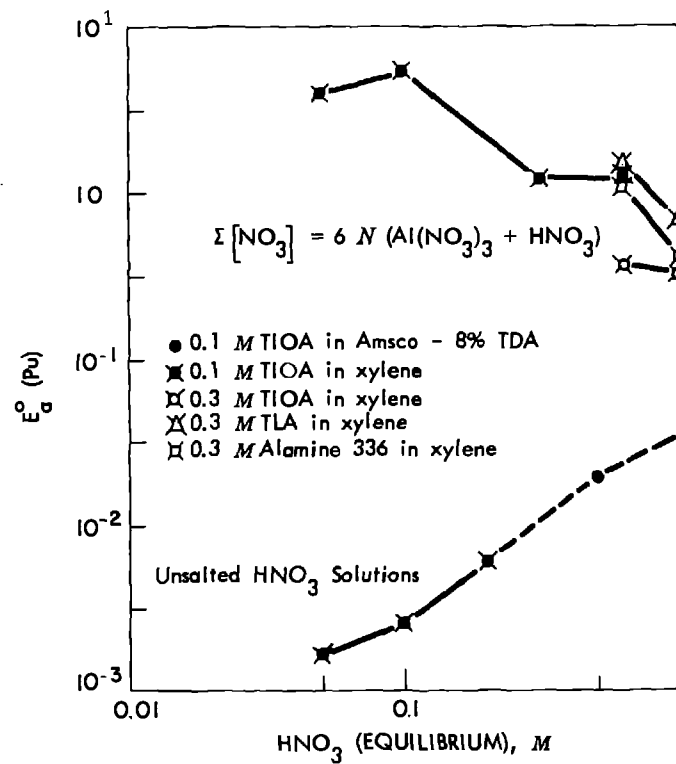

Fig. 24. Extraction by tertiary amines from solutions of Pu(III) in nitric acid with and without aluminum nitrate salting. Plutonium reduced with 0.03 M ferrous sulfamate plus 0.05 M excess sulfamic acid.¹⁸⁷

The fact that Pu(III) does not extract into tertiary amines has been made the basis of a Np-Pu separation.³⁵⁷ The Np is extracted as Np(IV) away from Pu(III) in a nitric acid solution.

Winchester and Maraman⁴³¹ made a study of the decontamination of Pu in an experimental pyrometallurgical laboratory from Fe, Co, Zr, Mo, Ru, and Ce by both TBP and amine extraction. A summary of their results in terms of decontamination factors for Pu is given in Table IV-17. They concluded that the best separation of Pu from these metals was obtained in the secondary amine system and described a batch equilibration process for recovery of Pu on a 300-gram scale in a metallurgical laboratory.

The Pu and U complexes have limited solubility in the organic phase, and separate as a third phase at high metal concentration. The addition of a small fraction of polar constituent, e. g. octanol, into the organic phase, increases the solubility of the extracted complex. Baroncelli *et al.*³⁵ have made a study of this effect, and also of the effect of nitrous acid added to stabilize quadrivalent Pu. They found that nitrous acid can have either an enhancing or depressing effect on the distribution coefficient, depending on the nitric acid concentration, while the long chain alcohol always has a depressing effect. At equal molar nitrous acid and alcohol concentration in the organic phase, the distribution coefficient is at a maximum. This effect is explained in terms of the formation of an alcohol-nitrous acid complex in the organic phase.

TABLE IV-17. Decontamination Factors for Impurities in Plutonium in Various Solvent Extraction Processes.⁴³

Element	Initial concentration (g/l)	TBP	Decontamination factors for ^(a)			
			Primary ^(b) amine	Secondary ^(c) amine	Tertiary ^(d) amine	Quaternary ^(e) amine
Fe	1.26	74	> 42	120	--	--
Co	1.86	> 300	> 31	> 80	> 60	> 52
Zr	0.34	44	> 22	92	31	> 52
Mo	0.17	> 100	> 8	> 78	> 18	> 9
Ru	0.98	1.3	12	38	16	13
Ce	0.36	2.1	25	> 67	> 32	> 29
Pu	60.58	--	--	--	--	--

Notes:

(a) Procedure consisted of 3 equal volume extractions with 35 vol. % reagent in Gulf BT Solvent (aliphatic hydrocarbon) from 8 M HNO₃ solution (except primary amine extraction in which 6 M HNO₃ was used). The secondary, tertiary, and quaternary amines had 10 vol. % decyl alcohol. The solutions were stripped with 3-1/3 volume portions of 0.1 M hydroxylamine nitrate.

(b) Rohm and Haas Company "Primene JM-T"

(c) Rohm and Haas Company "Amine 9D-178."

(d) TIOA.

(e) Sterwin Chemical Company "Roccal."

Maeck *et al.*²⁶² determined the distribution of a large number of elements for quaternary ammonium compounds between various aqueous solutions and methylisobutyl ketone ("hexone"). The aqueous solutions considered were NaOH, HNO₃, H₂SO₄, HCl,

and HF. No extraction of Pu(IV) or Pu(VI) was found at any concentration of H_2SO_4 , NaOH, and HF. The results for HNO_3 and HCl are given in Figs. 25 and 26 as percent extractions from equal phase volumes as a function of aqueous acidity in the form of periodic tables. Berkman and Kaplan⁴⁰ found that tetrabutylammonium nitrate (TBAN) added to Pu(IV) extracted into hexone caused the formation of a hexanitrate Pu(IV) species, while in the absence of TBAN the tetranitrate appears to be stable. A procedure for radiochemical determination of Np and Pu based on this extraction system using aluminum nitrate as a salting agent has been developed by Maeck *et al.*²⁶¹ They report a better decontamination from fission products, particularly Zr, than is obtainable in other amine systems.

The quaternary amine "Hyamine 1622" has been used to extract Pu(IV) from HNO_3 solutions as part of an analytical procedure for Pu.⁴⁸

Chloride Systems

Pu(IV) and Pu(VI) extract well from HCl solutions by amines, while Pu(III) is poorly extracted, in analogy with the strong base anion exchange system. Plutonium chloride systems have found application mainly in analytical and radiochemical work rather than in processes because of the corrosive properties of HCl solutions.

Keder²¹⁷ measured the distribution coefficients of tetra- and hexavalent Pu, Np, and U from HCl solutions into tri-n-octylamine (TOA). The dependence of the distribution coefficients on HCl concentration is shown in Figs. 27 and 28. In every case, the slope of the log D vs log TOA concentration curve is near 2, indicating that the extracted complex has two TOA molecules for both valence states. Pu(IV) is much more extractable than is Np(IV) and U(IV) under the same conditions. The hexavalent actinides are more extractable than the tetravalent in this system.

Shevchenko *et al.*³⁶⁶ obtained similar results for Pu(IV), and found that the distribution coefficient was approximately 0.005 for Pu(III) extracted into 20% TOA in xylene.

Moore^{282, 283} extracted tracer Pu(VI) with 5% tri-isooctylamine (TIOA) in xylene from 4.8 M HCl, using 0.01 M potassium dichromate as a holding oxidant. Niobium and ruthenium extracted to some extent, but separation from these elements is possible by scrubbing with 5 M HCl and reductive stripping of the Pu. Th(IV) or trivalent and lower species did not extract. The tri-laurylamine (TLA)-HCl system has been used to separate Pu(IV) before spectrographic analysis of other elements.²³⁴

Sulfate Systems

Shevchenko and Zhdanov³⁷³ investigated the extraction of Pu(IV) from H_2SO_4 solutions by TOA. They showed that the extracted complex contains 2 amine molecules. The sulfuric acid dependence from 0.1 M TOA is shown in Table IV-18. The decrease in the distribution coefficient at low acidity is ascribed to Pu(IV) polymerization. As the acid concentration is increased, the decrease in $D_{Pu(IV)}$ is ascribed to the formation of an amine bisulfate complex.

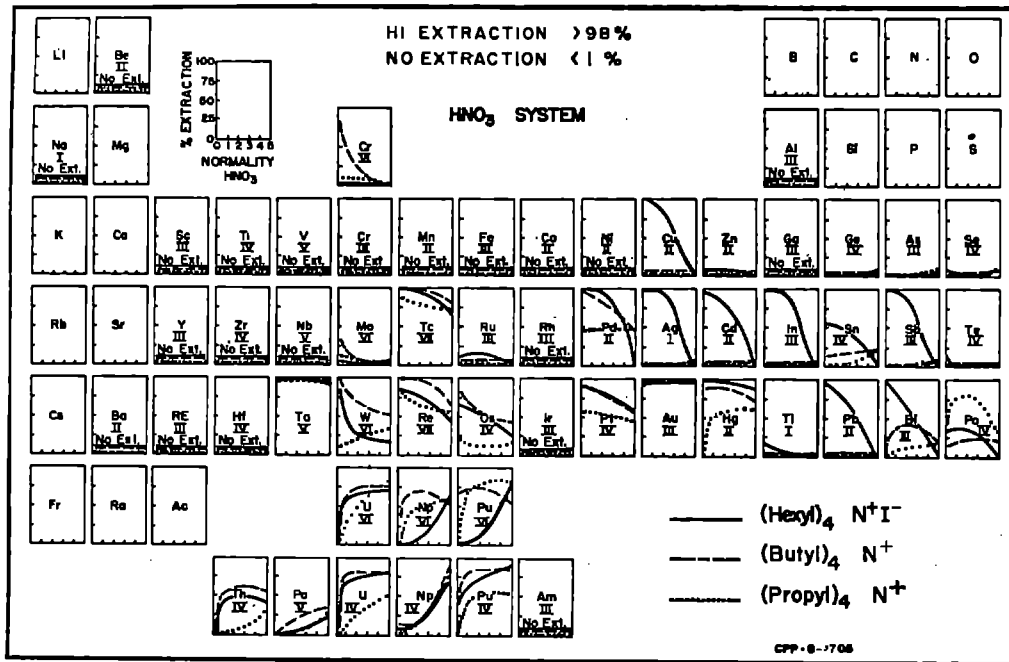

Fig. 25. Extraction of elements as tetraalkyl amine complexes from nitric acid.²⁶²

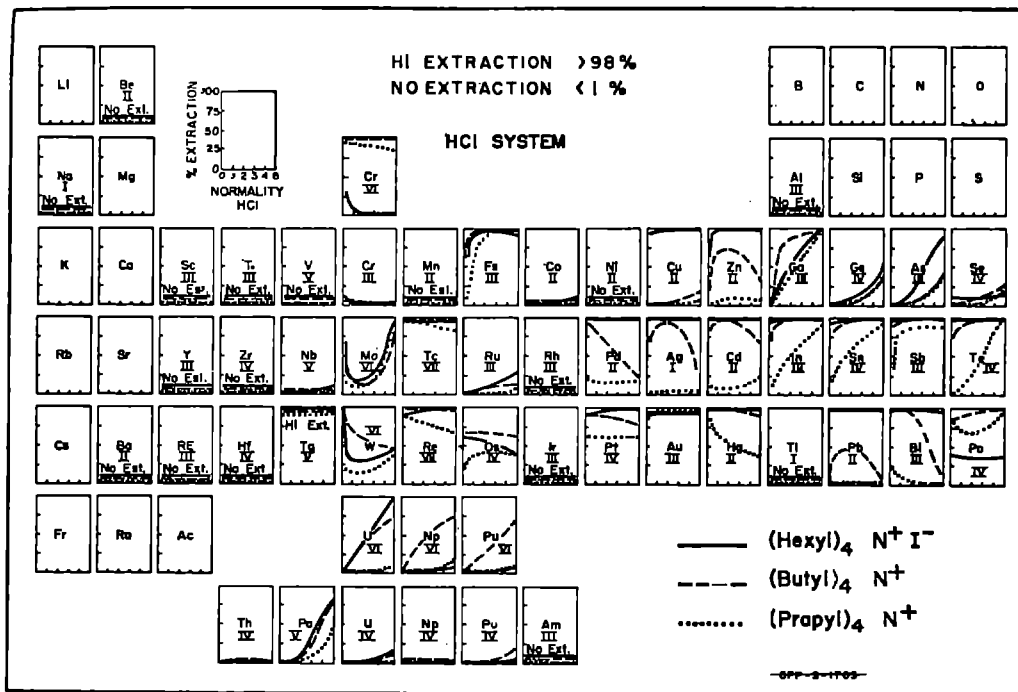

Fig. 26. Extraction of elements as tetraalkyl amine complexes from hydrochloric acid.²⁶²

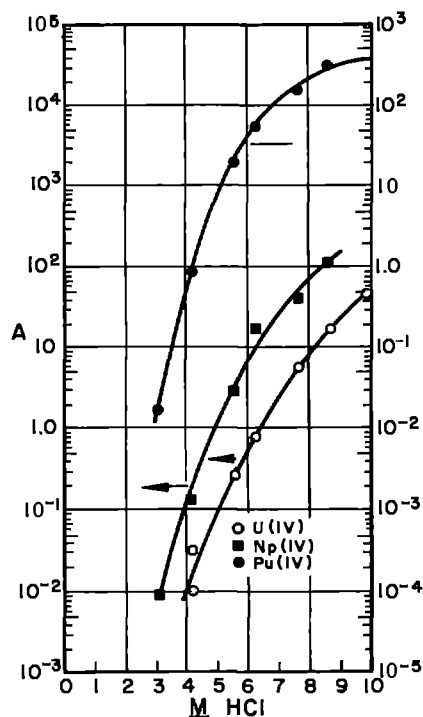

Fig. 27. Extraction of U(IV) and Np(IV) by 10% TOA and Pu(IV) by 1.0% TOA from HCl solutions.²¹⁷

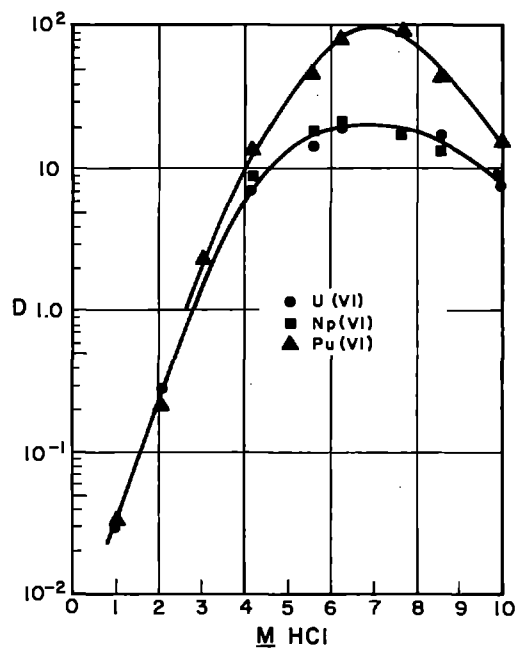

Fig. 28. Extraction of hexavalent U, Np, and Pu from HCl solution with 1.0% TOA in xylene.²¹⁷

TABLE IV-18. Dependence of the Distribution Coefficient for Pu(IV) Between Aqueous Sulfuric Acid and Tri-n-Octylamine.³⁷³

H ₂ SO ₄ Concentration at equilibrium (M)	D _{Pu(IV)}
0.01	11.3
0.037	15.2
0.1	43
0.323	18.2
0.88	0.415
2.44	0.008

(a) Initial TOA concentration 0.1 M, Pu(IV) concentration 2.34×10^{-4} M.

they conclude that in this case the anion exchange process does not operate.

Extractions from mixtures of H₂SO₄ and HNO₃ proceeded by the formation of the same amine Pu sulfate complex above, but the distribution coefficient decreased with increasing HNO₃ concentration because of the formation of amine nitrate complex. This effect is illustrated by the data in Table IV-19.

Vdovenko *et al.*⁴¹² investigated the extraction of Pu(IV) by a mixture of 7 to 9 carbon primary aliphatic amines dissolved in chloroform. They determined that the extracted complex involves 4 amine molecules, i. e. $(RNH_3)_4Pu(SO_4)_4$, by the amine concentration dependence method, and by direct macroscopic measurements of the stoichiometry of the reaction. From comparisons of the adsorption spectra in the aqueous and organic phases, they conclude that the Pu(IV) exists primarily as a neutral sulfate complex in the aqueous phase. Therefore,

TABLE IV-19. Distribution Coefficients of Pu(IV) from H₂SO₄ Solutions into Primary Amines as a Function of Increasing HNO₃ Concentration.^{412*}

Concentration of HNO ₃ (M)	0	0.05	0.10	0.20	0.30	0.50	0.90	1.50
D _{Pu(IV)}	66.3	63.3	50.1	14.6	2.08	0.11	0.01	----

*Amine concentration 0.06 M, H₂SO₄ concentration 0.2 N.

By contrast, Horner and Coleman¹⁸⁷ get a third-power dependence on amine concentration for extractions of Pu(IV) from H₂SO₄ solutions by primary amines. They also determined distribution coefficients for Pu(IV) of several secondary and tertiary amines. Their results are shown in Fig. 29, showing the successive lowering of the distribution coefficients in going to more complex amine types. They report variable

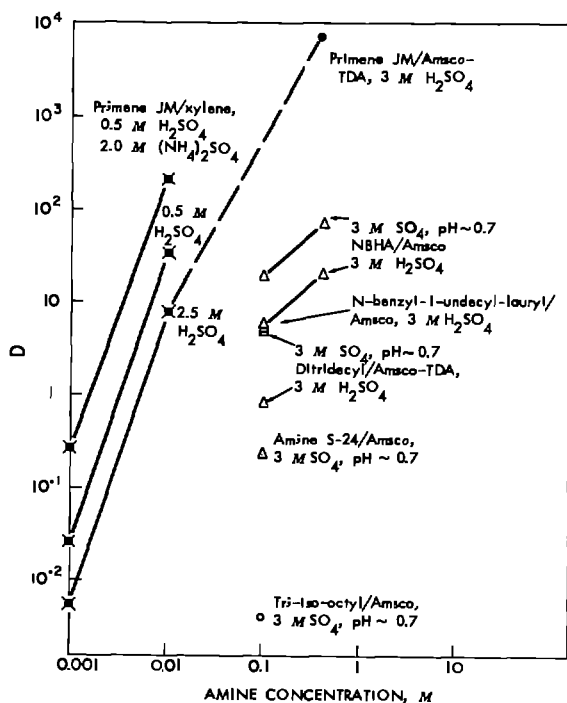

Fig. 29. Extraction of Pu(IV) from sulfuric acid and acidic sulfate solution by primary, secondary, and tertiary amines. Diluents: xylene, Amsco 125-82, or 95% Amsco 125-82-5% tridecanol. For primary amine extraction, Pu reduced with hydroxylamine sulfate, reoxidized and stabilized at (IV) with 0.5 M NaNO₂. Others stabilized at (IV) with 0.1-0.5 M NaNO₂.¹⁸⁷

distribution coefficients for Pu(III) by primary amines from sulfuric acid solutions, ranging from ~5 to >> 100 with 0.1 M amines. This behavior is attributed to partial oxidation of Pu(III) to Pu(IV), even in the presence of holding reductants.

These authors propose a process for recovery of Pu from sulfuric acid decladding solutions based on primary amine extraction.¹⁸⁶

The primary amine-H₂SO₄ system has been used for determination of Pu in biological material, e. g. urine or solution of bone ash.⁶¹

Other Systems

Moore²⁸⁵ found that the hexavalent actinides U(VI) and Pu(VI) could be quantitatively extracted from 1 M acetic acid solutions and 1 M acetic acid - 0.1 M nitric acid solutions by 5% TIOA-xylene. Of the fission products only Ru, Zr, and Nb extracted appreciably, and these could be scrubbed with 5 M HCl. A preliminary ferric (or uranyl) hydroxide precipitation in the presence of niobium carrier improved the decontamination from these elements. The U and Pu were leached from the insoluble Nb₂O₅ with 1 M acetic acid. The uranium could be stripped with dilute HNO₃ or HCl, NH₄OH or ammonium bicarbonate. The Pu(VI) could be stripped by these reagents or reductively stripped, since Pu(IV) and Pu(III) do not extract under these conditions.

Alcohols, Ketones, Ethers, and Amides

These compounds have in common the fact that they contain a basic oxygen atom which can solvate a proton or metal atom. This type of extractant was once very popular, but the newer organo phosphorous compounds and amines have received more attention in recent years. Nevertheless, they are still important in laboratory and process separations. Indeed, one of the large-scale processes for the processing of irradiated U, the "redox" process, uses methylisobutylketone (MIBK or "hexone") as the primary extractant for U and Pu²⁵¹ as do several laboratory procedures. The extractive properties of the ethers for U, Fe, and other elements have been known for many years.

Nitrate systems have received by far the most attention as extraction media for Pu. Both Pu(IV) and Pu(VI) are extractable at high nitric acid concentrations, or at moderately high nitrate concentrations provided by a salt such as aluminum nitrate. Pu(III) is practically inextractable at any nitrate concentration. The extracted species depends on the aqueous phase composition. It has been shown that, for example, the extraction of Pu(VI) from nitric acid solutions by dibutyl carbitol (DBC, the dibutyl ether of diethylene glycol) the extracted species is the neutral plutonyl dinitrate at low nitric acid (< 0.8 N) is a mixture of dinitrate and trinitrate at intermediate acidities (0.8-3N), is predominately trinitrate at higher acidities (3-6N), and finally is more complex than trinitrate above 6N.¹⁷¹ At these higher acidities the extraction must involve the solvation of a proton to form the species H(DBC)₂ Pu(NO₃)₃, rather than direct solvation of the Pu in the case of the extraction of the dinitrate species.²⁶⁷ Similarly, Pu(IV) extracts into hexone as Pu(NO₃)₄ from 1.5 M HNO₃ and as H₂Pu(NO₃)₆ at 6 M HNO₃, with intermediate composition of the organic phase in between.^{245, 246} The species extracted into triethyleneglycol dichloride at high nitrate concentration have been found to be H₂Pu(NO₃)₆ for Pu(IV) and H PuO₂(NO₃)₃ for Pu(VI).⁷⁶ Dibutyl ether behaves similarly.⁴¹³

Pu extraction by hexone has received the most attention, undoubtedly because of its use in processing. The extraction of Pu(IV) and Pu(VI) as a function of nitric acid concentration and the concentration of various salts has been measured by several groups.

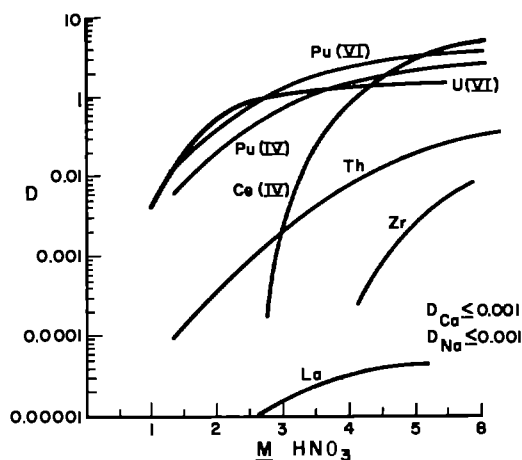

Fig. 30. The distribution ratios of U, Pu(IV) and Pu(VI), Th, Zr, Ce(IV) and La into hexane as functions of the equilibrium concentration of HNO_3 in the aqueous phase.³⁴³ The Ce(IV) curve is taken from Glendenin et al.¹⁴⁷

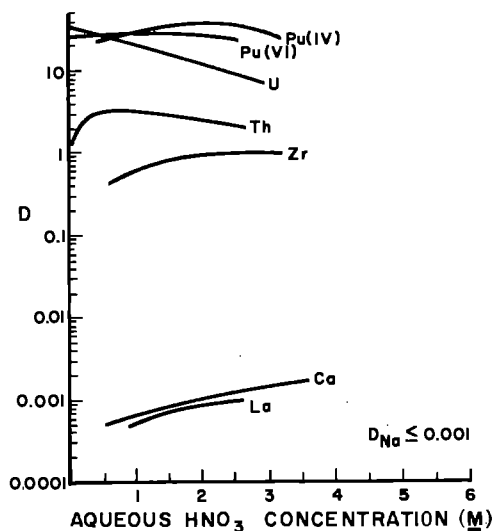

Fig. 31. The distribution ratios of U, Pu(IV) and Pu(VI), Th, Zr, La and Ca into hexane as functions of the equilibrium concentration of HNO_3 in the aqueous phase. Concentration of $\text{Ca}(\text{NO}_3)_2$ 4-3.5 M.³⁴³

Rydberg and Bernström³⁴³ measured distribution coefficients for several elements including U(VI), Pu(IV), and Pu(VI) as a function of nitric acid concentration both with and without calcium nitrate as a salting agent. Typical results are shown in Figs. 30 and 31. The effect of salting with $\text{Ca}(\text{NO}_3)_2$ is to raise all the distribution coefficients, but at low acid those of U and Pu are high enough to be efficiently separated from other elements.

MacKenzie²⁶⁰ extended the distribution curves to higher aqueous acidities for Pu(IV) and Pu(VI) as shown in Fig. 32. This curve was replotted from MacKenzie's original data by Smith³⁸⁸ because the original was reported in terms of organic phase acid concentration. The conversion to aqueous phase original acid concentration was made by using data on nitric acid extraction by hexone. Both Pu(IV) and Pu(VI) pass through maxima and decrease above approximately 7 M acid. A salting agent, e. g. $\text{Al}(\text{NO}_3)_3$,^{271, 153} $\text{Ca}(\text{NO}_3)_2$,³⁴³ NH_4NO_3 ²⁶⁰ increases the distribution coefficient. A useful comparison of various salting agents for Pu(IV) into hexone was reported by Stewart³⁹³ (Fig. 33). The salts increase in salting effectiveness at high total nitrate concentration in this order: ammonium, lanthanum, nitric acid, magnesium, aluminum, and manganese. A similar comparison for Pu(VI) into diethyl ether was made resulting in this order: ammonium, calcium, lanthanum, nitric acid.

Kooi²³⁶ found that the distribution curves for extraction of Pu(IV) and Pu(VI) into hexane did not decrease at high HNO_3 concentrations, in contrast to other workers. His distribution coefficient for Pu(IV) reached the maximum value of approximately 7 at 8 M initial HNO_3

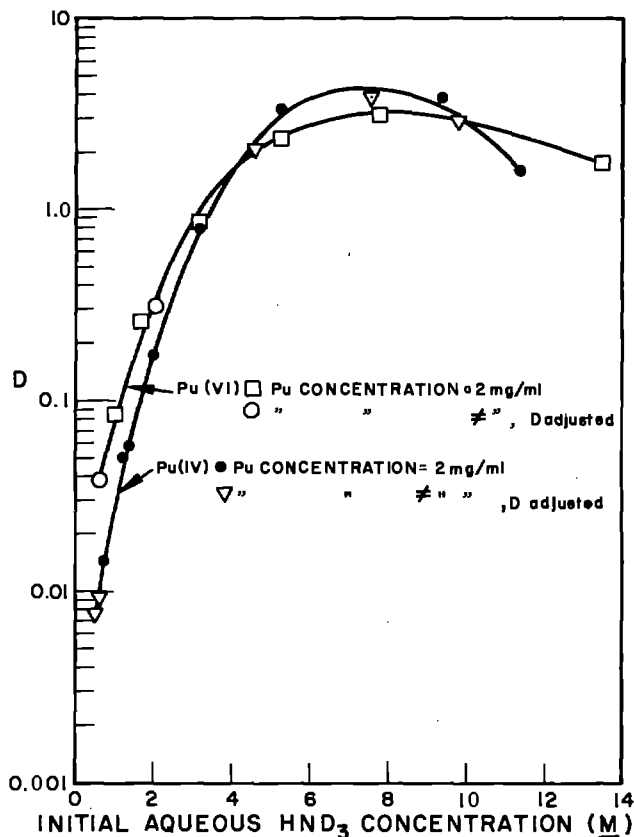

Fig. 32. Distribution of Pu(IV) and Pu(VI) into hexone from HNO₃ solutions.²⁶⁰

concentration. MacKenzie²⁶⁰ found that the distribution coefficient for both Pu(IV) and Pu(VI) in nitric acid increased in the range 0.01-2 mg/ml, while Groot *et al.*¹⁵³ report no dependence on Pu concentration from 0.00003 to 0.5 mg/ml for the extraction of Pu(IV). Groot *et al.*¹⁵³ also find that the distribution coefficients are not affected by either 0.03 M Na₂Cr₂O₇ or 0.3 M sulfonic acid. These reagents are commonly used as oxidizing and reducing agents in redox processes. Rider *et al.*³³² has used hexone in a laboratory procedure to determine Pu and U in reactor targets.

Other Aqueous Systems

Stewart³⁹³ reports on the comparative extraction of Pu (unspecified initial valence) by hexone from hydrochloric, nitric, sulfuric, and acetic acids under various conditions (Table IV-20). Plutonium (presumably a mixture of Pu(IV) and Pu(VI)) extracts well from 8 N HCl, but not from H₂SO₄ or acetic acid, while the extraction is very low under reducing conditions for all these acids.

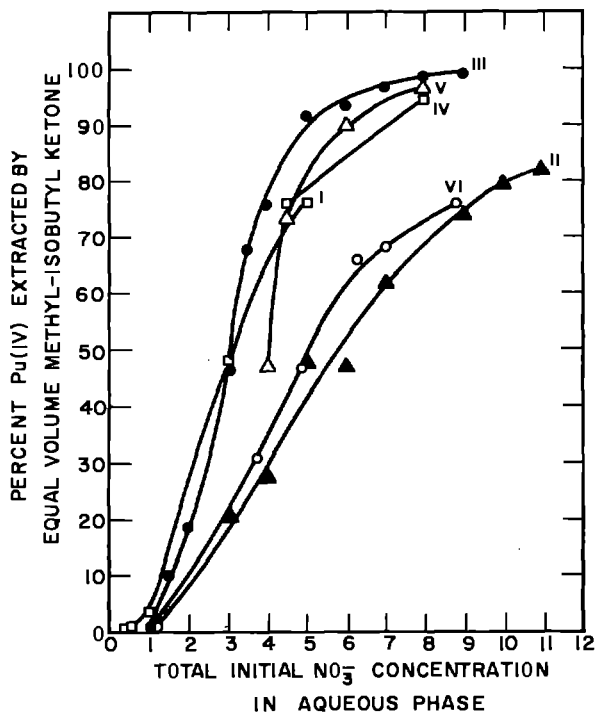

Fig. 33. Effect of total nitrate ion concentration on the extraction of Pu(IV) by methyl isobutyl ketone.³⁹³

Curve No.	Aqueous Phase
I	HNO ₃ only
II	1N HNO ₃ + NH ₄ NO ₃
III	1N HNO ₃ + Mn(NO ₃) ₂
IV	3N HNO ₃ + Mg(NO ₃) ₂ , PO ₄ ----
V	3N HNO ₃ + Al(NO ₃) ₃ , PO ₄ ----
VI	1M HNO ₃ + La(NO ₃) ₃

Other Extractants

Stewart³⁹³ compiled a table of extraction data for a large number of ethers, alcohols, ketones, etc. for Pu in the tri-, quadri- and hexavalent oxidation states from ammonium nitrate-nitric acid mixtures. These data are reproduced in their entirety as Tables IV-21, and IV-22, to show the variety of compounds tried and to indicate the types of compounds which are efficient as Pu extractants. In general, the ability of these compounds to extract correlates with the basicity of the oxygen, nitrogen or other functional group. Thus, electronegative substituents invariably decrease the extractibility of Pu (see e. g. diethyl ether vs dichlorodiethyl-ether).

TABLE IV-20. Distribution of Pu Between Various Aqueous Phases and Hexone.³⁹³

Composition of Aqueous Layer	Distribution Coefficient for Extraction from 8 N Acid			
	HCl	HNO ₃	H ₂ SO ₄	CH ₃ COOH
1. Acid only	10	8.3	0.06	0.012
2. Acid + 0.7 M UO ₂ (NO ₃) ₂ · 6H ₂ O	0.33	3.3	0.005	-----
3. Same, saturated with SO ₂	0.0012	0.25	-----	-----
4. Same, as 2 + 0.06 M hydroquinone	0.0033	----	-----	-----

TABLE IV-21. Extraction of Plutonium from 10 M NH₄NO₃, 1 M HNO₃ by an Equal Volume of Various Organic Solvents. 393

Solvent	% Pu extracted			Solvent	% Pu extracted		
	(III)*	(IV)	(VI)		(III)*	(IV)	(VI)
<u>Ethers-Cellosolves</u>				<u>Acids - Esters</u>			
Diethyl ether	< 1	< 1	50	2-ethyl butyric acid	< 1	5.7	-
N-propyl ether		< 1	4.8(?)	2-ethyl butyl acetate	< 1	1.5	-
Di-isopropyl ether		7	1	<u>Ketones</u>			
Allyl ether		3.4	-	Methyl ethyl ketone			
N-butyl ether		1	1.5	15% Xylene	< 1	79	-
Hexyl ether	< 1	1	1.5	Methyl n-amyl ketone	< 1	52	-
Ethylallyl ether		2	-	Methyl isobutyl ketone			
Ethyl-n-butyl ether		1	6	(Hexone)	< 1	82	-
Dichloro ethyl ether	< 1	3	12	Mesityl oxide		14	-
Phenyl cellosolve		21	-	Acetophenone		89	-
Benzyl cellosolve		48	-	Cyclopentenone		91	-
2-ethyl butyl cellosolve	< 1	71	-	Cyclohexanone		72	-
Diethyl cellosolve		97	96	Methylcyclohexanone		82	-
Ethyl butyl cellosolve		66	73	Menthone		20	47
Dibutyl cellosolve		6	13	Isophorone	< 1	37	-
ββ' Dibutoxyethyl ether		93	91(?)	<u>Hydrocarbons</u>			
Triglycoldichloride	< 1	72	-	Cyclohexane		3	3
Dibutoxytetra-ethylene glycol		73	-	Cyclohexene		5	4
Anisole		3	-	Xylene (mixture of isomers)		10	-
O-Nitroanisole		62	40	Pinene		1.6	-
p-Fluoroanisole		1	-	Indene		5	1
Resorcinildimethyl ether		1	-	<u>Nitro Compounds</u>			
Dimethyldioxane		60(?)	-	Nitroethane		34	61
<u>Sulfur Compounds</u>				Nitromethane	1	58	70
Diethyl sulfide		43	-	Nitro benzene		8	28
Thiophene		1	-	<u>Halogenated Compounds</u>			
Carbon Disulfide		6(?)	1	Methyl Chloroform		4	3.2(?)
<u>Alcohols</u>				Trichloroethylene		6	12
Hexanol		23	-	Chlorobenzene		4	7
Heptanol		15	-	Bromobenzene		2.6	2.5
Heptadecanol	< 1	10	-	Iodobenzene		1.3	1.7
2-ethyl-hexanol	< 1	1	-	o-Bichlorobenzene		4	5
2-ethyl-butanol	< 1	16	-	m-Dichlorobenzene		4.6	-
Methyl-isobutyl carbinol		42	-	Ethyl iodide		1	1
Methyl-amyl alcohol	1	42	-	Isoamyl chloride		1.6	1
				Tertiary amyl chloride		1	-
				<u>Miscellaneous</u>			
				Butyl phosphate		99	97

* (III) Values out of 5 M NH₄ Cl, 1 N HCl, Sat'd. with SO₂.

TABLE IV-22. Extraction of Plutonium into Miscellaneous Organic Solvents.³⁹³

Solvent	Composition of aqueous phase before equilibration	% Pu extracted by equal volume of solvent		
		(III)	(IV)	(VI)
Carbon tetra chloride	Nearly saturated NH_4NO_3		1	1
Ethyl acetate	Nearly saturated LiNO_3		5	25
Chloroform	Nearly saturated LiNO_3		1	1.6
Ethylene dichloride	Nearly saturated KNO_3		1	
Ethyl bromide	Nearly saturated LiNO_3		1.6	2.1
Nitromethane	Nearly saturated LiNO_3		7.9	71
			13	
1-Nitropropane	Nearly saturated LiNO_3		20	81
			30	69
2-Nitropropane	Nearly saturated LiNO_3		39.6	72
Nitroethane	Nearly saturated LiNO_3		72	83
Diethyl cellosolve	20% $\text{UO}_2(\text{NO}_3)_2 \cdot 6\text{H}_2\text{O}$, 10 <u>M</u> NHNO_3 0.5 <u>M</u> HNO_3		84	
Di-butyl cellosolve	2 <u>M</u> HNO_3 , 5 <u>M</u> $\text{Ca}(\text{NO}_3)_2$			11
Di-butyl carbitol	20% $\text{UO}_2(\text{NO}_3)_2 \cdot 6\text{H}_2\text{O}$, 10 <u>M</u> NH_4NO_3 , 1 <u>M</u> HNO_3	0.05	48	8
2-ethyl-butyl cellosolve	20% $\text{UO}_2(\text{NO}_3)_2 \cdot 6\text{H}_2\text{O}$, 10 <u>M</u> NH_4NO_3 , 1 <u>M</u> HNO_3	0.03	46	
Diethyl cellosolve	20% $\text{UO}_2(\text{NO}_3)_2 \cdot 6\text{H}_2\text{O}$, 10 <u>M</u> NH_4NO_3 , 1 <u>M</u> HNO_3	0.3	48	52
Dibutyl cellosolve	20% $\text{UO}_2(\text{NO}_3)_2 \cdot 6\text{H}_2\text{O}$, 10 <u>M</u> NH_4NO_3 , 1 <u>M</u> HNO_3	0.003	3	88
Ethyl butyl cellosolve	20% $\text{UO}_2(\text{NO}_3)_2 \cdot 6\text{H}_2\text{O}$, 10 <u>M</u> NH_4NO_3 , 1 <u>M</u> HNO_3	0.1	60	
Nitromethane	20% $\text{UO}_2(\text{NO}_3)_2 \cdot 6\text{H}_2\text{O}$, 10 <u>M</u> NH_4NO_3 , 1 <u>M</u> HNO_3	5.2	67	
Methyl-isobutyl carbinol	20% $\text{UO}_2(\text{NO}_3)_2 \cdot 6\text{H}_2\text{O}$, 10 <u>M</u> NH_4NO_3 . 1 <u>M</u> HNO_3	0.05	26	
2-ethyl hexoic acid	20% $\text{UO}_2(\text{NO}_3)_2 \cdot 6\text{H}_2\text{O}$, 10 <u>M</u> NH_4NO_3 , 1 <u>M</u> HNO_3	0.03	1	
Methyl isobutyl carbinol acetate	20% $\text{UO}_2(\text{NO}_3)_2 \cdot 6\text{H}_2\text{O}$, 10 <u>M</u> NH_4NO_3 , 1 <u>M</u> HNO_3	0.1	47	
Xylene	3 <u>M</u> HNO_3 , 5 <u>N</u> $\text{Al}(\text{NO}_3)_3$. Dissolved BiPO_4			0.001
Nitrobenzene	3 <u>M</u> HNO_3 , 5 <u>N</u> $\text{Al}(\text{NO}_3)_3$. Dissolved BiPO_4		5	5.3
Nitroethane	3 <u>M</u> HNO_3 , 5 <u>N</u> $\text{Al}(\text{NO}_3)_3$. Dissolved BiPO_4			47.5
Dibutyl carbitol	3 <u>M</u> HNO_3 , 5 <u>N</u> $\text{Al}(\text{NO}_3)_3$. Dissolved BiPO_4			99.8
Ethylene dichloride	2 <u>M</u> HNO_3 , 10 <u>M</u> NH_4NO_3		1	1
Anisole	10 <u>M</u> NH_4NO_3			0.003

Kuca^{245, 246} investigated a series of aliphatic ketones as extractants for Pu(IV). His results, shown in Table IV-23, show that the distribution of Pu(IV) into hexone is decreased by (1) increasing the length of the side chain for the methyl-n-alkyl series, (2) increasing the branching of the side chain for the methyl- (n-, sec-, and tert-) butyl series, and (3) increasing the symmetry for the seven carbon atom series. These results can be qualitatively explained by the effect of the decreased basicity of the carbonyl oxygen as the alkyl side chain is lengthened, and by steric effects in branched alpha carbon atoms. Khalkin et al.²²⁴ found that the distribution coefficient for the extraction of Pu(IV) from 5.0 M HNO₃ was 11.5 by diethyl ether, and this was the highest among a number of oxygen containing compounds. Pu(IV) was extracted as H₂Pu(NO₃)₆ at this acidity. Kooi²³⁶ found that for extraction of Pu(IV) from 8 M HNO₃ the extraction decreased in the order dibutyl carbitol (DBC) > diethyl ether (DEE) > hexone, while for Pu(VI) the order was DBC > hexone > DEE. Branica and Bona⁵⁴ found that U(VI) and Th extract at a lower HNO₃ concentration with several cyclic ethers (e. g.

TABLE IV-23. Distribution Coefficients for Pu(IV) Extracted by Various Ketones from 3.2 M HNO₃.²⁴⁵

Ketone	Distribution coefficient
Methyl-n-propyl	10
Methyl-n-butyl	2.2
Methylisobutyl	1.6
Methyl-t-butyl	0.12
Methyl-n-amyl	0.62
Methyl-n-hexyl	0.22
Di-n-propyl	0.12
Ethyl-n-butyl	0.23

tetrahydropyran) than with diethyl ether or hexone, and these results are presumably applicable to Pu also.

A number of other process applications of this class of extractants are worth mentioning at this point. β, β' -dibutoxydiethylether ("Butex") has been used as one of the extractants, along with TBP in a two-solvent process for purification of Pu and recovery of U at the Windscale power reactor facility.^{450, 188} The quoted advantages over hexone are (1) sufficient resistance to attack by high concentrations of HNO₃ to permit use of the acid as a salting agent, and (2) superior

separation factors of Pu from U. TBP is used as the second extractant because it gives superior decontamination of the Pu from Ru.

Vdovenko and Kovalskaya⁴¹¹ used a mixture of dibutyl ether and carbon tetrachloride in a Redo-type process with satisfactory results.

Dibutoxytetraethylene glycol ("pentaether") has been used as an extractant,¹⁸⁰ along with a 50% pentaether-50% dibutyl ether mixture.²⁸

Siddall^{377, 378} has pioneered the use of N, N disubstituted amides as extractants for tetra- and hexavalent actinides. The carbonyl oxygen in these compounds has enhanced basicity because of the presence of the amido nitrogen, and therefore should be analogous to the neutral organo-phosphorous compounds in extraction properties. Typical results for a number of elements and amides are shown in Fig. 34 and Table IV-24. He found that U(VI) behaved similarly to the phosphorous compounds (e. g. TBP) in that the extracted complex involves two amide molecules. However, the quadrivalent species (Pu, Th, etc.,) are extracted with more than two amides per

TABLE IV-24. Extraction of Actinides and Zirconium by Various N, N-Disubstituted Amides at 3 and 6 M HNO₃ (Ref. 379).^a

Amide ^b	3.0 M HNO ₃ in the aqueous phase						6.0 M HNO ₃ in the aqueous phase					
	U(VI)	Pu(IV)	Pu(VI)	Np(IV)	Np(VI)	HNO ₃	U(VI)	Pu(IV)	Np(IV)	Th	Zr	HNO ₃
N, N-Dihexylformamide	4.1	2.4				0.119	3.6	4.0		0.10	0.54	0.090
N, N-Dibutylacetamide	9.9	21				.138	6.4	38		.74	.21	.102
N, N-Dibutylpropionamide	4.5	3.5				.112	4.5	7.2		.11	.044	.094
N, N-Dibutylisobutyramide	2.4	0.080	0.23	0.024	1.2	.103	3.3	0.21	0.070	.0040	.0026	.083
N, N-Dibutylpivalamide	0.60	0.0009	.051		0.33	.057	1.4	0.0048		.0001	<.001	.060
N, N-Dibutylbutyramide	5.3	4.0	.63	1.0	3.4	.114	4.7	8.7	2.2	.095	.039	.095
N, N-Di-isobutylbutyramide	5.1	3.5	0.48	0.62	3.0	.108	4.8	7.1	1.6	.028	.046	.088
N, N-Di-isobutylisobutyramide	2.0	0.057		0.0070		.100	3.1	0.11	0.037	.0010	0.0012	.085
N, N-Dicyclohexylformamide	9.4	9.9				.150	4.8	11		.21	1.1	.100
N, N-Dicyclohexylacetamide	14	11		2.2		.142	6.3	16		.68	0.026	.091
N, N-Dicyclohexylbutyramide	7.9	1.7				.148	5.1	5.9		.16	.010	.103
N, N-Dibutyl-2-ethylhexanamide	4.0	0.19				.125	4.1	0.29		.0043	.0022	.094
N, N-Dimethyldecanamide	4.9	10				.115	4.4	39		.63	.096	.091
N, N-Diethyldecanamide	5.1	6.9				.120	5.0	16		.34	.049	.096
1-Hexanoylpiperidine	7.2	8.7				.115	5.8	20		.32	.077	.096
1-(2-Ethylhexanoyl)-piperidine	2.8	0.60				.087	4.2	1.5		.025	.011	.080
N, N-Di-sec-butylhexanamide	5.5	.90				.120	4.0	3.9		.092	.0092	.094
N, N-Dibutylcyclohexanecarboxamide	3.1	.19				.103	4.1	1.0		.0040	.0034	.090
N-Butyl-N-phenylbutyramide	1.4	.23				.088	2.4	1.3		.0033	.0099	.085
N, N-Dibutylbenzamide	0.86	.34				.105	1.2	0.69		.0099	.0070	.088
N, N-Dibenzylacetamide	3.3	0.22				0.077	4.3	1.0		0.014	0.021	0.077

^aExtraction coefficient is defined as moles/liter in the organic phase divided by moles/liter in aqueous phase.

^bAll 0.50 M in toluene.

metal atom at high nitrate concentrations. Zr exhibits a maximum distribution coefficient at about 7 M HNO₃ and decreases at higher acidities. A large decrease in the distribution coefficient of quadrivalent Pu and Th occurs as the branching of the alpha carbon atom is increased, while that of U(VI) is only decreased moderately. N, N-dihexyloctanamide was superior to TBP in decontamination of Pu from Zr-Nb, but slightly inferior for Ru decontamination. The potential uses of these compounds are (1) as selective extractants for quadrivalent actinides, or (2) as selective extractants for U(VI) in the case of amides with highly branched alpha carbon atoms (e. g. N, N-dihexyltrialkylacetamide).

Chelating Agents

A large number of bi-functional reagents which form strong coordination complexes with metal ions have been investigated. These complexes are more soluble in non-polar organic solvents such as benzene or carbon tetrachloride than in the aqueous phase, and are therefore extractable. Of these compounds the fluorinated

β -diketone, 2-thenoyltrifluoro acetone (TTA) and the ammonium salt of N-nitrosophenylhydroxylamine ("Cupferron") have been used most widely in radiochemical and analytical applications.

Thenoyltrifluoro acetone (TTA)

This compound has the structural formula

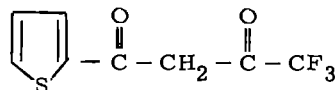

and exists primarily in the enol form in both aqueous and organic solutions.

TTA forms strong complexes with many metal ions, particularly those of high valence. The general reaction for the extraction can be written as

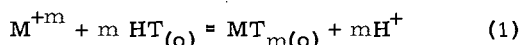

and the equilibrium constant

$$K = \frac{(MT)_{(o)} (H^+)^m}{(M^{+m}) (HT)_{(o)}^m} \quad (2)$$

where the quantities in parentheses are activities.

Thus, if activity coefficients are neglected, and no aqueous complexing occurs, the distribution coefficient should show a direct mth power

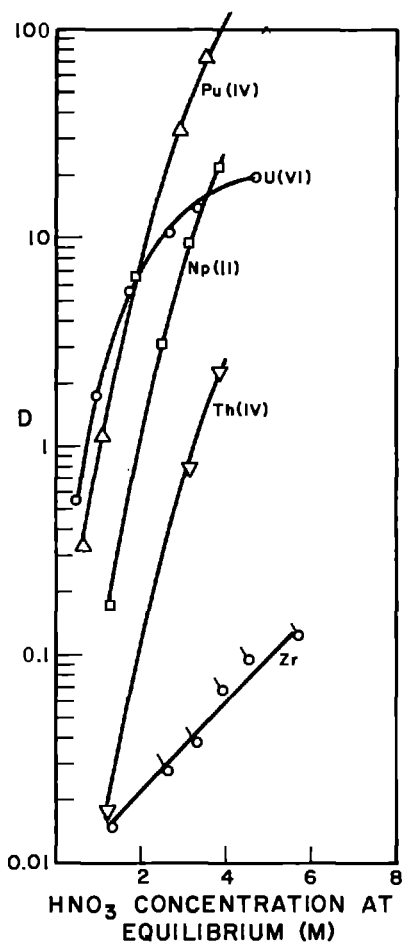

Fig. 34. Extraction of actinides and Zr by 1.09 M N, N-dibutyloctanamide in n-dodecane at 30°. 378

dependence on the TTA concentration and an inverse mth power dependence on the aqueous acidity. This expectation is borne out for many elements, including Pu.

The most comprehensive summary of TTA data is that of Poskanzer and Foreman³²⁴ who found that the extraction data for most elements could be fitted by the equation

$$K = D \frac{[H^+]^x}{(HT)^m f_{HT}^{m-1}} \quad (3)$$

in which K is a constant, $[H^+]$ is the activity of the hydrogen ion in the aqueous phase (HT) is the concentration of the TTA in the organic phase, x is the observed TTA concentration dependence of the reaction, m is that of Eq. 1, and f is the organic phase activity coefficient of the TTA. For benzene solutions of TTA

$$f_{HT} = 1 - 0.24 (HT)^{0.48} \quad (4)$$

Equation (3) assumes that the activity coefficients of the TTA and the metal chelate are equal in the organic phase.

These authors determined the parameters of Eq. (3) for all available experimental data on TTA extractions and calculated pH_{50} , the pH at which 50% of the ion is extracted by equal volume phases into 0.2 M TTA in benzene. They displayed some of these data in the form of a periodic table to show the trends in extractability of the elements (see Fig. 35). In cases in which the pH_{50} value is negative only HCl data are given, while other data may be for a variety of acids and acid-salt combinations. The reader is referred to the original paper for more detail. However, this figure shows that the quadrivalent ions are much more extractable than others.

ELEMENT														B	C	N	O	F
pH ₅₀ OXIDATION STATE														Al III	Si	P	S	Cl
pH ₅₀ • pH OF 50% EXTRACTION WITH EQUAL VOLUME														2.48				
NEGATIVE "pH ₅₀ " • - LOG HCl CONCENTRATION																		
x • COEFFICIENT OF pH DEPENDENCE OF LOG D																		
• OXIDATION STATE WHEN NOT INDICATED																		
Li I >8	Be II 2.33																	
Na	Mg																	
K	Ca II 6.7	Sc III 0.99	Ti	V	Cr	Mn	Fe -0.24 III (4.8) III	Co II 4.7	Ni II >3	Cu II 2.38	Zn	Ga	Ge	As	Se	Br		
Rb	Sr II 7.8	Y III 3.20	Zr IV -1.08	Nb	Mo	Tc	Ru	Rh	Pd	Ag	Cd >8	In III 2.18	Sn	Sb	Te	I		
Cs	Ba II 8.0	La III 4.24	Hf IV 1.0 (3.5)	Ta	W	Re	Os	Ir III >7	Pt	Au	Hg	Tl 5.35 I 2.78 III (1.5) III	Pb II 3.34	Bi III 1.80	Po 0.89 (2)	At		
Fr	Ra II >7	Ac III 4.57 (4.9)																
		Ce 3.88 III	Pr III 3.68	Nd III 3.59	Pm III 3.42	Sm III 3.29	Eu III 3.29	Gd III 3.26	Tb III 3.24	Dy III 3.08	Ho III 3.18	Er	Tm III 3.05	Yb III 2.97	Lu III 2.99			
		Th IV 0.48	Pa -0.94 III (2.2) III	U 1.97 III (1.5) III	Np -0.34 III	Pu 2.29 III (5.5) IV (2) III	Am III 3.22	Cm III 3.4	Bk III 3.0	Cf III 3.7	E III 3.7	Fm III 3.1	Mv	102				

Fig. 35. Extraction of the elements with 0.2 M TTA in benzene.³²⁴

The extraction of Pu(IV) from nitric acid solutions was investigated by Cunninghame and Miles^{110, 111} using CCl₄ and benzene as solvents primarily, although other chlorinated hydrocarbons were used also. They find that, by neglecting aqueous phase nitrate complexing of the Pu, the equilibrium can be expressed by the equation

$$C = D_{\text{Pu(IV)}} \frac{A_{\text{HNO}_3}^4}{(\text{HT})^4} \frac{f_{\text{PuT}_4}}{f_{\text{HT}}^4} \quad (5)$$

They derive the f 's from the TTA concentration dependence of the distribution coefficient, and find that C is close to $1 \times 10^{+5}$ over the range from 1 to 10 \underline{M} HNO₃ for tracer Pu. Heisig and Hicks,¹⁷³ in a very extensive study of the kinetics of the extraction of Pu(IV) from nitric acid solutions by TTA in sec-butyl benzene, determined that the rate of transfer of Pu chelate across the organic aqueous boundary controls the forward and reductive back extraction rates. They find that at low nitric acid concentrations (0.5 \underline{M}) the extracted species is PuT₄, while at 4.9 \underline{M} total nitrate concentration some partially nitrated complex such as PuNO₃T₃ exists.

Heisig and Hicks¹⁷⁴ found that for Pu(VI) extractions into TTA-benzene from nitric acid solutions the dependencies are direct second-power on the TTA concentration and inverse second-power on the hydrogen ion concentration, indicating that Eq. (1) represents the reaction. These authors measured the distribution coefficients for the Pu(III) obtained by reduction with 0.005 \underline{M} ferrous perchlorate - 0.01 \underline{M} sulfuric acid as a function of nitric acid and TTA concentrations. They obtained a direct 2.3 power dependency on TTA concentration and an inverse 2.6 power dependency on hydrogen ion. These solutions were never stabilized in the presence of TTA, however. Since the distribution coefficient increased with time, extrapolations to time zero were made, and the extrapolated values were used. Plots of the distribution coefficients for Pu(III) and Pu(VI) obtained by Heisig and Hicks are shown in Fig. 36.

Cunninghame and Miles¹¹¹ determined the extraction properties of a number of possible impurities in the development of a batch process for separating Pu from irradiated U. Their results are shown in Fig. 37. Their procedure, which should be easily adaptable to the laboratory scale, is to pre-extract the Zr from 0.5 \underline{M} HNO₃ while the Pu is reduced to Pu(III) with hydroxylamine, oxidize to Pu(IV) with NaNO₂, extract with 0.2 \underline{M} TTA-benzene, scrub with dilute HNO₃, and back-extract the Pu into 8 \underline{M} HNO₃. They report a 99.4% Pu recovery on a 1-gram scale with decontamination factors from Zr and U of 3000 and 667, respectively.

Other reports on the use of TTA for processing irradiated uranium for Pu are those of Crandall *et al.*¹⁰⁵ and Culler.¹⁰⁹ An interesting variation is the use of U(IV) to strip Pu from TTA solutions by reduction to Pu(III) or a combination of reduction and displacement.³⁴² The application of TTA to analytical and radiochemical procedures for Pu has been reported many times, either as the only purification step^{287, 50, 356} for rapid analysis (see for example, Procedure 2, Section VIII) or in combination with co-precipitation steps involving LaF₃,^{136, 351, 50, 284} BiPO₄,^{341, 237} chemisorption on a CaF₂ suspension,³⁵² or other separation steps.^{332, 315, 168, 261}

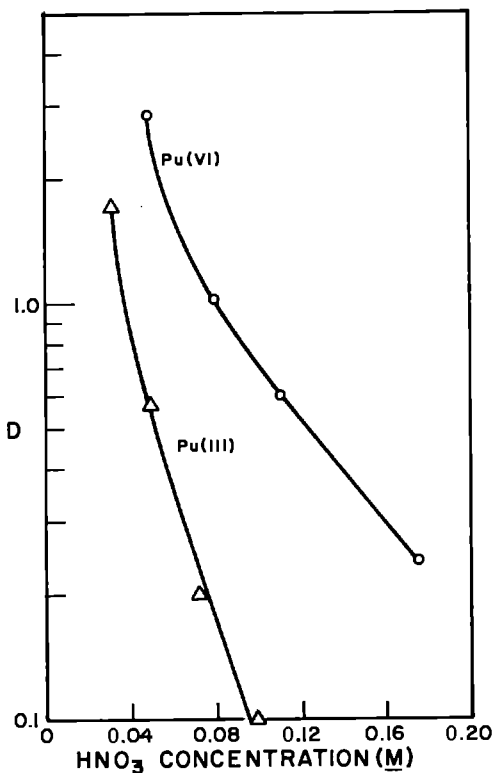

Fig. 36. Extraction of Pu(III) and Pu(VI) into TTA-benzene as a function of HNO₃ concentration at constant total nitrate concentration. LiNO₃ added.¹⁷⁴

	Pu(VI)	Pu(III)
TTA conc. (M)	0.74	1.65
Total nitrate (M)	0.175	0.096
Aqueous conditions	0.005 M	0.005 M
	2 × 10 ⁻⁴ M KMnO ₄	Fe(ClO ₄) ₂

and Pu(VI) are extracted together. On a second sample, the Pu(IV) and Pu(III) are coprecipitated together with LaF₃. The relative amounts of the three valence states are then calculated by difference.

TTA has been used to separate Pu from impurities for a spectrographic analysis.⁴¹¹ In this procedure an HCl solution of the metal is reduced to Pu(III) with hydroxylamine and impurity elements extracted with TTA in hexone. The Pu in the aqueous phase is then oxidized to Pu(IV) and extracted into TTA-hexone. By this procedure both extractable and non-extractable impurities can be determined.

TTA has been used for several procedures for the determination of Pu in biological material, especially urine^{125, 349, 360, 257, 56, 316} (see, for example, Procedure 21, Section VIII).

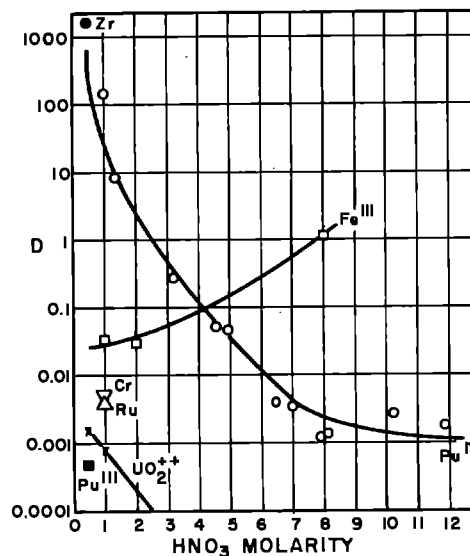

Fig. 37. Distribution coefficients of various ions from nitric acid solutions into 0.2 M TTA in benzene.^{110, 111}

TTA has been used to separate a small amount of U from macro Pu,¹⁹⁴ or vice versa,⁴¹⁵ to concentrate Pu from environmental water samples³⁵² and to determine the oxidation state of Pu in environmental samples, including sea water.¹³⁶ In the latter procedure, Pu(IV) is extracted from 0.5 M HCl and the aqueous raffinate adjusted to pH 4.3 with ammonium acetate from which the Pu(III)

Cupferron

N-nitrosophenylhydroxylamine or cupferron has been used as a precipitating agent for many metal ions for many years, and the solubility of these complexes in non-polar solvents such as chloroform was recognized at an early date. The extraction reaction is analogous to Eq. 1, although little quantitative work has been done on Pu. Furman *et al.*¹³⁸ have reviewed the subject and have given data for U(IV) and U(VI). Kemp²²⁰ found that Pu(III) required four cupferron molecules per Pu atom in extractions into chloroform from HCl-ammonium chloride solutions ($\mu = 1.0$ pH = 4.5 - 5). He ruled out oxidation of the Pu(III) by the reagent and postulated an "extra" cupferron molecule in the organic phase to complete the eightfold coordination sphere. The pH dependence for Pu(III) from these solutions was found to be third power, in accordance with Eq. 1. The pH dependence of Pu(III) with and without the presence of hydroxylamine and Pu(IV) is shown in Fig. 38.

Kirk and Rodden²²⁹ report that most light elements are not extracted by cupferron- CHCl_3 and listed Fe, U(VI), U(IV), and Pu(IV) as extractable species. They report low extraction for Pu(VI), but essentially complete extraction for Pu(III) and Pu(IV). The extraction of reduced Pu is lowered above pH 0.8 in H_2SO_4 . Phosphate interferes with the extraction, but a small concentration of iron is beneficial.

Nigon and Penneman³⁰⁴ report a separation of Pu and Am, based on extraction of the Pu in the presence of ferrous ammonium sulfate from 1 N HCl solutions. The fact

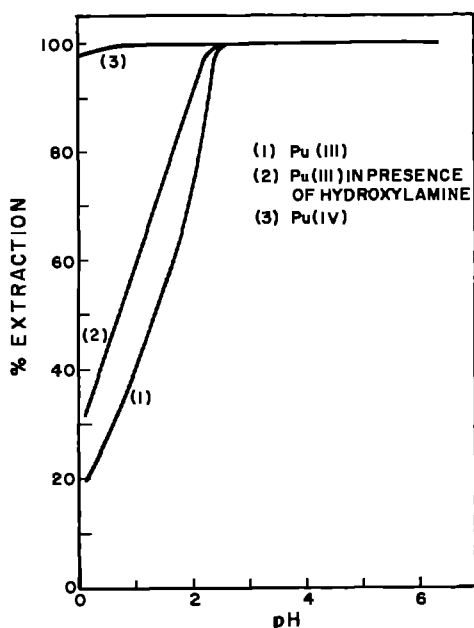

Fig. 38. Extraction of Pu(III) and Pu(IV) from 1.0 M chloride into cupferron- CHCl_3 .²²⁰ Curve 1: Pu(III) = 2.16×10^{-3} M, cupferron = 3.98×10^{-2} M; Curve 2: Pu(III) = 3.65×10^{-3} M; cupferron = 3.68×10^{-2} M, 10 w/v% hydroxylamine hydrochloride. The curves are % extraction for equal phase volumes vs equilibrium pH.

that the extraction rate of Pu is slowed by cooling from room temperature to 5°C suggests that oxidation from Pu(III) to Pu(IV) is taking place in the presence of cupferron. They report a separation factor of 10^5 with quantitative recovery of both Am and Pu. A similar procedure has been used to separate Pu from U.⁴¹⁷

Kooi and Hallatein²³⁷ has used cupferron extractions to concentrate Pu from environmental water samples. Beaufait and Lukens³⁷ incorporated a cupferron extraction step in a general radiochemical procedure for Pu.

Cupferron has been used in several procedures to separate Pu before spectrographic determination of impurity elements.^{296, 45}

Finally, cupferron, has been widely used in procedures to separate and concentrate Pu from biological materials.^{102, 387, 248, 272}



Chmutova *et al.*⁸⁷ developed a procedure for determination of Pu by extraction from 3 M HNO_3 by a chloroform solution of N-benzoylphenylhydroxylamine (BPHA), an analog of

cupferron, followed by back extraction of the Pu(IV) into sulfuric acid. It was found that U, Am, Np(V), and fission products (except Nb and Zr) do not extract under these conditions. The Nb and Zr are separated in the back extraction step.

Other Chelating Compounds

Many organic chelating agents were investigated in the Manhattan Project for possible extractants for Pu, including acetylacetone, trifluoroacetylacetone, and various other fluorinated diketones. Stewart³⁹³ has compiled extraction data for such compounds as well as many other complexing agents. Extraction data for several chelating agents are shown in Table IV-25.

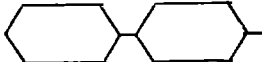
TABLE IV-25. Comparison of the Extractability of Plutonium into Benzene Phases Containing Various Fluorinated Diketones.³⁹³

Code name	Substituted group R ₁ (a)	Pu(IV) distribution ratio $\frac{\text{benzene}}{0.5 \text{ N HNO}_3}$	Relative concentration needed to give same extraction of Pu(IV)
TFA	CH ₃	1.0	1
PTA	CH ₃ CH ₂	9.0	1/3
ITA	(CH ₃) ₂ CHCH ₂	~100	1/5
BTA	C ₆ H ₅	~100	1/7
TTA	$\begin{array}{c} \text{HC} - \text{CH} \\ \quad \\ \text{HC} \quad \text{C} - \\ \quad \quad \text{S} \end{array}$	42	1/15
FBTA	pFC ₆ H ₄	~100	1/7
PBTA		~100	1/7
NTA		~100	1/7
FTA	$\begin{array}{c} \text{CH} - \text{CH} \\ \quad \\ \text{HC} \quad \text{C} - \\ \quad \quad \text{O} \end{array}$	~100	1

(a) The general formula for these compounds is R₁-C(O)CH₂C(O)CF₃.

Pu(VI) and Pu(IV) complexes with pyridine-N-oxide-2-carboxylic acid which precipitate at pH 2-3 have been prepared.¹⁷⁶ These compounds are iso-structural with TTA complex. A possible application is the separation of U(VI) and Pu(VI) from solutions of salts.

Mixed Extractants

Synergism

The term synergism is used to denote enhanced (or depressed) extraction of metals by mixed extractants, as against the extraction by each extractant taken separately. This subject has received considerable attention in recent years. Pu has received its share (perhaps more than its share) of the general research, and while not many radiochemical applications have appeared for this phenomenon, it is to be expected that more will be found. Considered in this section are all cases of changed extraction properties due to changes in the nature of the supposedly inert diluent, as well as mixtures of different types of extractants such as TBP-TTA, TBP-DBP, etc. The range of phenomena described under the term synergism is thus diverse, complex, and in general not completely understood. The review of Marcus²⁶⁷ is excellent in this regard, and the reader is referred to it for a more complete discussion.

Influence of Diluent

Taube^{396, 397, 398} conducted extensive studies on the effect of the polarity and polarizability of supposedly inert diluents on the extractability of tetra- and hexavalent actinides with various extractants, including hexone, TBP, DBC, TTA, TLA, and TBAN. Examples of diluents used are polar (P): chloroform, non-polar (L): carbon tetrachloride, non-polar but polarizable (H): benzene. He found that the nature of the diluent exerted a large influence on the extractability, and proposed a theory based on (1) the interaction between the dipole of the organic molecule and the diluent dipoles, and (2) mutual interaction between permanent dipoles in the diluent mixture giving rise to structure in the organic phase. The effects can be large; e. g., $D_{Pu(IV)}$ increases a factor of three in going from pure $CHCl_3$ to pure benzene in TBP extractions. In general, the extraction of a non-polar complex (Pu(IV) and Pu(VI) with hexone, TBP, TTA, etc.) is favored by a non-polar diluent. In the case of the highly polar Pu(IV)-TBAN complex, the extraction is favored by a polar diluent; however, the presence of a polarizable diluent increases the extraction. The extraction as a function of the mole fraction of H-type diluent thus exhibits a maximum. This is explained by disruption of the association of the dipoles in the P-type diluent, followed by participation of the induced dipoles in the H-type diluent in the extraction.

Shevchenko *et al.*^{369, 371} found that the extractability of U(VI), Pu(IV), Zr(IV), and Ce(III) decrease with increasing polarizability of the diluent by TBP solutions from 3 M HNO_3 .

Far greater effects are observed when two different classes of extractants are mixed. The enhancement (or depression) of the distribution coefficients may be 10^4 or

more. Siekierski and Taube,³⁸¹ and Taube⁴⁰⁰ have proposed a system for synergistic mixtures based on classification of extractors as anionic (A^-), neutral (B^0), or cationic (C^+). Anionic extractants are acidic compounds such as TTA, DBP, HDEHP, etc. that act as organic anions in the extracted complex; similarly neutral extractants (TBP, TOPO, etc.) are neutral compounds that form complexes through a basic oxygen atom, and cationic extractants are strongly basic compounds (TOA, TBAN, etc.) that act as cations in the extracted complex. In general the synergistic effect is small in mixtures of compounds of the same class, and may be small or large in mixtures of different classes. These authors define a synergistic coefficient as

$$S = \log \frac{D_{1,2, \text{exp}}}{D_{1,2, \text{add}}} \quad (1)$$

$D_{1,2, \text{exp}}$ is the experimental distribution coefficient of a mixture of extractants 1 and 2, and $D_{1,2, \text{add}}$ is the calculated distribution coefficient based on additivity of the individual distribution coefficients. Additivity is based on the assumption that (1) no interaction between the extractants occurs, and (2) no mixed complex of the extracted metal ion with the two extractants occurs. Both assumptions are commonly not true when extractants of different types are mixed. A summary table of examples of synergistic mixtures for U and Pu extraction is given in Table IV-26, based on this classification system. Taube⁴⁰⁰ has made an extensive survey of mixed extraction systems.

Synergism in the system M-TTA-P, where M is an actinide and P is a neutral phosphate compound has been studied by Irving and Edgington,¹⁹⁶⁻²⁰⁰ in nitric acid and Healy¹⁶⁹ in HCl. Healy found no evidence of participation of chloride in the extraction. The extraction reaction is thus

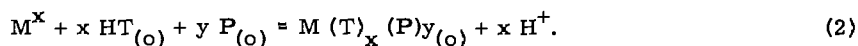

Values of y ranged from 1 to 3 for various di-, tri-, and hexavalent ions. Th(IV) had a y value of 1 as did UO_2^{++} , except in the case of TOPO where a value of 3 was also obtained at high P concentrations.

Irving and Edgington found that 1 or 2 nitrates could enter into the complex, depending on the nitric acid concentration. With tributyl phosphine oxide (TBPO) the species identified were $M(IV) T_3(NO_3)_1 P_1$, $M(IV) T_2(NO_3)_2 P_2$, and $M(III) T_2(NO_3)_2 P_2$, whereas with P = TBP they were $M(III) T_3 P_2$, $M(IV) T_3(NO_3)_1 P_1$, and $M(VI) T_2 P_1$, where M is an actinide. Thus the complex is influenced by the basic strength of P. These authors postulate that the reaction mechanism for hexavalent species is the replacement of a water molecule in the complex by P, giving a coordinately unsaturated product, thus

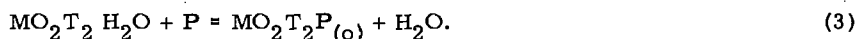

In the case of tetravalent species, one or more chelates are displaced by P molecules, with nitrates added to preserve electrical neutrality, thus

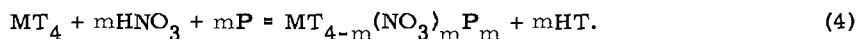
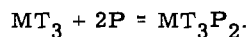

TABLE IV-26. Synergistic and Antagonistic Effects in Two Extractant Systems in U and Pu Extractions.³⁸¹

System	Synergism or antagonism occurs	Examples for plutonium and uranium extraction	References and remarks
$A_1^- + A_2^-$ anionic + anionic	$S > 0$?	
	$S \ll 0$	U(VI), $HG_2PO + H_2GPO$	Blake, 1959 ⁵⁹
$A^- + B^0$ anionic + non-ionic	$S \gg 0$	U(VI), H_2SO_4 , D2EHPO + TBPO U(VI), HNO_3 , TTA + TBP Pu(VI), HNO_3 , HDEHP + TBPO Pu(VI), H_2SO_4 , DNNSA + TBP Pu(VI), HNO_3 , TTA + TBP	Blake, 1959 ⁵⁹ Irving, 1960 ¹⁹⁶ Blake, 1959 ⁵⁹ Oak Ridge, 1960 ⁴⁴³ Irving, 1961 ¹⁹⁸ Taube, 1961 ⁴⁰⁰
	$S \ll 0$	U(VI), H_2SO_4 DDPA + TBP Pu(VI), Pu(IV), H_2SO_4 , DBP + TBP	Blake, 1959 ⁵⁹ Taube, 1961 ⁴⁰⁰
$A^- + C^+$ anionic + cationic	$S \gg 0$	U(VI), H_2SO_4 , DBP + TOA U(VI), HDEHP + tertiary amines Pu(VI) H_2SO_4 , DBP + TOA	Deptula, Minc 1961 ¹¹⁵ Blake, 1959 ²⁸ Taube, 1961 ⁴⁰⁰
	$S < 0$	Pu(IV), H_2SO_4 , DBP + TBAN	Taube, 1961 ⁴⁰⁰
$B_1^0 + B_2^0$ non-ionic + non-ionic	$S > 0$	U(VI), TBP, TiBP	
	$S < 0$?	Siddal 1960 ³⁷⁶ no data
$B^0 + C^+$ non-ionic + cationic	$S \sim 0$	Pu(VI), Pu(IV), HNO_3 , TBP + TOA Pu(VI), Pu(IV), HNO_3 , TBP + TBAN	Taube, 1961 ⁴⁰⁰ Taube, 1961 ⁴⁰⁰
$C_1^+ + C_2^+$ cationic + cationic	$S \sim 0$	Pu(IV), HNO_3 , TOA + TBAN	Taube, 1961 ⁴⁰⁰
SYMBOLS	G* general alkyl group D2EHPO di-2-ethylhexyl phosphine oxide TBPO tri-n-butyl phosphine oxide DNNSA dinonylnaphthalenesulfonic acid TBAN tetrabutyl ammonium nitrate TiBP triisobutyl phosphate		

The trivalent species are considered to become 8-coordinated by either addition of two P molecules or replacement of two water molecules. The addition reaction is



The synergistic effects discussed so far are for relatively small concentrations of P. If the P concentration is increased to about 1 M and above, a strong negative-synergism or antagonism sets in. The P dependencies for several M/TTA/P/HCl systems as quoted by Healy¹⁶⁹ are shown in Table IV-27. Thus it is possible by judicious addition of one of these compounds to effect the selective return of ions to the aqueous phase.

TABLE IV-27. Slope of the Dependence of the Distribution Coefficient on the Concentration of the Added Reagent for Mixtures of Phosphorous Esters, Amides, Alcohols and Ketones with TTA.⁴¹

Ion	Valence	Synergism region	Antisynergism region
Th	IV	+1	-2
Am, Pm	III	+2	-4
UO ₂	VI	+1	-2

Fused Salt Systems

Some research has been done on the solvent extraction properties of actinide and other elements in relatively low-temperature eutectic mixtures of fused salts because of their potential use in homogeneous power reactors. Gruen *et al.*¹⁵⁴ give a general discussion of oxidation states and spectra of actinides in LiNO₃-KNO₃ mixtures, and indicate that TBP extracts a number of elements efficiently from the eutectic mixture. Isaac *et al.*²⁰¹ determined the distribution coefficients between Co(II), M(III) (where M is a trivalent actinide or lanthanide), Np(V) and Np(VI), and U(VI) in this eutectic mixture (MP 120°C) and dilute solutions of TBP in a mixture of polyphenyls at 150°C. In general, the distribution coefficients were a factor of 10² or 10³ higher than the corresponding concentrated aqueous nitrate solutions. The distribution coefficients all showed the same TBP concentration dependency as in aqueous solutions, indicating that the extraction mechanism is the same, the higher distribution being due to the increased salting-in effect. The effect of added chloride was to lower the distribution coefficients. Quadrivalent actinides would be expected to behave similarly, although none was determined.

Borkowska *et al.*⁵¹ used a KCl-CuCl eutectic mixture at 180° to study the extraction of Pu, U, and Am by solutions of TBP, TOA, and HDBP in diphenyl. For TOA they find the extractability is in the order

$$D_{\text{Pu(III)}} < D_{\text{Am(III)}} < D_{\text{U(III)}} \ll D_{\text{U(IV)}}$$

In this system a maximum in the D vs concentration of TOA curve occurs at ~40% TOA, where $D_{\text{U(IV)}} \sim 3$. TBP shows similar behavior. The maximum in this case is at 67% TBP, where $D_{\text{U(IV)}} \sim 50$. For U_(IV), HDBP is similar to TBP.

Moore²⁸⁹ measured the distribution of a number of ions between the immiscible salt pair LiCl-AlCl₄⁻K⁺ at 650°C. It is perhaps not proper to speak of this system as extraction; however significant distributions (Kd > 1 on a mole fraction basis) in favor of the LiCl phase were noted for UCl₄ (for which SnCl₂ was added as a reductant), PuCl₄, and FeCl₃. The ratio of the distribution coefficients for tri- and tetravalent actinides was > 40. Since the SnCl₂ used to stabilize the U(IV) also reduced Pu to the trivalent state, an easy separation is possible in this system. Similar results were obtained by Moore and Lyon²⁹⁰ for the system KCl-AlCl₃-Al. In this case the separation factor for U from Pu and Th is approximately 100, while that for Th from Pa is up to 800.

Cafasso *et al.*⁷³ determined the partition coefficient of a number of elements, including U and Pu, between liquid lead and zinc at 703°C. The results (Zn/Pb) are Pd:600, U:21.5, Pu:7.3, Ce:3.4, Sr:0.05.

D.3 Ion Exchange

The phenomenon of ion exchange is of great utility in the radiochemical separation of Pu. Cationic Pu in dilute, non-complexing, acid solution will readily adsorb on cation resin in the hydrogen or alkali metal form. On the other hand Pu(IV) and Pu(VI) form anionic complexes in moderately concentrated nitric or hydrochloric acids and so will adsorb on anion exchange resins. Anion and cation exchange methods are thus both usable to separate Pu. The anion exchange separation is especially valuable in the laboratory because of the simple equipment required, the ease of manipulation, and the excellent decontamination from fission products by the use of redox cycles.

Recently synthetic inorganic cation exchangers such as zirconium phosphate have been developed.

A good introduction to the subject of ion exchange in the actinides is contained in Chapter 7 of Seaborg and Katz.¹ The review of Hyde¹⁷ is valuable for ion exchange separations of the actinides. The general subject of ion exchange has been reviewed many times. The books of Helfferich¹⁷⁵ and Samuelson³⁴⁸ are good references to the theory and applications of ion exchangers. Samuelson has a good review of recent work done on actinides. Helfferich gives a table of the names and properties of commercially available ion-exchange materials. Kraus and Nelson²⁴¹ reviewed the general subject of ion-exchange separations in 1957, while Hardy¹⁶² reviewed the ion exchange data for actinides in 1958.

Cation Exchange

The general cation exchange reaction for an exchanger in the hydrogen form (acid solution) is



In this equation R is an exchanger site. The exchange reaction is favored by a low acid concentration or conversely, high acid can be used to displace the metal from the exchanger by mass action. Another way to remove metal ions from the exchanger is to decrease the concentration of M^{+b} by complexing. In general, the absorbability of cations on ion exchangers increases with increasing charge and decreasing hydrated radius. Thus, the order of absorbability on cation exchangers for Pu is Pu(IV) > Pu(III) > Pu(VI). For example, Schubert³⁵⁸ found the following adsorption affinity for the strong base cation resin Amberlite IR-1: Th(IV) > Pu(IV) > La(III) Rare Earths > Y(III) Rare Earths > Ba(II) > Cs(I) > Sr(II) > UO_2^{++} . All Pu species are absorbed well at low acid concentration, and are desorbed at high acid concentrations. However, many anions form neutral or anionic complexes with Pu in all of its oxidation states, and therefore Pu may be desorbed by reaction with the anion of the acid, as well as the mass action displacement.

The sulfonated cross-linked polystyrene resins have been by far the most popular materials for the separation of inorganic species, including the actinides. Typical of these is Dowex-50. This resin is usually specified as "X 4" or "X 12," etc., which means 4% or 12%, etc. divinylbenzene was added to the styrene in the

polymerization of the resin to provide the cross linkage. In general, the low-cross-linked resins have the advantage of faster kinetics, but also have the disadvantage of greater volume change with changing ionic milieu.

As mentioned above, under non-complexing conditions, i. e., dilute acidic solution, the absorption of Pu is essentially independent of the anions present. However, many anions form Pu complexes at moderate concentrations, which makes the elution behavior of Pu variable.

The elution behavior of Pu on cation resin is summarized in Fig. 39, where the distribution coefficient for Pu(III), Pu(IV), and Pu(VI) on Dowex-50 is plotted as a function of the acid molarity.

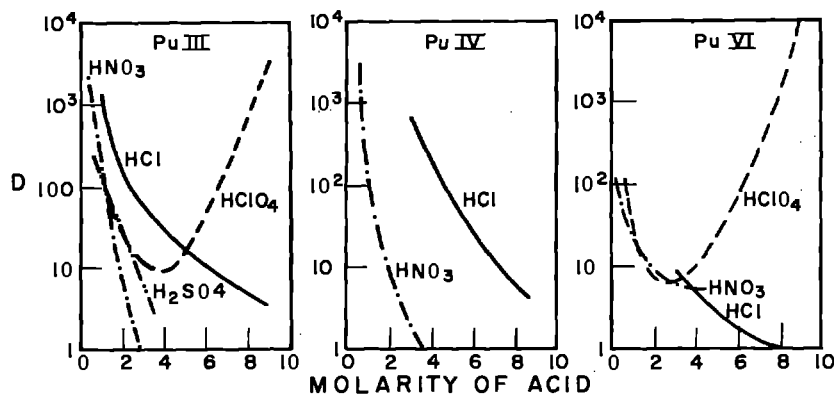

Fig. 39. Typical distribution coefficients of Pu on Dowex 50 in common acidic solutions.

These data are intended to be only illustrative of the behavior of Pu. In some cases, the data of other actinides (e. g. Am(III), U(VI)) were adjusted to correspond to Pu in the same valance state. The data in every case were taken from literature mentioned later in this section.

In general, the slopes of the curves are steeper for HNO_3 , H_2SO_4 , and HClO_4 than for HCl . A strong increase in the distribution coefficient in HClO_4 at high acidities is shown for Pu(III) and Pu(VI). This increase occurs in a great number of elements,³⁰⁰ and probably also for Pu(IV).

The classic work on cation exchange of the actinide elements in HCl solution was done by Diamond *et al.*¹¹⁷ whose principal results are shown in Fig. 40 as a plot of relative volumes required to elute tracer amounts of the ions from a Dowex-50 column 10 cm long by 1 or 1.5 mm in diameter. These data are proportional to the distribution coefficients, and illustrate the separations obtainable in this system. The points for the Pu species have been connected to make a crude elution position vs HCl concentration plot. The extreme decrease of the Pu(IV) elution position in going from 3.2 to 9.3 M HCl is undoubtedly due to the formation of an anionic chloride complex. The tetravalent actinides elute in this sequence: Pu, Np, U, Th; i. e., Th has the highest distribution coefficient at any HCl concentration. This order of elution is in accord with the decreasing hydrated radii in going from Pu to Th. Th(IV) was not

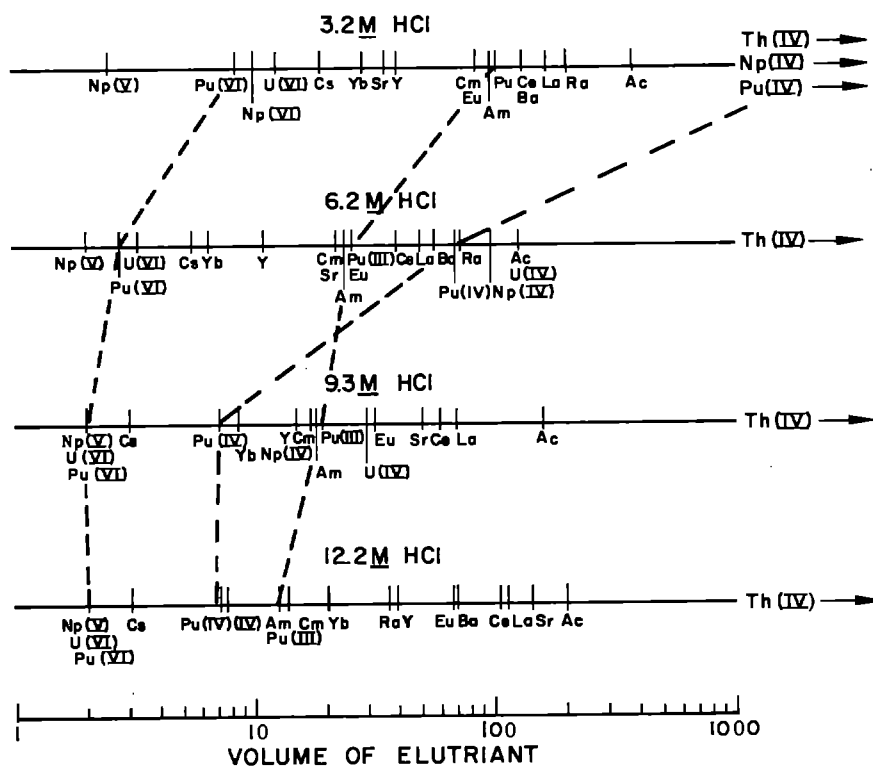

Fig. 40. Relative elution peak position of actinides and other ions in various HCl concentrations. The positions of the Pu ions have been connected by lines.¹¹⁷

eluted at all under the conditions of the experiment. A plot of the elution position of the tetravalent actinides under slightly different conditions is shown in Fig. 41 to show the relative elution position of Th(IV). The well-known separation of the trivalent actinides and lanthanides is illustrated by the increase in the elution positions of the lanthanides at high acidities.

Nelson *et al.*³⁰⁰ summarized the cation exchange behavior of most of the elements in HCl. The summary is in Fig. 42 as a periodic table of D_V vs HCl concentration. Dowex-50 \times 4 resin was used. Although relatively few data for Pu are included, the curves for Th(IV), U(VI), and Am(III) permit a normalization to the data of Diamond *et al.*¹¹⁷

Strelow³⁹⁵ investigated the cation exchange behavior of 43 elements on Dowex-50 \times 8 resin at HCl concentrations up to 4 M with results in general agreement with those above. He arranged the elements in decreasing order of the equilibrium distribution coefficients in 1 M HCl. The values ranged from 7250 for Zr(IV) to 0.3 for Hg⁺⁺. The distribution coefficient of Th(IV), the only actinide studied, was 2049, just below Zr.

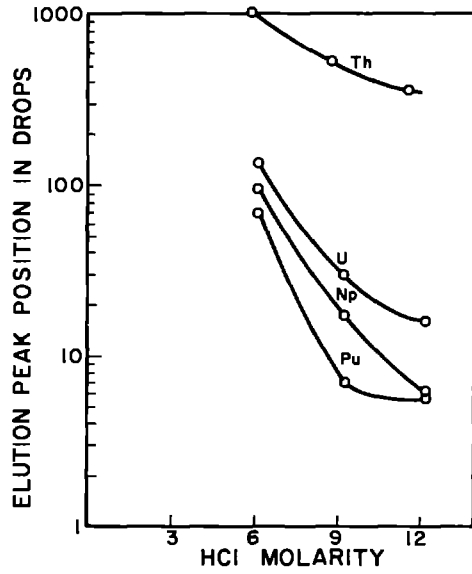

Fig. 41. Elution peak position of the tetrapositive ions vs hydrochloric acid molarity.¹¹⁷

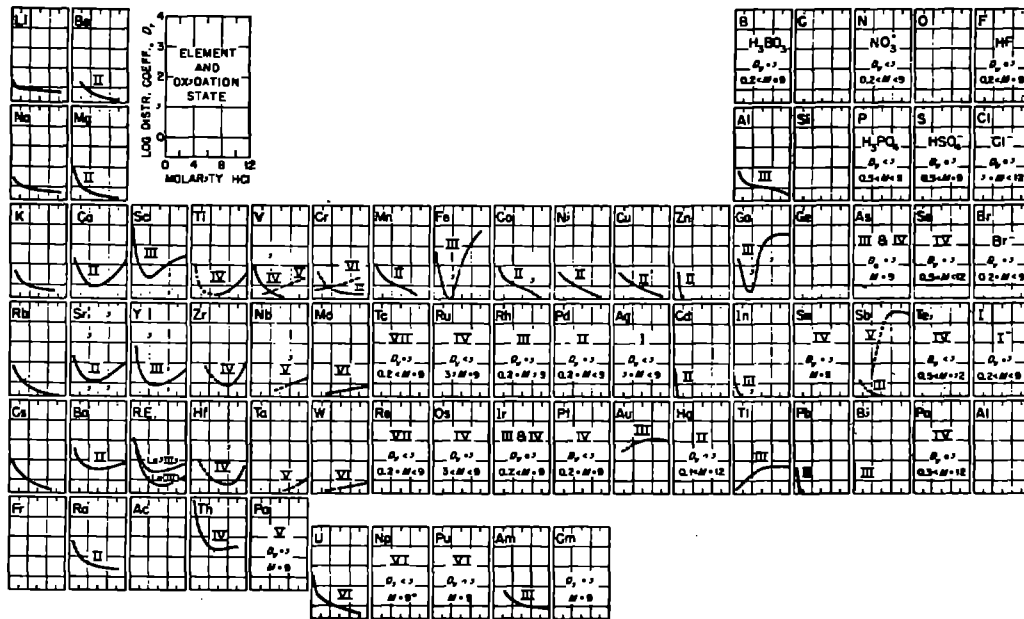

Fig. 42. Volume distribution coefficient of the elements vs HCl concentration for Dowex 50 X 4 cation exchange resin. Tracer concentrations of the elements were used for the most part.³⁰⁰

Prevot *et al.*³²⁵ determined coefficients of Pu(III) and Pu(IV), along with other ions as a function of HNO₃ concentration (Fig. 43). They used C-50 resin (similar to Dowex-50). Pu(III) and Pu(IV) are expected to adsorb very strongly below 1 M acid. The distribution coefficient is very low at HNO₃ concentrations ≤ 4 M, since the U(VI) and Fe(III) curves are flattening out. A partial separation from these ions can be achieved in the elution of the Pu.

Nelson *et al.*³⁰⁰ also used HClO₄ as the aqueous medium in their survey of cation exchange behavior. The results shown in Fig. 44 show some striking differences from the HCl data. In high HClO₄ concentrations (> 9 M) most elements have increasing distribution coefficients after having gone through minima. These authors state that essentially all the actinides in whatever oxidation state have appreciable distribution coefficients at high HClO₄ concentration, and that this phenomenon might be made the basis of an actinide group separation.

Neill and Higgins²⁹⁹ determined distribution coefficients for Pu(III) and Pu(IV) for several resins in sulfuric acid solutions. Their results are shown in Table IV-28. They used Dowex-50 resin to demonstrate a process for recovering Pu from sulfuric acid deplating solutions which contain stainless steel. The Pu is normally trivalent in dilute sulfuric acid solutions, and is adsorbed from 0.5 M acid, scrubbed with 0.5 M sulfuric acid, washed with water to remove sulfate, and eluted with 6 N HNO₃. The product Pu solution contained 5% of the original stainless steel materials, primarily iron and chromium.

The most common applications of cation exchange techniques for Pu are (1) concentration from a dilute solution, or (2) separation from nonabsorbable impurities, such as hydrazine.⁴¹⁹ Several processes for final purification and concentration of Pu from solvent extraction plants have been developed. These processes should be easily adapted to the laboratory scale. Bruce⁶⁰ describes the process as adsorption of Pu(III) from 0.25 M HNO₃ by Dowex-50 X 12 from a 0.15 g/l solution of Pu(III) which is 0.1 M in hydroxylamine sulfate, washing with 0.1 - 0.25 M HNO₃ containing 0.05 M hydroxylamine sulfate, and eluting with 5.7 M HNO₃ containing 0.3 M sulfamic acid to prevent oxidation to Pu(IV). Bruce reports a concentration

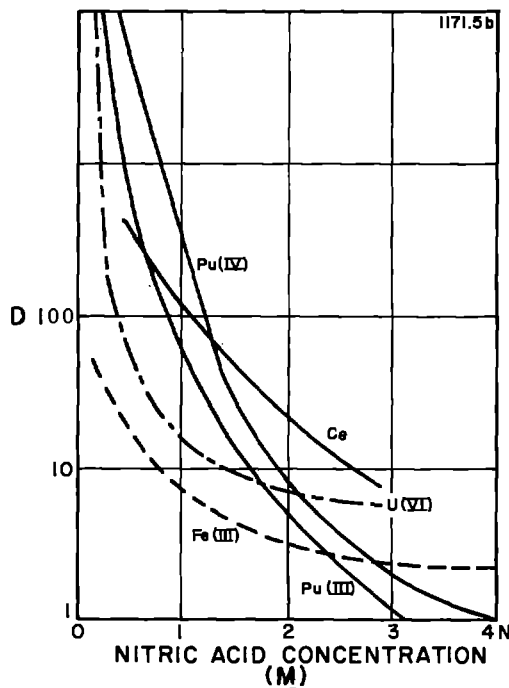

Fig. 43. Distribution of Pu(III) and Pu(IV) and other ions between nitric acid solutions and the cation resin C-50 (similar to Dowex-50).³²⁵

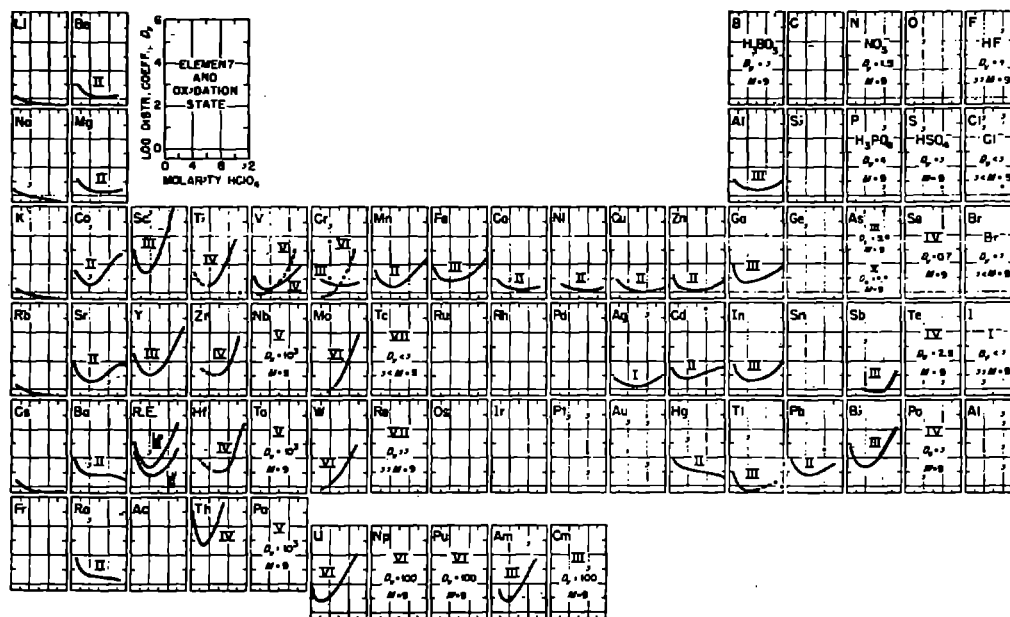

Fig. 44. Volume distribution coefficient of the elements vs HClO_4 concentration for Dowex-50 X 4 cation exchange resin.³⁰⁰

TABLE IV-28. Distribution Coefficients for Pu for Various Cation Resins in H_2SO_4 Solutions²⁹⁹

Resin	H_2SO_4 Concentration (M)	$D_{\text{Pu(III)}}$	$D_{\text{Pu(IV)}}$
Duolite C-65	0.5	5.3	35
Dowex 50 X 8	0.5	360	--
	3.6	3.6	--
Dowex 50 X 12	0.25	144	--
	0.5	1470	--

factor of 330 for Pu in this process. Decontamination factors of approximately 20 to 30 for Zr and Nb, and 2.4 to 8 for most other ions were obtained.

During the entire process the Pu is kept trivalent for several reasons; among these are (1) the Pu is initially trivalent as it is stripped from TBP in the Purex process, (2) oxidation during adsorption liberates gasses which may channel the resin and (3) Pu(III) is more easily desorbed, permitting a higher concentration factor.

Durham and Aiken¹¹⁹ describe essentially the same process. Prevot et al.³²⁵ Lingjaerde²⁵⁵ and Sikkeland³⁸² elute with 6-8 M HCl in preparation for

anion exchange in an HCl system. The latter workers use an additional 2 M HCl wash to elute the U(VI) and some fission products before elution of the Pu. Pm and Ce were the major contaminating fission product activities in this procedure (see procedure insert VIII). Den Boer and Dizdar¹¹⁴ used the same general scheme except 1.5 N HNO₃ was used to elute the UO₂⁺⁺ and hydrazine was the reductant, and the Pu(III) was eluted with 8 M HNO₃.

Chetham-Strode⁸⁶ investigated the behavior of NH₄(I), Fe(III), Pt(IV), and Al(III), which are common contaminants in the laboratory purification of trivalent actinides for spectrometer sources. His results are shown in Fig. 45 with Am(III) as a typical actinide. His procedure was to adsorb the ions from a very dilute HCl solution, wash with 1 M HCl, and elute with 6 M HCl.

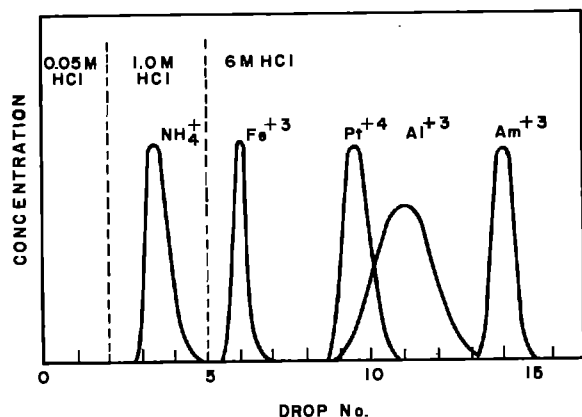

Fig. 45. Separation of Am from some common impurities by elution with HCl. The abscissa is drop number for a 0.3-cm diameter by 10-cm column. The resin used was Dowex 50 X 4.⁸⁶

Zolotov and Nishanov⁴³⁶ report the separation of Np from U, Pu and fission products by elution of Np(V) ahead of U(VI) by 1 M HNO₃ from the cation exchange resin KU-2. In the presence of 1 M HNO₃, Np(VI) is reduced to Np(V) on the resin. The Pu(IV) is then eluted with 3 M HNO₃.

Zagrai and Sel'chenkov⁴³⁵ separated Np and Pu by elution from cation resin (KU-1 and KU-2) with 0.02 M hydrofluoric acid after reduction to Pu(III) and Np(IV) with SO₂ for 20 minutes at 90-100° C.

The preparation of cation exchange resin beads with scintillating properties was reported by Heimbuch and Gee.¹⁷² Polyvinyl toluene-divinylbenzene mixtures were polymerized with p-terphenyl and 1, 4-bis- 2-(5-phenyloxyazoly) -benzene as scintillators. The resin beads were then surface-sulfonated, to give capacities ranging from 0.01 to 0.1 milliequivalents/gram. Sr⁹⁰, Pu²³⁹, and Po²¹⁰ have been adsorbed with this resin and counted with efficiencies from 30 to 50% of the adsorbed activity. Several applications are suggested:

1. Easy sample preparation for adsorbable radionuclides.
2. A combination of concentration of ions from dilute solution and sample preparation.
3. Rapid qualitative analysis for radionuclides in dilute solutions.

Kennedy et al.²²² prepared and tested phosphorylated resins, which are analogous to acidic phosphorous compounds in solvent extraction systems. They found that these resins are between carboxylic and sulfonic resins in acidity. The adsorption

affinity of several ions was $\text{Th(IV)}, \text{U(IV)} > \text{U(VI)}, \text{Fe(III)} > \text{La(III)} > \text{H}^+ > \text{Cu(II)}, \text{Co(II)}, \text{Ca(II)} > \text{Na}^+$. Pu was not measured, but Pu(IV) would presumably be with Th and U.

Inorganic Ion Exchangers

Although inorganic ion exchangers have been long known, they have been largely superseded by the synthetic resins, principally because of the higher capacities and more tractable physical characteristics obtainable in the synthetic exchangers. However, experimentation has continued on natural and synthetic compounds. In the actinide field this work has proceeded primarily toward the finding of better separations from fission products. The inorganic exchangers are also quite resistant to radiation damage, which is an advantage in process applications.

A general discussion of the ion exchange properties of hydrous oxides has been given by Kraus et al.²⁴² Inorganic phosphates as ion exchange materials have been reported.^{31, 139} The use of zirconium phosphate to separate Pu, U, and fission products has been reported by Gal and Ruvarac.¹⁴⁰ Equilibrium distribution coefficients for a number of ions are shown in Fig. 46, plotted against nitric acid concentration. The solution containing U, Pu and fission products was loaded onto a column at $0.5 \text{ M HNO}_3 + 0.02 \text{ M NaNO}_2$. The U, Ce, Sr, and Ru pass through the column. After washing the column, the Pu and Cs are removed with 8 M HNO_3 . The Zr and most of the Nb stay on the column. Of the ions studied, only Cs follows the Pu and must be separated by an additional step.

Ahrland et al.^{21, 22} studied the behavior of several ions on silica gel and proposed a separation of Pu, U and fission products similar to the one described for zirconium phosphate above. The distribution coefficients are plotted as a function of pH in Fig. 47, revealing an easy separation of Zr, U, Pu, and other ions by pH and valency adjustment.

Rydberg³⁴¹ separated Zr-Nb from Pu by adsorption of the former on silica gel from a 6 M HNO_3 solution (see Procedure 11 in Sect. VIII).

Cvjetcanin¹¹² extracted Pu(VI) and U(VI) with hexone in the presence of silica gel to effect a Zr-Nb separation.

Cvjetcanin and Cvjetcanin¹¹³ used a column of MnO_2 to separate U and Pu from long-lived fission products. The method is adsorb the fission products from 0.1 N HNO_3 , while passing U(VI) and Pu(VI) through the column. Over 99% of the Zr, Ru, and Cs activity was adsorbed on the column. The capacity for zirconium for MnO_2 dried at 110°C was determined to be 1 milliequivalent/gram.

An exchanger composed of Zr and Si oxyhydrates has been prepared and applied to Pu separations.²⁹⁷

Pu has been concentrated from environmental water samples by chemisorption of Pu(IV) on calcium fluoride from a nitric acid solution³⁵² (see Procedure 13 in Sect. VIII).

Kennedy et al.²²³ describe the absorption of Pu(IV), U(VI), Ru, Zr, and Nb from aqueous carbonate solutions by hydrated titanium oxide (HTO). About

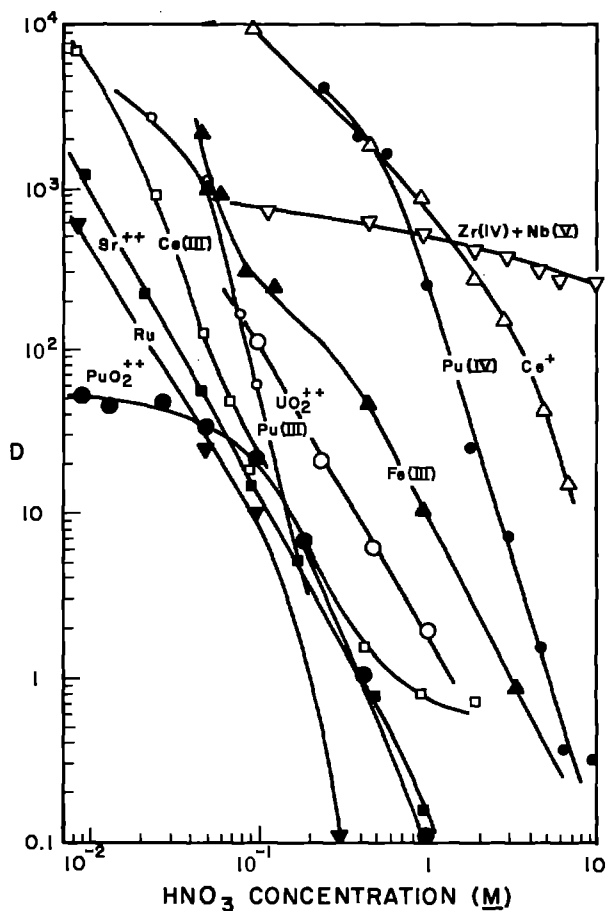

Fig. 46. The dependence of the distribution coefficients of several ions on zirconium phosphate on the aqueous HNO_3 concentration. All adsorbates present in tracer amounts. Solutions of Pu(III) were 0.005 M in sulphamic acid and 0.015 M in hydrazine; solutions of Pu(IV) 0.02 M in NaNO_2 and solutions of PuO_2^{++} 0.02 M in KBrO_3 .¹⁴⁰

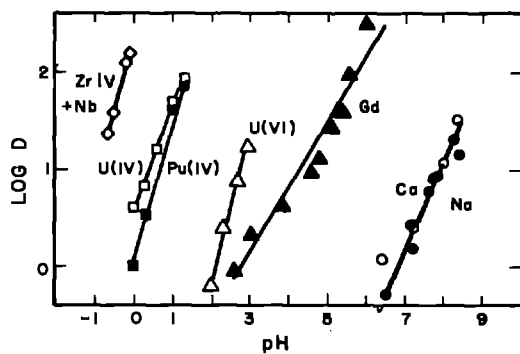

Fig. 47. Log D for some metal ions as a function of pH on silica gel (KEBO, 50-100 mesh).²²

95% of Pu(IV) was removed from a 0.5 M Na₂CO₃ solution by passage of 2000-bed volumes at a flow rate of 1 ml/cm²/min of the solution through an HTO column. The absorption of Pu(IV) was not affected by the presence of 5 mg/l of U(VI). The absorption of Pu(VI) was only 20% in 1000-bed volumes under the same conditions. A possible application of this system to recover Pu and other ions from carbonate wastes in processing plants is discussed.

Paper Chromatography

Clanet ⁹⁰ determined paper chromatographic R_f values for Pu(III), Pu(IV) and Pu(VI), U(IV), and U(VI), and Am(III) in HCl-butanol mixtures (1:1) ranging from 1 to 10 M HCl. The R_f values reached a maximum around 6 M HCl and ranged from 0.27 for U(IV) to 0.50 for U(VI), the other ions falling in between. The ions of lower valency tended to have lower R_f values.

Bildestein et al. ⁴⁷ separated U and Pu by several paper chromatographic methods, using different combinations of solvent and acid. The use of ion-exchange paper to separate U and Pu was also reported by these workers. For example, with Whatman ET-20 using 6 M HCl as a developer, the R_f values are 0.56 and 0.98 for U and Pu, respectively. The oxidation states of the U and Pu were not specified.

Fink and Fink ¹³¹ investigated many combinations of solvent and acid to develop paper chromatograms of both Pu(IV) and Pu(VI). In most systems Pu(IV) failed to move or streaked, but in a few cases moved quantitatively. The results indicated Pu(VI) and U(VI) might be separated in a methyl ethyl ketone - dilute nitric acid system.

Anion Exchange

The behavior of the actinide elements in various oxidation states on a strong base anion exchange resin (typically Dowex 1 or 2) in HCl is shown in Table IV-29. Strong adsorption of the actinides in the higher oxidation states (IV-VI) occurs at HCl concentrations above 6 M while desorption occurs below 2 M HCl.

TABLE IV-29. Absorption and Desorption of Actinides on Strong Base Anion Exchangers in HCl Solutions

Oxidation State of Actinide	HCl Concentration (M) for	
	Absorption ^(a)	Desorption ^(b)
III	Not absorbed	-
IV	6-8	2-4
V	6-8	2-4
VI	2-3	0.1-1

^(a)K_d = 10-100 for absorption.

^(b)K_d = 0.1-1.0 for desorption.

A convenient way of separating Pu from other actinides and most other elements is to adsorb Pu(IV) or Pu(VI) onto such a resin from > 6 M HCl solution, wash with HCl, and desorb by reducing the Pu to the trivalent with a suitable reducing

agent. This method is so simple and effective that it has become one of the standard laboratory methods for the separation of Pu, as well as in larger scale process plants.

Pu(IV) may be also adsorbed from 7 M HNO₃ solutions and desorbed either by dilute acid or by reduction. The distribution coefficients and separation factors from fission products are higher than in the HCl system, but the room temperature reactions are slower, resulting in some loss of convenience. ³²⁵

Many of the procedures collected in this volume are based on anion exchange.

Wish and Rowell ^{432, 433, 434} have determined equilibrium distribution coefficients for several actinide and other elements for Dowex-2 in HCl, HNO₃, H₂SO₄, and HCl-HF solution with results shown in Figs. 48-51. Although no Pu data in HNO₃ was obtained by these workers, the curves are included for comparison. Dowex-2 is made by addition of dimethylethanol amine to chloromethylated polystyrene, while Dowex-1 is made with trimethylamine. ¹⁷⁵ The equilibrium distribution data for the 2 resins is quite similar, e. g. for U(VI) ^{434, 240} so that the behavior of the actinides in Dowex-2 is also valid for Dowex-1. The behavior of the ions in the HCl-HF mixture shows the effect of strong HF complexing in Zr and Pu. These workers separate Pu from Zr and other elements by eluting the Zr with 11 N HCl - 0.06 M HF, and the Pu and Np together with 6.5 N HCl - 0.0004 N HF.

Marcus ²⁶⁶ measured distribution coefficients for macro amounts of U, Np, and Pu in the tetra- and hexavalent states on Dowex-1. The oxidation states of the ions in these experiments were measured spectrophotometrically both in the solution and in the resin phase. The results, which differ somewhat from those above are shown in Fig. 52 as volume distribution coefficients, D_v, obtained by multiplying the usual D by the resin bed density, 0.45, in this case.

Hardy ¹⁶² has summarized equilibrium data for the actinides in HNO₃ and HCl solutions for various strong base quaternary anion resins. These are shown in Fig. 53. The Pu(IV) data in HNO₃ show significant differences for different resins and different workers. The species adsorbed from 7 M HNO₃ has been shown to be Pu(NO₃)₆. ^{337, 120}

Data for the adsorption of other elements on Dowex 1 from HCl solutions ²⁴⁰ and HNO₃ solutions ¹²⁷ are shown in Figs. 54 and 55. The great specificity for actinides in the higher valence states is shown by Fig. 55.

Many examples exist of the use of anion exchange resins for Pu separations, both in HCl and HNO₃ solutions. Adsorption in 8 to 12 M HCl and elution by reduction to Pu(III) with NH₄I in 8 M HCl, ^{108, 382, 447, 185, 383} with HI in concentrated HCl, ^{185, 293} or with NH₂OH and NH₄I in concentrated HCl ⁴³⁴ are common procedures. An alternative procedure which has been used ^{293, 155} is to adsorb Pu(IV) from 7 M HNO₃, wash the column first with 7 M HNO₃, then with concentrated HCl, and finally strip in 10 M HCl - 0.5 M HI or NH₄I solution. This method combines the advantages of the somewhat greater selectivity and removal of iron of the nitrate system with the ease of reduction to Pu(III) of the chloride system with resulting small strip volume. The elution of Pu(IV) by HCl-HF mixtures has been mentioned before. ^{432, 433} These

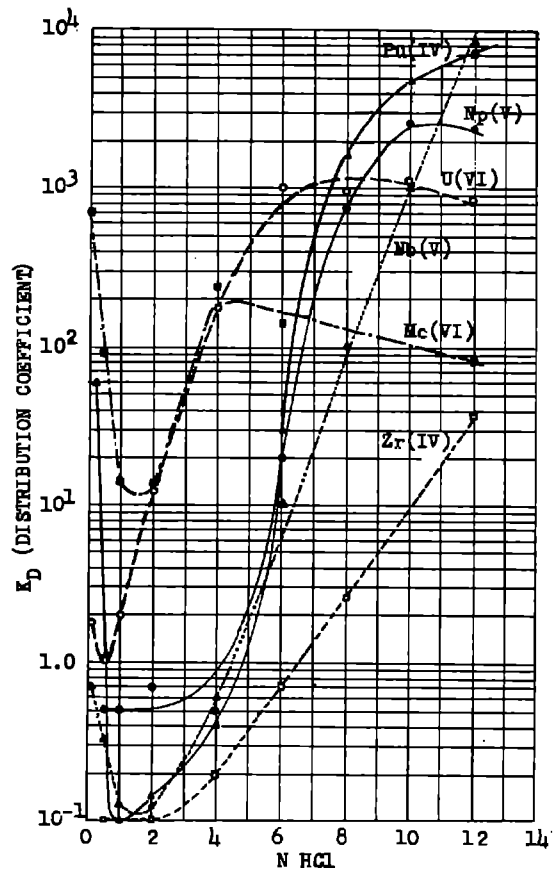

Fig. 48. Equilibrium distribution coefficients for Dowex 2 in HCl solutions.^{432, 433}
 (Mo, Zr, and Nb curves furnished by L. R. Bunney et al.⁶⁸)

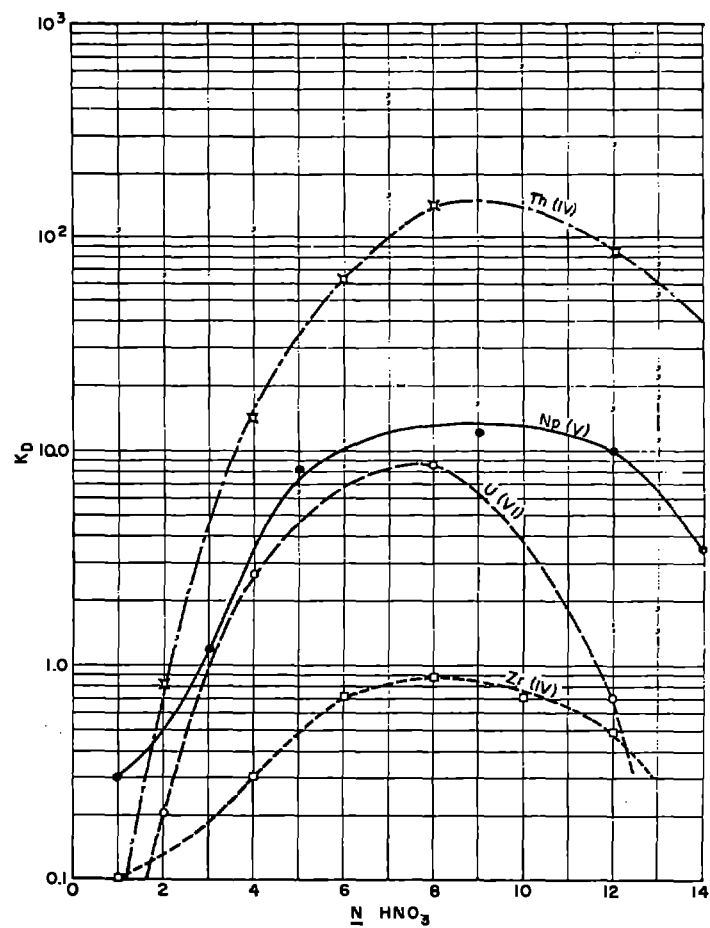

Fig. 49. Absorption of various ions by Dowex 2 from nitric acid solutions.⁴³³

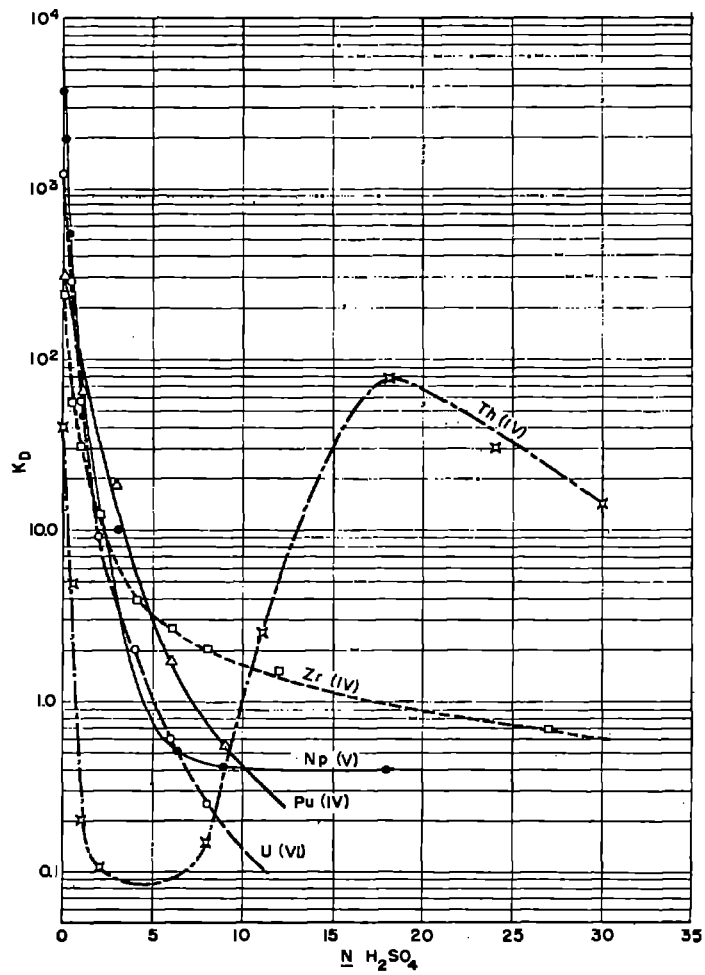

Fig. 50. Absorption of various actinide ions from H_2SO_4 solutions by Dowex 2.⁴³³

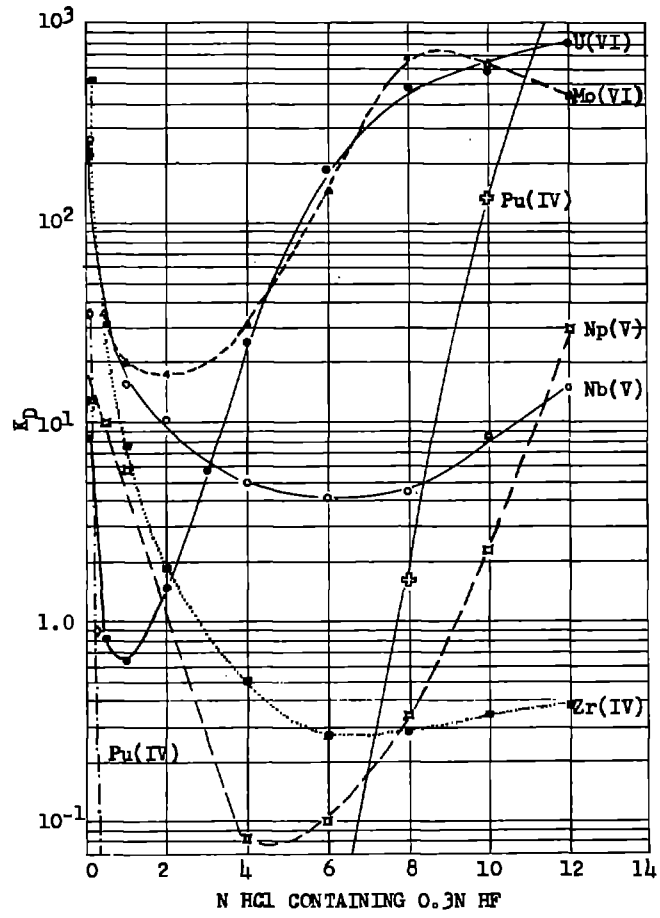

Fig. 51. Equilibrium distribution coefficients of various ions on Dowex 2 in HCl - HF solutions. 432, 433

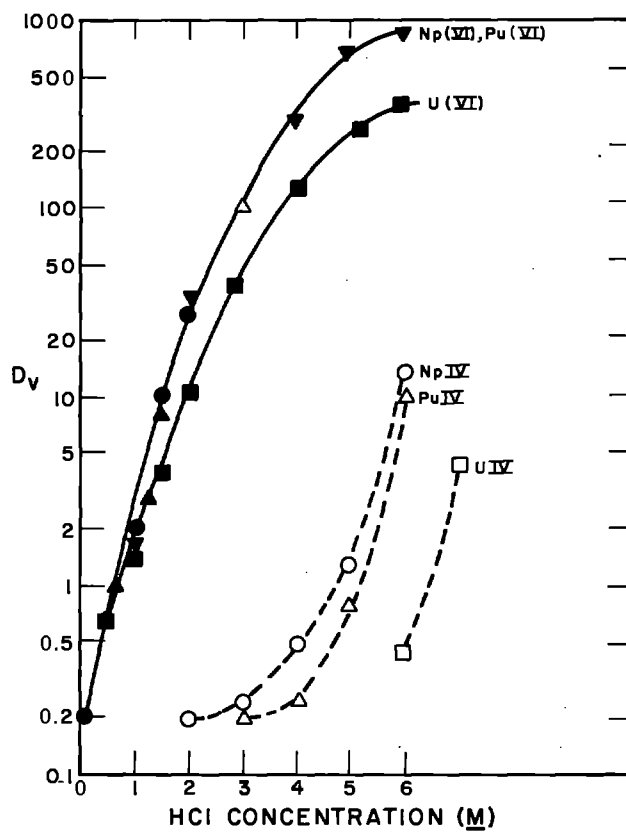

Fig. 52. Volume distribution coefficients, D_v , for tetra and hexavalent U, Np, and Pu between Dowex 1 and hydrochloric acid solutions.²⁶⁶

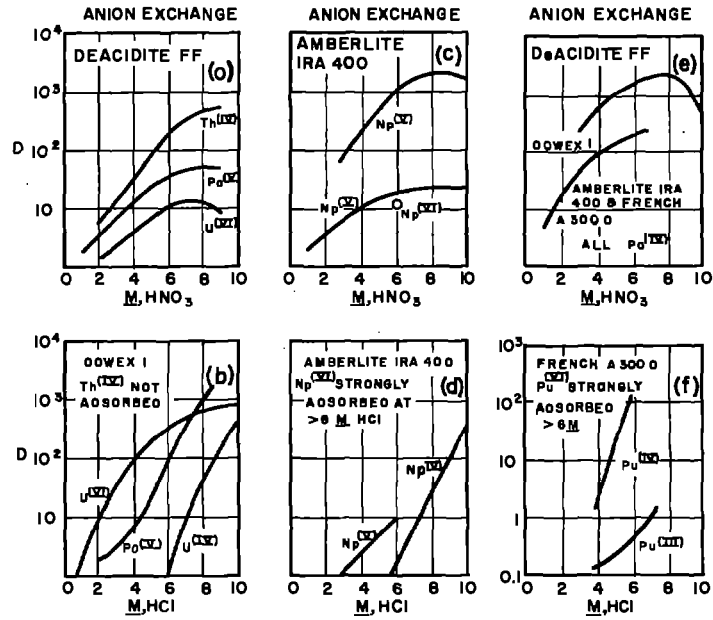

Fig. 53. Equilibrium distribution coefficients for actinides on various strong base anion exchangers. 162

Individual references:

- a) Pa; Hardy *et al.* 163
Th and U; Carswell 80
- b) Kraus and Nelson 240
- c, d) Ward and Welch (unpublished data)
- e) De-acidite FF; Phillips and Jenkins 319
Dowex 1; Aiken 23
Amberlite 1 RA 400 and French A 300 D; Prevot *et al.* 325
- f) Prevot *et al.* 325

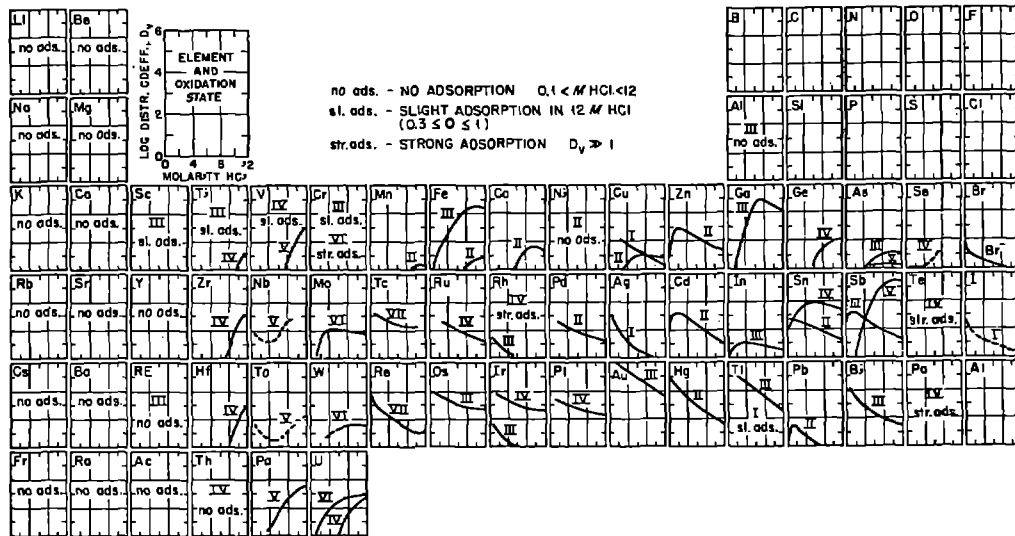

Fig. 54. Adsorption of the elements from hydrochloric acid solution by Dowex 1.²⁴⁰

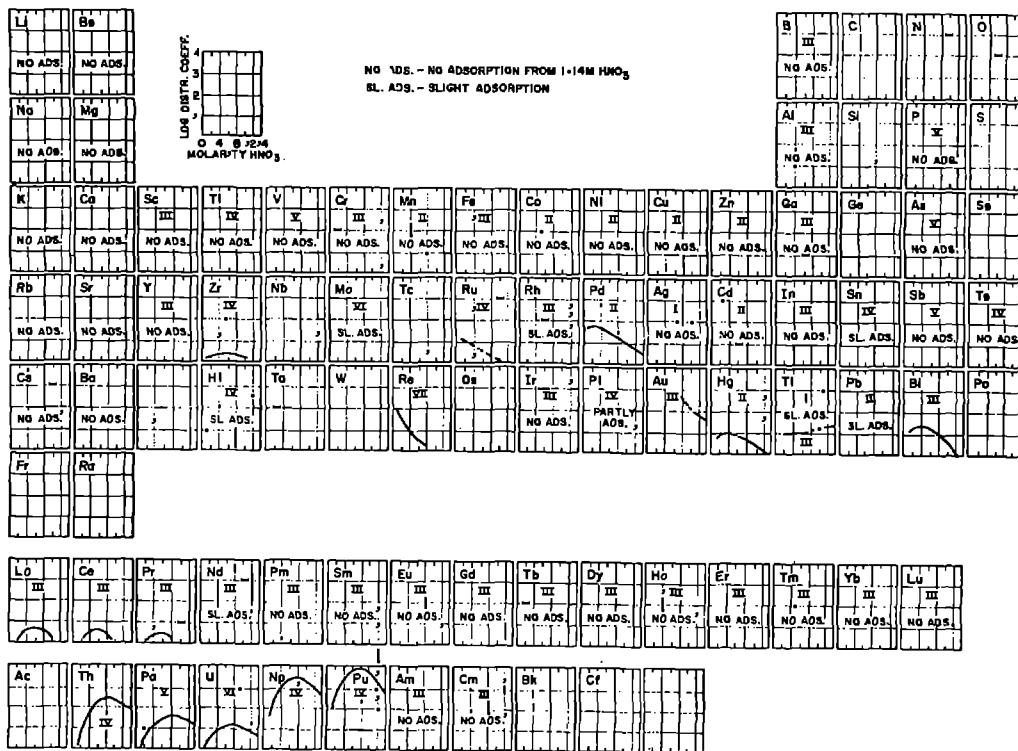

Fig. 55. Removal of elements from solution in 1 M nitric acid with strongly basic anion-exchange resin.¹²⁷

methods have been incorporated in sequential separation schemes for Pu and many other elements. 108, 432, 433, 434 Np and Pu have been separated by reduction of the Pu with NH_4I before adsorption on the resin. 204

The removal of macro amounts of Pu before analysis of other elements is commonly done by anion exchange either from HNO_3 or HCl solutions 280, 405, 319, 55 for example .

The separation of Pu from U by adsorption of U(VI) on anion exchange resin in 60% ethanol which is 2 M in HCl has been reported. 298 Pu is reduced to Pu(III) with hydroxylamine and is not adsorbed in this form. The advantage of this system over a pure aqueous one is low shrinkage of the resin and rapid adsorption and desorption of the U(VI).

In the nitrate system Pu is usually adsorbed from 6 to 8 M HNO_3 because the distribution coefficient decreases above this concentration and because resin degradation becomes a problem at high acid concentrations. The applications are either to separate Pu, or to separate other materials from Pu.

Roberts and Brauer 333 separate Am, Pu, and Np by adsorbing the Pu and Np from 8 M HNO_3 , eluting the Pu with 0.02 M ferrous sulfamate, and finally eluting Np by oxidation with Ce(IV) sulfate in 0.25 M HNO_3 . In another method, Th is included in the separation scheme by adsorption of Th(IV), Pu(IV) and Np from 8 M HNO_3 , elution of the Th by 12 M HCl, of Pu by 12 M HCl - 0.1 M NH_4I , and of Np by 4 M HCl. These authors report a clean separation with greater than 95% yields by both methods.

Buchanan et al. 66 report separations of U, Mo, Ce, and Zr from Pu by anion exchange methods in analysis of Pu-"fissium" binary alloys for these elements.

Other eluting agents for Pu adsorbed on anion exchange resin in the nitrate system are hydroxylamine 159, 419, 319, 189 and 0.36 M HCl - 0.01 M HF. 243

Kressin and Waterbury 243 used a "slurry-column" technique for the rapid separation of Pu from other ions. The 7 M HNO_3 solution of the ions is slurried with about half of the resin to adsorb the bulk of the Pu before placing in a column containing the other half of the resin. The solution can then be run through the column at a more rapid rate without Pu breakthrough, because most of the Pu is already adsorbed. These authors used a low cross-linked resin (Dowex 1 x 2) to speed the kinetics of the adsorption reaction. They report greater than 99.9% recovery of the Pu by this technique when mixed with substantial quantities of over 40 elements. The Pu is desorbed with an HCl-HF mixture, again to speed the elution.

Anion exchange from HNO_3 solutions is used as a unit process in a number of large scale processes of different types. Among these are: (1) the concentration and purification of Pu following a solvent extraction separation; 338, 339, 340, 325, 255 (2) the recovery of Pu metal scrap; 336, 331 and (3) the main separation step from fission products. 23, 57 The separation of Pu and Th in HCl solutions has also been described. 207

Anion exchange methods have been used in several procedures for the determination of Pu in biological material, 33, 404 especially urine. 205, 74, 254, 421

Toribara *et al.*⁴⁰³ used a liquid scintillation technique for counting Pu from biological materials. The counting was done by a single-phase mixture of sample in aqueous solutions, absolute alcohol, and liquid scintillator.

Electrolytic Separation Methods

Separation methods based on electrolysis have been used for radiochemical applications, but are not common because of the relative complexity of the method. In very early work, Cook¹⁰¹ found that Pu could not be separated from Np and U by electrodeposition from acetate solutions at pH 6-7. However, Samartseva³⁴⁴ found that U, Pu, and Np could be separated by electrolysis from nitric acid solutions by varying the pH. His results are shown in Fig. 56 as a plot of % yield vs pH for the stated conditions. Optimum conditions for the separation are stated as (1) current density 750-1000 ma/cm², (2) plating time 2 to 3 hours, and (3) solution volume 20 to 40 ml.

Samartseva also found that electrolytic separation of Pu was successful against many competing ions in concentrations up to 0.5 mg/ml. Among the ions tested were Fe, Al, La, Ba, Cr, Mn, Ca, Mg, Bk, and Na. Of these only Fe interfered with the separation to an appreciable extent. Oxalic acid at 0.002 M concentration was added to complex the Fe.

On the other hand, Sinitsyna *et al.*³⁸⁴ found that the deposition of U and Pu was strongly dependent on pH and current density, but that quantitative separations could not be achieved at any pH from nitric acid solutions and acetate buffers.

Rein *et al.*³²⁹ separated Pu from Cr, Co, Ni, Fe, Pb, Mn, Sn, and Zn by deposition of these elements on a Hg cathode from 1 N HCl. Porter³²¹ found that Pu metal could be deposited on a mercury cathode from an organic solution, and determined that dimethyl sulfoxide solution saturated with the metal chloride was the best solvent among those investigated.³²²

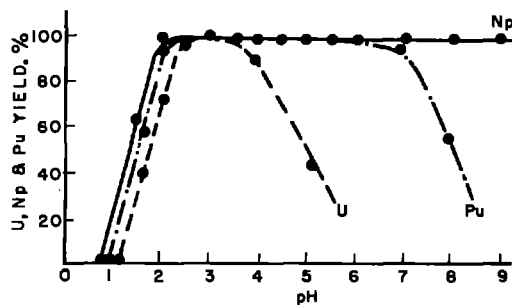

Fig. 56. Relation of element yield to solution pH. The current density on the cathode was 100 mA/cm² and the electrolysis time, 2 hr. The solution was nitric acid.³⁴⁴

Clanet *et al.*⁹¹ separated U(VI), Pu(IV), Am(III), and Cm(III) by paper electrophoresis using 10 M HNO₃ as the electrolyte. A plot of a radioactivity scan of their "electrophoretogram" is shown in Fig. 57, which gives the experimental conditions. U(VI) would lie between Pu(IV) and Am(III) in this plot, according to the measured mobilities in this system.

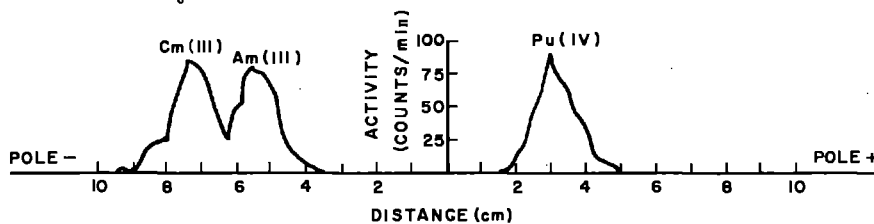

Fig. 57. Separation of Pu(IV)-Am(III)-Cm(III).⁹¹ Electrolyte: 10 NHNO₃. Support: "Millipore" HAWP paper. Development voltage: 250 volts. Time: 6 hours.

V. DISSOLUTION OF PLUTONIUM SAMPLES FOR ANALYSIS

A. Metallic Plutonium

Plutonium metal dissolves in HCl and other halogen acids, but not in HNO_3 or concentrated H_2SO_4 . Dilute H_2SO_4 attacks Pu slowly.¹ The addition of HF to HNO_3 renders Pu soluble.⁴²⁸ Sulfamic acid has been used to dissolve Pu metal.²¹⁰

Pu-Al alloys can be dissolved in 6 M HNO_3 - 0.05 M $\text{Hg}(\text{NO}_3)_2$ - 0.02 M HF,³¹⁷ as well as HCl and HClO_4 . An alternative method is to dissolve the Al in a solution of NaOH - NaNO_3 . The Pu and other actinide elements can then be dissolved in boiling HNO_3 or HCl after filtration.^{317,166}

B. Other Compounds

PuO_2 , if ignited, dissolves only with great difficulty in the usual acids. Boiling with concentrated nitric acid plus 0.005 M HI,^{445,328} with 85-100% H_3PO_4 at 200° or with 5-6 M HI⁴⁵¹ have been recommended methods. Another method is fusion with ammonium bifluoride, followed by treatment with aqueous aluminum nitrate or acid.^{107,62} Ignited Pu oxalates and fluorides have been dissolved by fusion with potassium bisulfate, dissolving the residue in water to precipitate $\text{Pu}(\text{OH})_3$, and finally dissolving the hydroxide.²⁶³ The sealed tube method of Wichers *et al.*^{453,4} has been used to dissolve Pu-containing samples.⁴⁵⁴

C. Biological and Environmental Samples

The Pu in these samples ranges from readily soluble in the case of metabolized plutonium in excreted samples, to extremely refractory in the case of fallout samples. Nielsen and Beasley³⁰³ describe methods for dissolving various biological samples. Most procedures for dissolving fallout or other environmental samples involve treatment with HF or a basic fusion step which renders the Pu soluble in acids.

VI. SOURCE PREPARATION AND COUNTING METHODS

A. Source Preparation

A universal problem in Pu radiochemistry is the preparation of sources suitable for counting. Owing to the short range of alpha particles in matter, the thickness of foreign material on the counting sample is limited to approximately one mg/cm^2 for counting without serious loss. The requirements are much more severe if the ratios of alpha-emitting isotopes are to be determined by energy analysis. This is so because an alpha particle will be degraded in energy by interaction with the surrounding medium, and the resulting pulse height distribution will be smeared out.

Most of the methods used for preparing alpha counting sources in use today were developed in the Manhattan Project. Jaffey²⁰⁶ and Hufford and Scott¹⁸⁹ summarize the project experience. Source mounting techniques are, in general, a trade-off of quantitativity on the one hand with thinness on the other. In assay work it is very important to be quantitative but not so important to have a "thin" sample. On the other

hand, for the separation of alpha particle energies by energy analysis the thinness of the source is paramount, while quantitativity is not required, at least in the case of isotopic dilution analytical methods.

Table VI-30 is a summary of the project method for alpha source preparation. The reviews mentioned above are the primary source of this information and should be consulted for more detail and literature references. Other general reviews may be consulted for a discussion of the problem of mounting thin sources.^{212,386,307}

Two of the most widely used methods for preparation of alpha sources on a metal backing for counting or spectroscopy are (1) direct evaporation of an aqueous or organic solution and (2) electrodeposition. Other methods, such as volatilization of the sample in a vacuum, adsorption from an aqueous solution, are not so widely used. However, the method of vacuum "flashing" from a tungsten filament produces very satisfactory sources and is in routine use in some laboratories. (See for example Procedure 4 in Sect. VIII.)

A.1 Direct Evaporation

This method has the advantage of speed and simplicity and the disadvantage of tending to concentrate any mass present in the solution to produce local thick areas. The classic "LaF₃" method for the determination of Pu utilizes direct evaporation of a slurry of LaF₃-Pu, followed by alpha counting to determine the Pu⁴⁴⁶ (Procedure 1 in Sect. VIII). In general, the method is satisfactory if only total alpha counting is to be done. However, in methods which depend on alpha energy analysis, direct evaporation of even a "carrier free" solution will not be completely satisfactory. The reason for this failure lies in the above mentioned concentration effect to produce an effectively "thick" plate. The great advantage of other methods in this regard is that the Pu and impurities in the solution to be plated are spread evenly over the entire area of the plate.

Tuck⁴⁰⁶ describes a method for evaporating organic solutions of alpha-emitting materials by heating only the edge of a circular plate, thus confining the liquid to the center. The same principle was used by Westrum⁴²⁶ to evaporate sulfuric acid solutions.

A.2 Electrodeposition

This method has the advantage of producing thin uniform plates suitable for energy analysis of the alpha particles, and the disadvantage of requiring a relatively complex apparatus and relatively greater effort. The time to produce one sample can be as much as two hours.

Ko²³³ gives specific conditions for electrodeposition of the actinides from Th to Cm. He chose a buffered solution of formic, perchloric or sulfuric acid and ammonium formate and achieved high yields for up to 100 μg of Pu at current densities of 100-300 mA/cm². The deposition of all these elements occurs as a precipitation reaction at the cathode. In the case of Pu, the compound precipitated is Pu(OH)₄ (hydrated). Moore and Smith²⁸⁸ also used an acid solution of ammonium oxalate to electrodeposit Pu. Mitchell⁴⁵² gives a rapid method for electroplating trace quantities of actinides from HCl-ammonium chloride solutions. He gets essentially quantitative deposition in 15 minutes from a 0.1-0.2 g/ml chloride solution at pH about 1 using a current density of 1 A/cm².

TABLE VI-30. Source Preparation Methods for Alpha Radioactivity Measurements^(a)

Method and Principle	Applications	Advantages	Disadvantages
1. <u>Normal Evaporation</u> - Placing solution on a suitable backing, usually Pt, and evaporation under a heat lamp, and igniting. Solution may be pipetted quantitatively if desired.	1. Preparation of sources for alpha counting from aqueous solution. 2. Preparation of sources for alpha counting from organic solution.	1. Rapid, convenient, quantitative. 2. Easier to get uniform spreading. Organic may not have refractory impurities.	1. Sample not uniformly spread if >25 μg of material. May cause error due to self adsorption. 2. Same as 1 + more difficult to prevent loss over edge of plate. May require edge heating or stippling small volume at a time.
2. <u>Slurry Transfer of Carrier Salts</u> - Co-precipitation with suitable salt, transfer to plate, spread, evaporate and ignite.	Volume reduction for cases where solvent extraction or ion exchange methods are not applicable.	Relatively fast, easy method.	Co-precipitation and transfer may not be quantitative. Requires at least 0.3 mg of carrier. Self absorption losses may be serious.
3. <u>Electrodeposition</u> - Electrolytic reduction of plutonium at a platinum cathode.	Preparation of sources for energy analysis.	Very thin, uniform films are attainable. Method can be made quantitative.	Requires special preparation of solution, requires relatively long time to prepare 1 sample.
4. <u>Low Temperature Sublimation in Vacuum</u> - Prepare volatile compound, place in low temperature oven in vacuum, collect vapor on suitable cold plate. The volatile compound is rendered non-volatile and the organic material destroyed by ignition.	Preparation of extremely thin sources for highest resolution alpha energy analysis.	Excellent sources - any kind of backing may be used.	Only a small fraction of sample collected. Volatile compounds are difficult to handle and constitute a health hazard. Not a routine method.
5. <u>High Temperature Sublimation in Vacuum</u> - Place material in oven with suitable orifice, evacuate and volatilize at high temperature. Collect on a cold plate. The oven may be a dimpled W or Ta strip heated by resistance heating. In this case the plate need not be cooled.	Preparation of high quality thin samples for alpha energy measurements.	Very good sources obtainable. Resistance heated strip method applicable to routine isotopic dilution analysis.	Not quantitative, however under favorable conditions ~90% yield can be obtained. Yield is usually about 50%. The apparatus is relatively large and expensive.

^(a)Compiled from References 206 and 189.

Miller and Brouns²⁷⁶ give a detailed procedure for electrodeposition of Pu(VI) from 1-2 N KOH solution. The Pu was oxidized with ozone. This method has the disadvantage that all elements which precipitate in basic solution interfere with the deposition.

A. 3 Other Methods

El Guebely and Sikkeland¹²² report an interesting method for preparation of extremely thin Pu sources. The basis of the method is adsorption of Pu(IV) onto glass or metal plates from dilute (~0.01 M) HCl solutions, presumably as the polymeric form. The method is not quantitative. Samartseva³⁴⁷ reports that adsorption of Pu(IV) is 97-98% complete on Pt from 10^{-1} to 10^{-3} M HNO₃ solutions.

Carswell and Milstead⁸¹ made thin sources of U and Pu by electrostatically focussing a jet of the material to be plated which was dissolved in a volatile solvent.

B. Counting

The subject of the determination of the amount of alpha radioactivity has been reviewed by Jaffey²⁰⁶ and recently by Johnson *et al.*,²¹³ and Hanna.¹⁶⁰ These accounts should be consulted for details of the various detection systems and literature references. Table VI-31 lists the major types of counting systems with applications, advantages, and disadvantages of each.

The ratios of the isotopes of Pu can be determined by making use of the difference in the energies of the alpha particles in alpha pulse analysis.

The isotope Pu²³⁶ is very useful as a tracer in this method. This isotope is prepared by the reaction

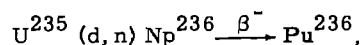

using highly enriched U²³⁵ to make the Pu²³⁶ as pure as possible. Since Pu²³⁶ is not made by any neutron reaction on U, an unspiked sample need not be run if the Pu²³⁶ is isotopically pure. Since the alpha energy Pu²³⁶ is higher than that of the other commonly occurring isotopes (Pu²³⁹, Pu²⁴⁰, and Pu²³⁸), care must be taken that the added Pu²³⁶ activity is not very much greater than the activity of the other Pu isotopes. The reason for this precaution is that imperfections in the sample and detecting instrument always result in low-energy alpha particles which appear as a continuum or low energy "tail" in the spectrum. The subtraction of this tail becomes difficult if higher energy isotope predominates.

C. Other Methods

Another isotopic dilution method uses the rare isotope Pu²⁴² as the tracer and a mass spectrometer as the detecting instrument. Highly enriched Pu²⁴² is a product of long reactor irradiations of Pu²³⁹.

A determination of the Pu²³⁹-Pu²⁴⁰ isotopic ratio must be made if the specific activity of a particular sample is needed. This determination must be made by means of a mass spectrometer since the alpha particle energy of these 2 isotopes is the same.

Schwendiman and Healy³⁶⁰ have described a nuclear emulsion technique for low-level Pu analysis. Nielsen and Beasley³⁰³ have reviewed the radiochemical determination of Pu in biological materials and include a critical comparison of various counting systems.

TABLE VI-31. Techniques for Measuring Alpha Radioactivity.

Method	Application	Advantages	Disadvantages
A. Total Alpha Activity			
1. Air ionization chamber	Total assay - survey instruments.	Simple, easily repaired and cleaned, reliable, inexpensive.	Long decay time of pulse makes inherently wide pulses - limited to low counting rates. Low tolerance to β activity.
2. Free-electron-gas ionization chamber (A, A-CO ₂ , He, N ₂ , etc.)	Total assay.	Sharp pulses permit high count rates and tolerance to β activity. Not microphonic. Reliable and stable. A known relatively unchanging geometry.	Signal-to-noise inferior to proportional counters, therefore more prone to spurious counts. Must be corrected for low-angle back scattering.
3. Alpha proportional counter	Total assay.	High signal-to-noise ratio, good β discrimination. Not at all microphonic.	Count rate sensitive to applied voltage. Requires pure gas for stability. Difficult to maintain stability for long periods.
4. Scintillation alpha counter	Total assay.	Very low background.	Lower tolerance to β radiation than ionization chamber or proportional counter. Greater sensitivity to sample size, and position.
5. Low-geometry counters	Total assay.	Can count sources of greater activity. Counting rate not so sensitive to sample thickness. Reproducible and reliable. No low-angle back scattering correction.	Not suitable for low activity. Sensitivity to sample position and area.
6. Nuclear Emulsions	Total assay.	Great sensitivity and stability. Very simple apparatus.	Limited accuracy, considerable technique required in exposing and developing emulsions. Counting tracks is time consuming and tedious.

TABLE VI-31. Techniques for Measuring Alpha Radioactivity (Cont'd)

Method	Application	Advantages	Disadvantages
<u>B. Alpha Energy Measurement</u>			
1. Magnetic deflection alpha spectrometer	Energy measurement - mainly for determination of energy spectrum.	Very high precision and accuracy.	Large, expensive equipment. Requires photographic technique for recording data. Counting tracks is tedious and time-consuming. Very low geometry. Thin sample required.
2. Total ionization and pulse analysis. Frisch grid ionization chamber	Energy measurement - determination of isotope ratios.	Convenient, easy to use. High geometry - up to 50%. Tolerates large area sources. Resolution can be improved by collimation.	Requires gas purification.
3. Semiconductor charged particle detector	Energy measurement - isotope ratios.	Very convenient - capable of high resolution.	Requires low geometry for high resolution. Detector may become irreversibly contaminated by volatile radioactivity.

Solvent extraction of Pu into a liquid scintillator has been proposed as a method to eliminate source preparation in radiochemical procedures.^{135, 403} The determination of the β activity of Pu²⁴¹ in low-level biological samples by this method has been reported.²⁵⁶

The incorporation of a scintillator in the polymerization of an ion-exchange resin has been reported¹⁷² (see page 81 for details).

Scintillation counting of the weak 0.4 MeV gamma-ray in Pu²³⁹ by NaI detectors¹²³ has been used to monitor the concentration of Pu in process streams.

VII. SAFETY CONSIDERATIONS

Hazards to personnel who work with Pu in the laboratory arise primarily from two causes. First, Pu is extremely poisonous because of its high specific alpha activity, long biological half-life, and tendency to concentrate in the bone. Second, inadvertent criticality may occur. A full discussion of these hazards is beyond the scope of this review, but some general comments concerning precautions and techniques can be made. The subject of personnel monitoring and radiation surveying has been treated by Morgan.²⁰¹ Appleton and Dunster³² have written a manual on the safe handling of Pu.

A. Radioactive Safety

The primary hazard is due to the possibility of ingestion, since the alpha particles are easily shielded and the gamma radiation associated with the common long-lived isotopes is slight. The hazard is better stated in terms of the activity level rather than the mass, since the biological damage is done by the alpha radioactivity and the isotopic composition of Pu varies widely. Table VII-32 lists body burdens and maximum permissible concentrations (MPC) of Pu isotopes for continuous occupational exposure. These data are taken from the National Bureau of Standards Handbook 69, which should be consulted for details.

TABLE VII-32. Health Hazard Data for Plutonium Isotopes.

Isotope	Maximum Permissible Body Burden in Bone (microcuries)	Maximum Permissible Concentration for 40-hour week (microcuries/cc)	
		Water	Air
Pu ²³⁸ soluble	0.04	10 ⁻⁴	2 × 10 ⁻¹²
Pu ²³⁹ , Pu ²⁴⁰ , Pu ²⁴² insoluble	—	8 × 10 ⁻⁴ (a)	3 × 10 ⁻¹¹ (b)
Pu ²⁴¹ soluble	0.9	7 × 10 ⁻³	9 × 10 ⁻¹¹
insoluble	—	0.04 (a)	4 × 10 ⁻⁸ (b)

(a) Assuming the gastro-intestinal tract to be the critical organ.

(b) Assuming the lung to be the critical organ.

The most common control practice is total containment of high activities of alpha-emitting isotopes by means of an enclosure which is maintained at a negative air pressure with respect to the laboratory atmosphere. Operations are done either with remote manipulators or with arm length gloves sealed to the enclosure.

In an intermediate or high-level alpha activity laboratory, a variety of auxiliary equipment and practices in addition to the primary enclosure of the activity, are necessary to insure personnel safety. Among these are:

1. Adequate monitoring of the accidental release or "spilling" of radioactivity. This monitoring can be done by hand-held survey instruments, by continuous filtering and monitoring of the laboratory air, and by personnel monitoring instruments placed at exits to the working area.
2. Protective devices and clothing. In most high-level radiochemical laboratories, special clothing is part of the laboratory practice. The availability of respirators to prevent inhalation of airborne radioactivity in the event of a spill is essential.
3. Procedures for normal operation of the laboratory as well as emergency procedures must be worked out in advance and understood by all personnel. "Good housekeeping," or the maintenance of a clean and orderly work space, should be especially emphasized.

The kind, amount, and distribution of protective devices, as well as laboratory practices for normal and emergency operation, vary considerably in detail from laboratory to laboratory. This very brief introduction to the subject of the handling and manipulation of large amounts of alpha activity is intended to serve mainly as a warning to the uninitiated. The subject of enclosures for radioactive materials is treated fully in a review by Garden and Nielsen.¹⁴²

Low activity can, of course, be handled in an ordinary radiochemical laboratory. The limit beyond which total containment becomes a necessity is not very well defined. The concentration of the alpha-active material, as well as the nature of the operation and the skill and care of the operator, are factors which must be considered. At the level of one microcurie, ordinary laboratory procedures can be done if reasonable care is taken, while at higher levels the operations become more and more limited. At the millicurie level total containment becomes necessary for any chemical operation. In any case, proper monitoring of the activity is essential.

B. Criticality Safety

This hazard is most generally met in the radiochemistry laboratory by only permitting an "always safe" amount of Pu in any room or area. This is an amount which will not be a critical mass in any configuration or dispersed in any medium. While the determination of the always-safe amount in a particular situation is beyond the scope of this review, Table 32 gives basic data for Pu²³⁹. This table was extracted from the USAEC Publication "Nuclear Safety Guide"⁴⁴⁴ which may be consulted for further information on this subject.

TABLE VII-33. Basic Data for Criticality Hazard for Plutonium-239.

Form of Isotope	Mass of Isotope (kg) which is maximum	
	Recommended for Safety	Minimum Critical
Metal, α phase ^(a)	2.6	5.6
Metal, δ phase ^(a)	3.5	7.6
Solution	0.22	0.51

^(a)The metal is assumed to be surrounded by a thick hydrogenous layer.

VIII. COLLECTION OF PROCEDURES

A. Introduction

The literature of Pu is replete with radiochemical and analytical separation procedures. A survey disclosed 54 papers with procedures which were written in enough detail to do justice to the name, and many more methods which could easily be developed into procedures by making the directions quantitative or more complete. Of the 54, 26 survived screening and are included in this collection. The basic criteria for screening were fourfold: (1) distinctiveness in chemistry, (2) completeness in detailed instructions, (3) generality in application, and (4) utility. In some cases a rather arbitrary choice had to be made between procedures which met these criteria equally well.

The procedures are divided into (1) general radiochemical procedures, (2) special purpose separation procedures, and (3) urinalysis procedures.

The procedures in the first group are concerned with purifying Pu from other alpha emitters and from fission products sufficiently for the purpose at hand, usually for alpha counting or alpha pulse analysis. The starting materials range from reactor target dissolver solutions of varying ages to fresh samples of nuclear explosion debris to very dilute environmental samples. There are 13 of these procedures included.

The second group of procedures is concerned with a specific separation involving Pu. Two examples are the separation of Np and Pu and the removal of Pu before analysis for impurities in Pu metal.

Urinalysis is a separate category, primarily because there are so many procedures in the literature, all purporting to do the same thing. The chemistry after the initial separation step is, of course, similar to that in the other categories. The urinalysis procedures included were chosen primarily for distinctiveness of chemistry.

B. Listing of Contents

General Radiochemical Procedures

<u>Procedure No.</u>	<u>Author (principal)</u>	<u>Title or method</u>	<u>Page</u>
1.	Welch	Determination of Pu when large amounts of Fe and Cr are present (LaF ₃ method)	108
2.	Moore	Separation and determination of Pu by TTA extraction	112
3.	Maeck	Separation and determination of Pu in U-fission product mixtures (extraction of quaternary alkylammonium-plutonyl nitrate complex into hexone-TTA extraction)	114
4.	Morrow	Plutonium (anion exchange)	116
5.	Hoffman	Plutonium (anion exchange)	118

<u>Procedure No.</u>	<u>Author (principal)</u>	<u>Title or method</u>	<u>Page</u>
6.	Hart	Separation and determination of Pu from U and fission products in irradiated reactor targets (anion exchange - TBP extraction)	122
7.	(No author)	Pu (CeF ₄ -LaF ₃ cycle, TBP extraction, anion exchange)	124
8.	Rider	U and Pu determination in highly irradiated fuel. (Hexone extraction, TTA extraction)	126
9a.	Lingjaerde	Pu from irradiated U (cation exchange, anion exchange)	129
9b.	Rydberg	Separation of Pu from U and fission products (BiPO ₄ precipitation, TTA extraction)	131
10.	Rydberg	Separation of Pu from U and fission products (adsorption of Zr-Nb on silica gel, precipitation of CuS, TTA extraction)	132
11.	Geiger	U and Pu from environmental samples of soil, vegetation and water (TBP extraction)	134
12.	Sheidhauer	Pu from environmental water samples (chemisorption on CaF ₂ , TTA extraction)	137
13.	Kooi	Pu from environmental water samples (BiPO ₄ precipitation, co-extraction with ferric cupferride)	140
<u>Special Procedures</u>			
14.	Larsen	Separation and spectrophotometric determination of Pu from U-Pu-fission element alloys (TBP extraction from HCl solution)	142
15.	Trowell	Separation of Pu before spectrographic analysis of impurities in Pu metal (anion exchange)	144
16.	Trowell	Separation of Pu before spectrographic analysis of impurities in high purity Pu metal (extraction chromatography using TBP)	148
17.	Jackson	Separation of Np and Pu by anion exchange	149
18.	Zagrai	Separation of Np and Pu by cation exchange chromatography	150
<u>Urinalysis Procedures</u>			
19.	Brooks	Determination of Pu in urine (ferric cupferride extraction)	153
20.	Perkins	Determination of Pu in urine (PrF ₃ precipitation, TTA extraction)	155

<u>Procedure No.</u>	<u>Author (principal)</u>	<u>Title or method</u>	<u>Page</u>
21.	Everett	Determination of Pu in urine (LaF ₃ precipitation, TTA extraction)	158
22.	Bokowski	Determination of Am in urine in the presence of Pu (BiPO ₄ precipitation, LaF ₃ precipitation extraction of Pu into di-(2-ethylhexyl) phosphoric acid)	161
23.	Campbell	Determination of Pu in urine (alkaline earth phosphate precipitation, anion exchange)	164
24.	Weiss	Determination of Pu in urine (co-crystallization with potassium rhodizonate, LaF ₃ precipitation, anion exchange)	166
25.	Bruenger	Determination of Pu in urine and bone ash (extraction by primary amines from H ₂ SO ₄ solution)	

Procedure 1. Determination of Pu in solutions containing large amounts of Fe and Cr. G. A. Welch et al. (Ref. 446).

Outline of Method

Hydroxylamine is added to the sample to reduce plutonium and chromium to the trivalent state. The acidity of the solution is adjusted and lanthanum nitrate carrier added. Lanthanum fluoride is precipitated by adding a limited amount of ammonium fluoride and carries the plutonium with it. By strictly controlling the amount of fluoride added the precipitation of iron and chromium is prevented. The precipitate is separated by centrifuging, washed and mounted on a flat stainless-steel counting tray, and the α -activity measured with a scintillation counter calibrated against standard sources.

Reagents

All reagents are analytical reagent quality where available.

1. Ammonium hydroxide, 9M
2. Nitric acid, 2M
3. Hydroxylamine hydrochloride, 5% w/v
4. Lanthanum nitrate solution, 5 mg La/ml.
Dissolve 7.8 g of lanthanum hexahydrate in 500 ml of distilled water.
5. Ammonium fluoride solution, 12.5% w/v
Store in a polythene bottle.
6. Cellulose lacquer.
Dilute "ZAPON" lacquer with amyl acetate.
7. Standard Pu solution, 0.5 $\mu\text{g/ml}$.
Dilute a solution of known Pu concentration. The exact Pu concentration of the diluted solution need not be known, but the isotopic constitution should be essentially the same as that of the samples requiring analysis.

Equipment

1. α -scintillation equipment.
Type 1093A or B scintillation unit with associated equipment.
2. Counting trays.
Stainless steel, flat, mirror finish, 1-1/16 in. diameter.

Prepare for use by heating in a flame until the surface is straw coloured. Allow to cool and paint a ring of cellulose lacquer round the edge. Allow the lacquer to dry and store the prepared trays in a closed container.

Procedure

1. Transfer a suitable portion of the sample to a 3 ml glass centrifuge tube. Wash out the pipette with 2M nitric acid and add the washings to the tube. [Note (a)].

2. Add 0.15 ml (3 drops) of hydroxylamine hydrochloride solution and stir well. [Note (b)].
3. Add 9M ammonia solution until a faint permanent precipitate is formed.
4. Add 2M nitric acid until the precipitate just redissolves, then add 0.1 ml (2 drops) in excess.
5. Add 0.1 ml (2 drops) of lanthanum nitrate solution (5 mg La/ml), dilute the solution to about 2 ml and stir well.
6. Add 0.15 (3 drops) of 12.5% ammonium fluoride solution, stir well and centrifuge for 10 min.
7. Remove the supernatant liquor [Note (c)] with a transfer pipette [Note (d)] and wash the precipitate twice by stirring with a mixture of 1 ml of water, 0.1 ml of 2M nitric acid and 0.25 ml of ammonium fluoride solution. After each wash, centrifuge for 5 min before removing the supernatant liquor.
8. Slurry the precipitate with 2 drops of water and transfer it to a prepared counting tray with a transfer pipette. Do not allow the slurry to enter the wider part of the tube. [Note (e)].
9. Wash the centrifuge tube with 5-10 drops of distilled water and transfer the washings and the residual precipitate to the counting tray. Spread the slurry evenly over the tray within the cellulose lacquer ring and break up agglomerations of solid matter with additional drops of water where necessary.
10. Dry the slurry beneath a radiant heater and ignite the counting tray in a flame to a dull red heat to drive off excess ammonium fluoride and burn off the "ZAPON" ring. Allow to cool.
11. Measure the activity on the counting tray using stable α -scintillation equipment [Note (f)].
12. Using a clean counting tray, measure the background of the equipment and correct the counting rate of the sample source for background. [Note (g)].
13. Calculate the concentration of Pu in the sample solution from the relation $\text{Pu (dpm/ml)} = 100 \text{ Ce}_1 / \text{EE}_2 \text{ V}$ [Note (h)].

Notes

- (a) Usually not more than 500 μl should be used.
- (b) After each addition of reagent the mixture should be well stirred with a platinum wire.
- (c) About 0.1 ml of liquid should be left behind at this stage and after each wash to ensure that the precipitate is not disturbed.
- (d) A piece of glass tubing drawn out to a capillary and attached to a rubber teat.

- (e) The precipitate is easily washed from the narrow portion of the tube, but it is difficult to remove it if it is allowed to dry on the wider part of the tube.
- (f) The stability of the counter may be checked statistically using a standard plutonium source (see Appendix II).
- (g) The background should not normally exceed 2 cpm.
- (h) The ratio E_1/E_2 may be replaced by the ratio of the counting rates of the plutonium control source at the time of standardizing and at the time of sample count provided that the same control source is used.

Where C = Counting rate of sample source corrected for background as cpm.
 V = Volume of sample in ml.
 E = Percentage efficiency of the counting equipment for the standard plutonium source (Appendix I).
 E_1 = Percentage efficiency of the counting equipment for the Pu control source at the time of calibration (Appendix I).
 E_2 = Percentage for the Pu control source at the time of sample count (para. 11).

APPENDIX I. Calibration of the α -counting equipment.

Using 500 μ l of the standard Pu solution (0.5 μ g Pu/ml) (see Section B, para. 7) obtain a series of standard sources by the procedures described in Section D, paras. 2 to 10.

Measure the counting rate of each source and correct for background.

Determine the disintegration rate of each source using an α -proportional counter of known efficiency. (This efficiency is measured with a source calibrated in a low geometry counter.)

Calculate in each case the ratio

$$\frac{\text{Corrected counting rate as cpm}}{\text{Disintegration rate as dpm}}$$

and calculate the counter efficiency $E = 100$ mean ratio.

APPENDIX II. Preparation of the Pu control source.

Prepare a standard Pu solution containing about 10 μ g/ml of Pu. Transfer approximately 20 mg of this solution from a weight pipette to a clean prepared counting tray, ensuring that the liquid forms a small spot in the center of the tray. Evaporate the liquid on the tray to dryness by warming gently beneath a radiant heater. Allow the tray to cool and add just sufficient of a solution containing 10 μ g/ml of collodion in acetone to cover the spot of activity. Allow to dry at room temperature. Determine the counting rate of the control source and determine the disintegration rate using an α -proportional counter of known efficiency. Calculate the efficiency of the counting equipment.

$$\text{Efficiency} = \frac{100 \text{ Corrected counting rate (as cpm)}}{\text{Disintegration rate (as dpm)}}$$

NOTE: The procedures of Appendix I and Appendix II are carried out at the same time and E_1 , the efficiency of the equipment for the control source at the time of calibration of the equipment, is obtained. The counting rate of the control source is measured with each set of sample determinations and E_2 , the efficiency of the equipment at the time of sample count, is calculated using the previously obtained disintegration rate.

Procedure 2. Separation and determination of Pu by TTA extraction. F. L. Moore and J. E. Hudgens, Jr. (Ref. 287).

Outline of Method

The sample is pre-treated if necessary, with either HNO_3 or by precipitating LaF_3 and dissolving in $\text{Al}(\text{NO}_3)_3\text{-HNO}_3$. The pre-treatment destroys any polymer which may be present and assures the proper valence state (IV) for the TTA extraction. Pu(IV) is extracted from 2 M HNO_3 and stripped into 10 M HNO_3 , evaporated onto a plate, and counted. Yield is quantitative.

Reagents

Hydroxylamine hydrochloride, 1 M, is prepared by dissolving 69.5 grams of C.P. grade and diluting it to 1 liter.

Sodium nitrite, 1 M, is prepared by dissolving 69 grams of C. P. grade and diluting it to 1 liter.

2-Thenoyltrifluoroacetone-xylene 0.5M, is prepared by dissolving 111 grams of the ketone and diluting it to 1 liter with C. P. xylene. (2-Thenoyltrifluoro acetone may be obtained from Graham, Crowley, and Associates, Inc., 5465 West Division St., Chicago 51, Ill.)

Pretreatment

Nitric acid method. A suitable aliquot of the sample solution is pipetted into a 100-ml volumetric flask containing 13 ml of concentrated nitric acid. The solution is heated carefully to a low boil on a hot plate and the temperature is held just under boiling for 5 min. The solution is then made to a known volume with distilled water. The nitric acid concentration of this solution should be approximately 2M.

Fluoride method. A suitable aliquot (1 ml) of the sample solution is pipetted into a 5-ml centrifuge cone. After addition of 0.4 ml of concentrated hydrochloric acid and 0.1 ml of lanthanum carrier (5 mg per ml) the solution is mixed well. Then 0.3 ml of hydroxylamine hydrochloride (5M) and 0.4 ml of hydrofluoric acid (27 M) are added and the solution is stirred with a platinum stirrer. After a 5-min digestion at room temperature, the solution is centrifuged for 3 min. Next, 0.1 ml of lanthanum carrier (5 mg per ml) is added and the supernatant is stirred, care being taken not to disturb the precipitate. After another 5-min digestion at room temperature, the solution is centrifuged for 3 min and the supernatant is removed with mild suction. The precipitate is washed twice with 0.5-ml portions of 1 M nitric acid - 1 M hydrofluoric acid, centrifuging each time for 3 min. The lanthanum fluoride precipitate containing the Pu is then dissolved in 0.3 ml of 2 M aluminum nitrate and 1 ml of 2 M nitric acid.

This treatment not only aids in depolymerizing Pu(IV) but offers a method of removing the Pu from interferences, as sulfuric acid, before performing the extraction. The liquid-liquid extraction technique described in this paper has been applied successfully for several years to the purification and isolation of Pu isotopes.

Procedure

The choice of the sample size is governed by the magnitude of the concentration of Pu activity and of the beta and gamma ray emitters in the original solution. The presence of high levels of radioactivity must be considered because of the health hazard involved and because a beta ray counting rate of over 10^9 counts per minute will interfere with the alpha counting on the Simpson proportional alpha counter.

One ml of the sample solution (pretreated if necessary) is pipetted into a 10-ml beaker. Three ml of 2 M nitric acid and 1 ml of 1 M hydroxylamine hydrochloride solution are added. The solution is mixed thoroughly and heated at approximately 80°C. for 5 min. The volume of the solution is adjusted to approximately 4 ml by the addition of several drops of 1 M nitric acid. The solution is transferred to a 30-ml separatory funnel using 2 ml of 1 M sodium nitrite, mixed thoroughly and allowed to stand until gas evolution ceases. The aqueous phase at the time of extraction should be approximately 1 M in nitric acid.

The solution is extracted for 10 min with an equal volume of 0.5 M 2-thenoyltrifluoroacetone-xylene. When the two phases have disengaged, the aqueous phase is drawn off and discarded. The organic phase is washed by mixing with an equal volume of 1 M nitric acid for 3 min. After the phases have settled, the aqueous wash solution is discarded, care being taken not to lose any of the organic phase. The Pu is then stripped from the organic phase by mixing thoroughly for 2 min with an equal volume of 10 M nitric acid. If the aqueous strip solution is too high in gamma radioactivity for alpha measurement, the last traces of radiozirconium and protactinium may be removed readily by a 5-min re-extraction of the 10 M nitric acid strip solution with an equal volume of 0.5 M 2-thenoyltrifluoroacetone-xylene. Pu remains quantitatively in the aqueous phase. The small percentage of iron extracted (produces a red color) remains in the organic phase when the Pu is stripped into 10 M nitric acid. The aqueous strip solution is drawn off into a centrifuge tube and centrifuged for 1 min. A suitable aliquot is pipetted onto a platinum (or stainless steel) plate and evaporated to dryness under an infrared heat lamp. The plate containing the evaporated sample aliquot is heated to a dull red heat over a Fisher burner to destroy organic matter and counted in a suitable alpha counter. In this laboratory, the methane flow proportional alpha counter is used almost exclusively.

Procedure 3. Separation and determination of Pu in U – fission product mixtures.

W. S. Maeck, G. L. Booman, M. E. Kussy and J. E. Rein (Ref. 261).

Outline of Method

Plutonium is oxidized to Pu(VI) with permanganate and quantitatively extracted as a tetraalkylammonium complex into methyl isobutyl ketone from an acid-deficient aluminum nitrate salting solution. Pu is stripped from the organic phase and reduced to Pu(III) with a hydroxylamine-iron(II) mixture, oxidized to Pu(IV) with nitrite, then quantitatively extracted into TTA.

Yield

Overall recovery of Pu is 98.8%.

Decontamination

Overall fission product decontamination is greater than 1×10^4 ; U carry-through is less than 0.05%.

Reagents

Reagent grade inorganic chemicals, Eastman Kodak Co. White Label tetrapropylammonium hydroxide, and thenoyltrifluoroacetone obtained from Peninsular Chemical Research, Inc., Gainesville, Fla., were used without purification.

Aluminum nitrate salting solution. Place 1050 grams of aluminum nitrate nonahydrate in a 2-liter beaker and add water to a volume of 800 ml. Warm on a hot plate. After dissolution, add 135 ml of concentrated (14.8 N) ammonium hydroxide and stir for several minutes until the hydroxide precipitate dissolves. Cool below 50°C. Add 50 ml of 10% tetrapropylammonium hydroxide reagent and stir until dissolution is complete. Transfer to a 1-liter volumetric flask and dilute to volume with water.

The 0.2 M ferrous sulfate and 0.22 M sodium nitrite solutions should be prepared fresh daily. The 1.25 M hydroxylamine hydrochloride and 0.05 M potassium permanganate solutions are stable for a month or longer. The potassium permanganate solution is stored in a dark bottle.

Unless otherwise stated, the Pu levels in extractions were approximately 100,000 disintegrations per min (dpm). The stock solution was prepared from high purity Hanford metal dissolved in 6 N hydrochloric acid. The isotopic composition of the metal was 95.40% Pu²³⁹, 4.31% Pu²⁴⁰, 0.28% Pu²⁴¹, and 0.01% Pu²⁴².

Equipment

The methyl isobutyl ketone (4-methyl-2-pentanone) extractions and strips were made in 15 × 125 mm test tubes with polyethylene stoppers. An end-for-end extraction wheel was used. Thenoyltrifluoroacetone extractions were made in 50 ml centrifuge cones with a motor-driven wire stirrer. The samples plates were 1-in.

stainless steel. An alpha scintillation counter was used for gross counting and a Frisch grid chamber, 256-channel analyzer system, for pulse height analysis.

Procedure.

Add 6 ml of salting solution to a test tube containing 0.1 ml of 0.05 M potassium permanganate. Pipette 1 ml or less of sample into the tube. Add 3 ml of methyl isobutyl ketone, stopper the tube, and extract for 5 min on the extraction wheel. Centrifuge to facilitate phase separation. Pipette 3 ml of 3.125M nitric acid, 2 ml of 1.25 M hydroxylamine hydrochloride, and 2 ml of the above organic phase into another 15 X 125 mm test tube. Stopper the tube and strip for 10 min, and then centrifuge. Carefully transfer 2 ml of the aqueous strip phase to a 50-ml centrifuge tube containing 0.1 ml of freshly prepared 0.2 M ferrous sulfate and allow the mixture to stand for 5 min. Add 3 ml of freshly prepared 0.22 M sodium nitrite and let stand until gas evolution ceases. Add 5 ml of 0.5 M thenoyltrifluoroacetone-xylene and stir vigorously for 20 min. Remove an aliquot of the organic phase and dry on a planchet under a heat lamp. Ignite and count.

Procedure 4. Plutonium R. J. Morrow (Ref. 293)

Outline of Method

The Pu is co-precipitated from acid solution with $\text{La}(\text{OH})_3$ with NH_4OH . The precipitate is washed with NaOH solution, dissolved and the co-precipitation repeated using $\text{La}(\text{IO}_3)_3$ as the carrier. The hydroxide precipitation is repeated and the Pu adsorbed on an anion resin column from 8 M HNO_3 . The column is washed successively with HNO_3 and 2 portions of 10 M HCl. Finally, the Pu is eluted with a mixture of HCl and HI and mounted for counting.

Purification

This procedure is designed primarily for separation of Pu samples to be alpha-counted; it does not yield samples highly purified from beta- and gamma-emitters. Samples containing 10^{13} - 10^{14} atoms of Pu have been isolated from four-day old solutions of 5×10^{13} fissions. No foreign alpha activities could be detected, and the beta content was 10^5 dpm or less.

Yield

60% if an electroplating technique is used for the final step, and 35% if vacuum volatilization is used.

Procedure

One operation can do 12 samples in 6 hours, exclusive of volatilization or electroplating.

1. To an acid solution of mixed activities in a plastic centrifuge cone add ~ 1 mg La^{+3} carrier and an appropriate amount of standardized Pu alpha-emitting tracer, the isotope added and its level of activity depending upon the isotope sought and its estimated level of activity. Add 2-3 drops sat. NaNO_2 solution and heat in a hot-water bath for five minutes.
2. Add enough conc. NH_4OH to make the solution basic. Stir, and digest at 60°C in a hot-water bath for five minutes. Centrifuge and discard supernatant solution.
3. To the precipitate add 5 ml 25% NaOH solution. Stir and digest for 5 min at 60°C in a hot-water bath. Centrifuge and discard the supernatant solution.
4. The hydroxide precipitate is then dissolved in a minimal volume of 3 M HCl and a volume of 0.5 M HIO_3 is added of the order of 4-5 times the volume of HCl solution.
5. The precipitate is then digested for 10 min in a hot water bath.
6. The sample is centrifuged and the supernatant solution is decanted, after which the precipitate is washed with 0.1 M HIO_3 .
7. The sample is again centrifuged and the supernatant solution decanted.

8. A minimal amount of concentrated HCl is used to dissolve the precipitate with stirring.
9. After dissolution the sample is precipitated with sodium hydroxide and centrifuged.
10. The supernatant solution is discarded and the precipitate is washed with H₂O and centrifuged after which the supernatant solution is again discarded.
11. To precipitate, add enough 8 N HNO₃ saturated with H₃BO₃ (usually ~5-10 drops) to dissolve. Heat in hot-water bath if necessary.
12. Pipet the solution onto a 3 mm i.d. X 6 cm long Dowex A-1 (1 X 8) anion exchange resin column (previously washed thoroughly with 8 N HNO₃) and discard effluent. Wash column twice with 2 ml 8 N HNO₃ each time, and twice with one ml portions of 10 N HCl. Discard all washes.
13. To column add 2 ml of a solution 10 N in HCl and 0.5 N in HI, collecting eluate in a 50 ml Erlenmeyer flask or a 40 ml centrifuge tube.
14. Either of two alternatives may now be followed:
 - a. Boil the solution to a very small volume and pipet the remainder onto the central depression of the tungsten filament of vacuum bell jar apparatus. Carefully boil the remaining solution to dryness in the filament in air by application of current through filament. Evacuate system and flash the contents of the filament onto a platinum disc located about 1/4 in. - 1/2 in. from filament.
 - b. Evaporate the solution to dryness and redissolve residue with three drops of conc. HCl. Transfer to an electrolysis cell suitable for 1-in. diameter plates. Rinse tube successively with three more drops of conc. HCl and three drops of water adding the rinses to the solution in the cell. Carefully adjust acidity to the methyl red end point with conc. NH₄OH, then make barely acidic with two drops of 2 M HCl. With a 1-in. Pt disc as cathode, and a volume of roughly 1 to 2 ml, plate at 5-6 volts with about 2.5 amps for roughly fifteen min. Before stopping the current, add 1 ml conc. NH₄OH. Shut off current, remove solution and wash the disc first with water, then with acetone. Mild flaming of the plate is desirable.

Procedure 5. Plutonium D. C. Hoffman (Ref. 185)

Outline of Method

The essentially specific procedure for Pu utilizes the almost quantitative carrying of Pu(IV) on lanthanum fluoride and also the great difference in ability of Pu(III) and Pu (IV) in 12 M HCl medium to be absorbed on a Dowex A-1 anion resin. One cycle of the procedure serves to separate Pu from other α -emitters, and two cycles usually gives complete decontamination from β -emitting fission products.

The initial lanthanum fluoride precipitation, carried out in the presence of hydroxylamine, is an excellent volume-reducing step and also eliminates many elements (notably iron) which may interfere in the subsequent adsorption of Pu on the resin column. After dissolution of the lanthanum fluoride precipitate in 12 M HCl, adsorption on the anion resin column of Np, Pu, and any traces of Fe and U present is effected, while the rare-earths Am and Cm pass through the column. Pu is eluted from the column after reduction to Pu(III) with hydriodic acid; Np is not reduced to the +3 state and remains quantitatively behind. (A solution containing 15 μ g of U²³⁵ was run through the procedure, and no fission counts above the usual background of 0.1 - 0.2 smidgins (1 smidgin = 10^{-6} mg) could be detected.)

The Pu is collected directly from the resin column on 2-in. Pt plates which are flamed, α -counted, and, if necessary, pulse-analyzed. The plates are usually very clean and may be α -pulse-analyzed with a resolution of 1 - 1.5%.

Samples are usually run in quadruplicate and yields are determined in one of two ways. Pu²³⁶ tracer to the extent of about one-fourth to one-half of the total Pu α -activity expected may be added to one or two of the original aliquote. On completion of the analysis, the fraction of Pu²³⁶ in the sample is determined by pulse analysis, thus permitting the calculation of yield. Yields may also be determined by spiking two of the four samples with a standardized solution of Pu activity which is at least five times as active as the aliquot to be analyzed. The average of the number of cpm in the two unspiked samples is subtracted from the average in the two spiked samples. The resulting value divided by the number of cpm in the spike gives the yield. The chemical yield is usually about 97% and for a set of four aliquots analyzed simultaneously is constant to within $\pm 1\%$. In analysis of solutions of very high ionic strength the yields are somewhat lower (90-97%), probably because under these conditions the lanthanum fluoride carrying step is less efficient. Quadruplicate analyses can be performed in 3 h.

Reagents

La carrier: 5 mg La/ml (added as $\text{La}(\text{NO}_3)_3 \cdot 6\text{H}_2\text{O}$ in H_2O)

Pu²³⁶ standardized tracer solution (in 3 N HCl),

or

Pu standardized spike solution (any mixture of Pu isotopes in 3 N HCl).

HCl: conc. (12 M)

HCl: 3 M

HF: conc.
HF-HNO₃: equal volumes of 2 M solutions
H₃BO₃: saturated solution
NH₂OH·HCl: 35% by weight in H₂O
Solution I: 0.1 ml conc. HNO₃ per 15 ml conc. HCl
Dowex A-1 (10% cross-link, Nalcite SBR) anion resin slurry in H₂O.

Preparation

The 200-400 mesh moist solid is washed about three times with successive portions of water and conc. HCl. After each wash the resin is allowed to settle and the liquid decanted by siphoning or by means of a vacuum pipet. The resin is then stirred thoroughly with several times its volume of water in a large graduated cylinder, and the following fractions are withdrawn on the basis of sedimentation rates: < 1 cm/min, < 5 cm/min, < 10 cm/min and > 10 cm/min. The < 10 cm/min fraction is employed in the procedure.

HI stock solution. Distill HI (Mallinckrodt analytical reagent grade, 5.5 M in HI, 1.5% H₃PO₂ preservative) under nitrogen. The HI cannot be used without distillation, since the H₃PO₂ preservative appears to cause the eluted drops to attack the Pt collection disks and make the samples unsuitable for pulse analysis. Commercial preparations of HI without preservative usually contain enough free iodine to make them unsuitable. Even after storage under nitrogen, distilled HI is slowly oxidized. Oxidation is inhibited by the addition of sufficient hydrazine (up to 20% by volume of 64-84% N₂H₄ in H₂O) to decolorize the HI solution. The final solution is about 4.4 M in HI.

HI-HCl elutriant. 1 ml of HI stock solution is added to 9 ml of conc. HCl to give a solution about 0.44 M in HI. The precipitate which results from the hydrazine present is removed by centrifugation and the supernate is saturated with gaseous HCl. The solution is permitted to come to equilibrium at room temperature before use and since the solution is readily oxidized, fresh reagent is required every few days.

Equipment

Centrifuge
Block for holding centrifuge tubes
Fisher burner
Heat lamp
Pt disks: 2 in. diameter
Pt wire stirring rods
Transfer pipets and syringes
Vacuum trap for withdrawing supernates (optional)
10-cm glass ion exchange columns (see Note 4, Np procedure) (one per sample)
40-ml conical centrifuge tubes: Pyrex 8140 (one per sample)

Procedure

Step 1. Pipet the samples (2 M in HCl or HNO₃) into 40-ml long taper conical centrifuge tubes. (1-ml aliquots are used if possible, although aliquots as large as 25 ml can be taken if necessary). If tracer or spike is added to 1 or 2 of the samples, make the others up to the same volume with a solution of acid strength identical to that of the tracer or spike. Stir.

Step 2. Add 1-2 drops of La carrier and then 2-4 drops of NH₂OH·HCl per ml of solution. Make the solution at least 2.5 M in HF by addition of conc. reagent (Note 1). Agitate the solution and permit to stand for 5 min after the addition of each of the above reagents.

Step 3. Centrifuge and discard the supernate.

Step 4. Wash the precipitate with about 0.5 ml of 2 M HF-2 M HNO₃ solution. Stir, centrifuge and discard the supernate.

Step 5. Dissolve the LaF₃ precipitate by adding 1 drop of saturated H₃BO₃ solution, stirring, and then adding conc. HCl to a volume of 1.5-2.0 ml. The solution may be warmed if necessary.

Step 6. Transfer the solution to a 5-cm Dowex A-1 resin column (see Note 4 of Np procedure) which has been washed with 1-2 column volumes (Note 2) of Solution I (Note 3). Wash the centrifuge tube with two 1-ml aliquots of Solution I. The washes may be driven through the column with air pressure if so desired. The effluent solutions from these washes may be used for the Am and Cm determinations; if not to be so used the washes are discarded.

Step 7. Wash the sides of the centrifuge tube with 1.5 ml of conc. HCl, wash and remove the Pt stirring rods, centrifuge and pass the solution through the column with the use of pressure.

Step 8. Add a few crystals of NH₂OH·HCl directly to the top of the resin column. (This helps to prevent immediate oxidation of the HI solution by any traces of HNO₃ remaining on the column.) Wash the centrifuge tube with 1.5 ml of conc. HCl, transfer the washings to the column, and permit them to pass through. The column should not be permitted to run dry while air pressure is being applied to it, since air bubbles will be forced into the column and channeling and erratic elution of activity may occur.

Step 9. 1-2 ml of the HI-HCl elutriant is put on the top of the column and no pressure is applied during elution. The dark band of the elutriant may be seen migrating down the column. The activity appears to be concentrated about the lower edge of the elutriant band and most of it comes off in a 6- to 8-drop peak. However, to obtain quantitative yields, drop collection is begun on a 2-in. Pt disk when the band is about 0.8 cm from the end of the column, and collection is continued for 10-15 drops after the band has reached the end of the column. This allows for possible irregularities in the band or misjudgements regarding its position. The drops taken before the band reaches the end of the column are arranged on the periphery of the Pt disk, and those which are expected to contain most of the activity are collected near the center. The drops are not permitted to run together.

Step 10. Place the Pt disk under a heat lamp and allow the drops to evaporate. Heat the plate to red heat in an open flame and cool; α -count if the original aliquot was spiked, and pulse analyze and α -count if Pu²³⁶ tracer was employed (Notes 4 and 5).

Notes

1. When an appreciable quantity of Fe is present, enough HF must be added not only to complex this element (thus decolorizing the solution) but also to precipitate La carrier.
2. The column volume is defined as about one-half the volume calculated from the actual dimensions of the column. The column volume may, of course, be measured experimentally in each case if the interfaces can be clearly seen.
3. The presence of conc. HNO₃ in Solution I is necessary to destroy the reducing properties of the original resin and thus avoid premature reduction of Pu(IV) to the tripositive state.
4. If it is desired to fission count the Pu, plates may be prepared by taking the activity directly from the column. However, if any drops are permitted to run together giving an extreme "bathtub effect," the fission counting results are invariably too low. To avoid such effects attributable to sample thickness, the following procedure for plate preparation is employed.

The Pu activity is evaporated on a 1-mil W filament under a heat lamp, but the filament is not flamed. It is then placed in a vacuum evaporating apparatus constructed at this Laboratory. The chamber of the apparatus is evacuated to 5×10^{-4} mm or less of Hg pressure and the filament is heated rapidly several times to about 1300°C to remove readily volatile material. A 1-in. diameter collector plate is then placed in position directly above the sample (1/4 to 1/2-in. away) and the filament is heated to 2000°C for a few seconds to volatilize Pu. The Pt disk is then flamed and mounted for fission counting. The yields vary, depending upon the size of the sample being evaporated and also upon the distance between the filament and the disk, but are usually about 40%. By careful control of the W filament temperatures, plates having no visible deposit and checking to within 0.1% are ordinarily obtained.

5. The Np activity which quantitatively remains on the column after elution of Pu may be removed in the following manner:

Step 1: By means of pressure, run conc. HCl containing several drops of HNO₃ per ml through the column until the dark color has been removed. Discard the effluent. (During this process the column may separate as a result of bubbling, etc., but can be resettled by means of pressure.)

Step 2. Wash the resin with conc. HCl and pressure, permitting the column to rebed itself.

Step 3. Elute the Np with 0.1 N HCl. If the yield is very low after only one elution with 0.1 M HCl, about three cycles of elution alternately with 0.1 M HCl and conc. HCl usually give yields up to 85%.

Procedure 6. Separation of Plutonium from Uranium and Fission Products in Irradiated Reactor Targets R. G. Hart, M. Lounsbury, C. B. Bigham, L. P. V. Corriveau, F. Girardi (Ref. 167)

Outline of Method

The Pu is adsorbed on anion exchange resin (Dowex 1) from 7-11 M HNO₃, the U and most of the fission products passing through. The Pu is then eluted by reduction with 1 M NH₂OH·HNO₃ and impurities are extracted into TBP while the Pu remains as Pu(III). The Pu is then precipitated as the hydroxide, dissolved in HNO₃ and extracted into TBP. Finally, the Pu is back-extracted by NH₂OH·HNO₃, precipitated as hydroxide, and dissolved in HNO₃ for analysis.

This procedure describes two specific types of analyses to be done on dissolved, irradiated, U targets. These are (1) isotopic dilution by Pu²⁴⁰ followed by mass spectrograph analysis, and (2) isotopic dilution by Pu²³⁸ followed by α pulse analysis. These analyses are described before the separation procedure is given.

Procedure

Total Pu, isotopic dilution with Pu²⁴⁰. Two aliquots, one containing ~ 800 μ g of Pu and the other containing ~ 400 μ g of Pu, are removed from the dissolver solution. Only the second aliquot need be measured accurately. To the second aliquot is added ~ 400 μ g of Pu containing a high percentage of the heavier isotopes. This aliquot must be accurately measured and the Pu concentration and isotopic composition must be accurately known. The samples are allowed to stand for 4 or 5 days to allow the spiked sample to reach isotopic equilibrium¹ and are then carried through the Separation procedure. The purified Pu is then mass analysed. From the isotopic compositions of the standard, the unknown and the mixture, and the total Pu content of the standard, it is possible to calculate the total Pu concentration in the unknown.

Total Pu, isotopic dilution with Pu²³⁸. Two aliquots, one containing ~ 100 μ g of Pu and the other containing ~ 50 μ g of Pu, are removed from the dissolver solution. Only the second need be measured accurately. To the second aliquot is added ~ 0.19 μ g of Pu²³⁸. This aliquot must be accurately measured and the Pu²³⁸ disintegration rate of the solution must be accurately known. Both samples are diluted to 15 ml with 7 M nitric acid, and are allowed to stand for 4 or 5 days to allow the spiked sample to reach isotopic equilibrium.² The two samples are now carried through the Separation method and α -counting discs are prepared from each as described in the following section. From the ratios of Pu²³⁸ to Pu²³⁹ in the spiked and unspiked samples, the total disintegration rate of the standard Pu²³⁸ solution, and the isotopic composition of unspiked sample, it is possible to make an accurate calculation of the total Pu content of the solution.

¹No detailed study has been made to determine the length of time required to reach isotopic equilibrium, but it is known that some considerable time is necessary.

²See Footnote 1.

Preparation of α -counting plates. An aliquot containing about 50 μg of U was transferred to a stainless steel source tray in the usual manner. The micropipette used was then washed three times with a solution of tetraethylene glycol (TEG) in dilute nitric acid (4 drops of TEG in 10 ml of 1 M nitric acid). The solution on the source tray was then evaporated to dryness under an infrared lamp and the disc was ignited to redness. The evaporation must take place very slowly to avoid decomposition of TEG by hot nitric acid. Two to three hours are necessary for the drying.

Separation procedure

- (1) The aliquot, in 7-11 M nitric acid, was passed through a 1-ml column of 250-mesh Dowex 1 in the nitrate form to absorb the anionic Pu nitrate complex.
- (2) The uranium and fission products were washed through the column with 20 ml of 7.5 M nitric acid. The strong acid was then displaced with 1 ml of 1 M nitric acid.
- (3) An aliquot of the effluent containing ~ 40 mg of U was retained for U isotopic analysis and the remainder was discarded.
- (4) The Pu was eluted from the column with 4 ml of 1.0 M hydroxylamine nitrate.
- (5) The Pu solution was extracted five times with 2 ml portions of 30% TBP-soltrol to remove any U left with the Pu.
- (6) The Pu was precipitated from the aqueous phase with concentrated ammonium hydroxide, dissolved in 100 λ of concentrated nitric acid, diluted to 0.5 ml and extracted with two 0.5-ml portions of 30% TBP-soltrol.³
- (7) The Pu was then backwashed from the organic phase with 3 half-volume 1 M hydroxylamine nitrate washes, precipitated with ammonium hydroxide, washed once with water, and dissolved in 20 λ of concentrated nitric acid. The solution was then diluted to 100 λ with 1 M nitric acid.

³The TBP extraction is necessary to separate the plutonium from resin decomposition products.

Procedure 7. Determination of Pu (Ref. 447)

Outline of Method

This procedure used an oxidized CeF_4 -reduced LaF_3 cycle and extraction of Pu(VI) into hexone, in addition to two cycles of adsorption of Pu(IV) on anion resin from concentrated HCl and desorption by reduction with NH_4I .

Procedure

1. Add 5 mg Fe^{+++} and 1 ml HNO_3 to the acid solution containing the Pu activity. Boil the solution down to about 3 ml and transfer to a 50-ml lusteroid tube.
2. Make the solution ammoniacal to precipitate $Fe(OH)_3$. Digest for a few minutes on a 75°C water bath. Wash the hydroxide with 5 ml water containing 1 drop NH_4OH . Discard the supernate and wash.
3. Dissolve the $Fe(OH)_3$ in 3 drops HNO_3 and dilute with water to a volume of 15 ml (Note a). Add 3 mg Ce^{+++} and 2 granules of $Na_2Cr_2O_7$. Stir well and heat for 5 min on a 75°C water bath. Cool in tap water until sample reaches room temperature.
4. Precipitate CeF_4 by adding 10 drops HF treated with dichromate (Note b). Stir well and centrifuge immediately. Wash the precipitate with 2 ml 1 N HNO_3 · 1 N HF. Decant the supernate and wash into a clean 50-ml lusteroid tube.
5. Make the solution basic with 8 N NaOH. Let stand 3 min and centrifuge. Wash the $Fe(OH)_3$ with 10 ml water. Discard the supernate and wash. Dissolve the hydroxide in 3 drops of HNO_3 .
6. Add 5 mg La, 1 mg of Zr and dilute to 10 ml with water. Heat the solution for 3 min on a 75°C water bath. Add 20 mg $NaHSO_3$ a little at a time, to insure complete reduction. Continue to heat for 5 min. Add 10 drops HF with stirring, and heat for a few minutes. Cool and centrifuge. Wash the LaF_3 with 2 ml 1 N HCl · 1 N HF. Discard the supernate and wash.
7. Slurry the LaF_3 in 1 ml saturated H_3BO_3 and heat on a 75°C water bath for a few minutes. Add 1 ml HCl and 1 ml water and continue to heat on the water bath to obtain a clear solution. Transfer the solution to a 40-ml glass tube with water washes.
8. Add NH_4OH to precipitate $La(OH)_3$. Digest in a hot water bath for a few minutes. Centrifuge, and wash the precipitate with 5 ml water containing 1 drop NH_4OH . Discard the supernate and wash.
9. Dissolve the $La(OH)_3$ in 1 ml HCl and 2 drops HNO_3 . Heat the solution for 3 min in a hot water bath. Cool the solution in an ice bath, and saturate with HCl gas. Allow to come to room temperature.
10. Transfer the solution to a prepared Dowex AG 1-X8 (100-200 mesh) column. Prepare a wash solution containing 15 ml HCl and 1/2-ml

- HNO_3 . Rinse the tube with several 1-ml portions of this solution. Transfer these washes to the column. Wash the column with the remaining solution in 2-ml portions. Wash with 15 ml HCl in 2-ml portions. Discard the effluents and washes.
11. Prepare an eluting solution containing 20 ml HCl and 75 mg NH_4I . Elute the Pu from the column into a 50-ml beaker with 2-ml portions of this solution, allowing the first 2-ml portion to pass through. Add the second 2-ml portion and plug the top of the column with a piece of pressure-sensitive tape for 5 min. Remove the tape and continue to elute in 2-ml portions. Pass through 6 ml of HCl in 2-ml portions.
 12. Add 2 mg of La and evaporate the solution to approximately 5 ml. Transfer to a 50-ml lusteroid tube and dilute to a volume of 10 ml. Add 20 mg NaHSO_3 a little at a time.
 13. Add 10 drops HF with stirring, and allow to stand for a few minutes. Cool in an ice bath, centrifuge, and wash the LaF_3 with 2 ml 1 $\underline{\text{N}}$ HCl \times 1 $\underline{\text{N}}$ HF . Discard the supernate and wash.
 14. Repeat Steps 7 through 11.
 15. Evaporate the solution in the 50-ml beaker to approximately 5 mls with addition of HNO_3 to drive off all iodine. Transfer the solution to a 40 ml centrifuge tube.
 16. Add 5 mg Fe^{+++} and precipitate $\text{Fe}(\text{OH})_3$ by addition of NH_4OH . Digest in a hot water bath for a few minutes. Centrifuge, and wash the precipitate with 5 ml water containing 1 drop NH_4OH . Discard the supernate.
 17. Dissolve the $\text{Fe}(\text{OH})_3$ in 5 ml 6 $\underline{\text{N}}$ HNO_3 . Add 4 drops saturated NaBrO_3 solution. Warm on a hot water bath for a few minutes. Saturate the solution with NH_4NO_3 crystals, add 5 ml hexone (methyl isobutyl ketone) and stir with a mechanical stirrer for 3 min. Centrifuge to separate the phases, and withdraw the hexone (upper) layer with a transfer pipet. Transfer the hexone to a clean, dry 40-ml centrifuge tube. Repeat the extraction twice, adding 1 drop of saturated NaBrO_3 and more NH_4NO_3 if necessary.
 18. Record the time of extraction as the "Final Separation of Pu^{241} and Am^{241} ."
 19. Wash the hexone phases by stirring with 5 ml 6 $\underline{\text{N}}$ HNO_3 . Stir for 2 min, centrifuge, withdraw the acid (lower) phase and combine with original aqueous phase.
 20. Back-extract the Pu from the hexone by stirring for 3 min with 5 ml 0.1 $\underline{\text{N}}$ HNO_3 . Centrifuge, and transfer the aqueous phase into a 50-ml beaker. Repeat twice and combine the aqueous phases.
 21. The solution is now ready for electroplating.

Notes

- a. Do not continue step 3 unless there is enough time to carry the procedure completely and rapidly through step 5.
- b. Dissolve 1 granule of $\text{Na}_2\text{CR}_2\text{O}_7$ with 1/2 ml HF in a Pt dish.

Procedure 8. Uranium and Plutonium Analysis B. F. Rider, et al., (Ref. 332)

Outline of Method

Sample of dissolved irradiated fuel contain highly radioactive fission products. For this reason, U and Pu are separated before analysis. The procedure described here gives a good yield, together with a good decontamination factor.

Reagents

1. Distilled conc. HNO_3 .
2. 2 M HNO_3 - distilled conc. HNO_3 , double distilled H_2O .
3. U^{233} solution, standardized.
4. Pu^{236} solution, standardized.
5. KBrO_3 - crystals, reagent grade. Low natural U blank.
6. 8 M NH_4NO_3 in 2 M HNO_3 - Place 200 ml distilled 16 M HNO_3 + 100 ml double distilled H_2O in a large beaker. Bubble NH_3 gas through solution until basic to pH paper. Boil off excess NH_3 (solution neutral). Transfer to mixing cylinder, add 50 ml of distilled 16 M HNO_3 , dilute to 400 ml. Check density of solution (1.31 ± 0.01 @ 20°C).
7. Hexone - distilled.
8. HCl - C.P. reagent. Low natural U blank.
9. 1 M HNO_3 - distilled conc. HNO_3 , double distilled H_2O .
10. 30% H_2O_2 - meets A. C. S. specification, low natural U blank.
11. 0.2 M TTA in xylene - 4.44 gm TTA dissolved in 100 ml distilled xylene.
12. Xylene - distilled.
13. Ether - distilled.
14. 0.05 M HNO_3 - distilled conc. HNO_3 , double distilled H_2O .
15. H_2O - double distilled.

Glassware

All glassware used is Pyrex which has been soaked overnight in 50% HNO_3 and rinsed with double distilled water. Pipets are rinsed with 50% HNO_3 and double distilled water before being used.

Separation and Decontamination Procedure

1. Place the aliquot for analysis in a 15-ml cone and evaporate to about 1 ml. Add a suitable U^{233} and Pu^{236} spike, one drop conc. nitric acid, and several KBrO_3 crystals. Allow to stand for 1 hr to allow oxidation of Pu to PuO_2 .
2. Add 1.5 ml 8 M NH_4NO_3 in 2 M HNO_3 , and evaporate to about 2 ml.
3. Prepare two scrub solutions in separate 15-ml cones, containing 1 ml of 8 M NH_4NO_3 in 2 M HNO_3 and about 10 mg KBrO_3 . Preoxidize about 10 ml Hexone with 2 ml of 2 M HNO_3 and KBrO_3 . Keep covered until ready for use.

4. Extract the U and Pu four times for 5 min with 2-ml portions of hexone (methyl isobutyl ketone), adding 1 drop of 16 M HNO_3 to the original solution after each extraction. Scrub each extract in turn with the two solutions prepared in step 3.
5. Strip the combined hexone extracts with five 2-ml portions of H_2O . Evaporate the combined aqueous portions to dryness, add a few drops of HNO_3 and HCl , take to dryness. Evaporate to dryness with HNO_3 under a gentle stream of pure nitrogen on a boiling water bath.
6. Prepare 3 ml of 1 M HNO_3 and 1 drop of 30% H_2O_2 , add 1 ml to the Pu and U residue from step 5 and two 1-ml portions to separate 15 ml cones.
7. Extract immediately the Pu two times for 20 min with 2-ml portions of 0.2 M TTA (thenoyltrifluoroacetone) in xylene. Scrub each in turn with solutions prepared in step 6. Save the aqueous phase for U. Combine the TTA extracts and add a few crystals of trichloroacetic acid.
8. Mount the combined TTA extracts on a Pt plate for α -pulse analysis.
9. After pulse analysis, remove the Pu for mass analysis as follows: Cover disk with HF. Evaporate to dryness under a heat lamp. Again cover disk with HF and evaporate to dryness. Cover disk with conc. HNO_3 and evaporate to dryness. Repeat three or four times. Cover disk with conc. nitric, reflux a few seconds, and transfer with a pipette to a 15-ml cone. Repeat three or four times.
10. Evaporate the combined conc. HNO_3 refluxes to dryness. Treat residue with aqua regia and evaporate to dryness. Evaporate to dryness with conc. HNO_3 on a boiling water bath several times. Add 50 λ of 0.01 M HNO_3 to the evaporated sample and submit sample for mass spectrographic analysis.
11. Wash the original 1 M HNO_3 U fraction (step 7) with xylene. Add 1 drop of HNO_3 and 3 drops of HCl to the washed 1 M HNO_3 and reflux for about 1/2 hour to destroy the organic present. Evaporate to dryness, flame gently to destroy organic matter and dissolve the residue with 2 drops of HNO_3 and evaporate to dryness on a water bath.
12. Pipette three 1-ml portions of 8 M NH_4NO_3 in 2 M HNO_3 , dissolve the evaporated U fraction in one 1-ml portion. Place the other 2 portions in two 15-ml cones for scrub solutions.
13. Extract the U with four 2-ml portions of diethyl ether, adding 100 λ of conc. HNO_3 before each extraction. Scrub each extract in turn with two scrub solutions prepared in step 12.
14. Evaporate the combined ether extracts over 1 ml of H_2O in a 15-ml cone. Evaporate to dryness.

15. Add 3 drops of HCl and 1 drop of HNO₃, and evaporate to dryness repeatedly until the organic is destroyed. Flame gently to expel ammonium salts. Then dissolve in HNO₃ and evaporate to dryness on a water bath. Add 50 λ of 0.05 M HNO₃ to the dry cone and submit sample for mass spectrographic analysis.

Plutonium Calculation

To determine the amount of Pu in the original sample, it is necessary to measure in a Frisch chamber the α spectrum of the plate prepared in step 8. The ratio of Pu²³⁹ and Pu²⁴⁰ activity to Pu²³⁶ activity is calculated. If the ratio is multiplied by the original activity of Pu²³⁶ added, the original activity of Pu²³⁹ plus Pu²⁴⁰ can be obtained. From the mass analysis a Pu²³⁹ to Pu²⁴⁰ atom ratio is obtained. The specific activity of the mixture is calculated from that of the individual isotopes. The Pu²³⁹ plus Pu²⁴⁰ activity can be converted to Pu²³⁹ plus Pu²⁴⁰ weight by dividing this activity by the specific activity of the mixture.

Uranium Calculation

The ratio of the various U isotopes to U²³³ from the mass spectrometer data is multiplied by the amount of U²³³ spike originally added to the sample to obtain the amount of each U isotope present in the original sample.

Procedure 9a. Separation of Plutonium from Irradiated Uranium R. O. Lingjaerde
(Ref. 255)

Outline of Method

The Pu, U and fission products are adsorbed on a cation exchange column from 0.3-0.5 M HNO₃ and washed with 0.5 M HNO₃. The U and fission products are then eluted with 2.0 M HCl, and the Pu is stripped with 8 M HCl. The Pu is then adsorbed onto anion exchange resin, washed with 8 M HCl, and finally stripped with 2 M HCl.

Procedure

5 ml of stock solution (containing about 15 μ g Pu), 5 ml of 4.0 M HNO₃ and 5 ml of 1.0 M NaNO₂ were mixed in a flask, and made up to a volume of 50 ml with water. NO₂⁻ reduces Pu(VI) to Pu(IV). Care has to be taken that concentration of HNO₃ is not allowed to fall below 0.1 M, since Pu then will hydrolyse and consequently coagulate on the column.

This solution was adsorbed on Dowex 50 (140-160 mesh) and the column was washed with 0.5 M HNO₃. Then 2.0 M HCl was applied to elute U and accompanying fission products. The washing with 2.0 M HCl was continued until the β -activity was close to background.

Pu and remaining fission products were eluted with 8 M HCl, a small amount of concentrated HNO₃ + some NaNO₂ added (to oxidize Pu(III) to Pu(IV)), and this fraction was transferred to another column containing Dowex 1 (50-100 mesh), which beforehand had been washed with concentrated HCl containing a little concentrated HNO₃.

After the sorption step, the column was washed with 8 M HCl (containing a little concentrated HNO₃) until the effluent was practically free from β -activity. Finally the Pu was eluted with 2.8 M HCl.

Procedure 9b. Separation of Plutonium from Uranium Metal. J. Rydberg (Ref. 341)

Outline of Method

This procedure makes use of the co-precipitation properties of the different oxidation states of Pu on BiPO_4 . The Pu is first oxidized to Pu(VI) which does not carry on BiPO_4 , and then reduced to Pu(IV) which carries. An additional purification step is provided by extraction into TTA. Yield is greater than 60%.

Procedure

1. The U sample is dissolved in hot conc. HNO_3 and kept at 90°C for 30 min, giving a solution of U(VI) and Pu(IV).
2. The solution is diluted to 5 M in HNO_3 and solid NaBiO_3 is added to oxidize Pu to the +6 valency state.
3. The solution is made 0.1 M in HNO_3 (if it becomes turbid, HNO_3 is added until the solution is clear) and 0.1 M in phosphate. The BiPO_4 precipitate is centrifuged off. This precipitate carries most of the fission products, and especially those with a chemistry similar to Pu(IV).
4. The supernatant solution containing Pu(VI) is made 1 M in HNO_3 , 0.05 M in N_2H_4 and 0.005 M in Fe^{++} . In this solution Pu is rapidly reduced to Pu(III).
5. The solution is diluted to 0.1 M in HNO_3 and made 0.1 M in phosphate. Bi^{+++} is then added (1 drop 0.1 M Bi^{+++} for each ml solution) to precipitate BiPO_4 , which carries all the Pu. The precipitate, which is usually contaminated with some U is centrifuged off and washed.
6. The phosphates in the precipitate are converted into hydroxides by treating with warm ~ 10 M KOH. After centrifuging the solution is drawn off, and the precipitate is washed and dissolved in hot conc. HNO_3 .
7. After some hours at room temperature, the solution is diluted to 1 M HNO_3 , and extracted with an equal volume of 0.3 M thenoyltrifluoroacetone in benzene. This gives a pure Pu(IV) solution in the benzene phase, leaving the rest of the U and the fission products in the aqueous phase.
8. If desired, the Pu(IV) can be back-extracted in to the aqueous phase with 10 M HNO_3 or HClO_4 after a two-fold dilution of the organic phase with benzene.

Procedure 10. Purification of Plutonium from Uranium and Fission Products

J. Rydberg (Ref. 341)

Outline of Method

The method takes advantage of the fact that Zr and Nb are adsorbed very well on silica gel from strong nitric acid solutions. Further decontamination from fission products is achieved by precipitation of CuS from a 0.5 M HNO₃ solution. Pu(IV) does not carry. Finally the Pu(IV) is extracted into TTA. Yield is greater than 90%. Purification is approximately 10⁶ from β-γ radiation of fission products.

Procedure

1. The UO₃ sample is dissolved in hot conc. HNO₃ and kept at 90°C for 30 min, giving a solution of U(VI) and Pu(IV).
2. The acidity of the cooled solution is adjusted to 6 M in HNO₃, and the solution is run through two columns of SiO₂ gel. This removes most of the Zr and Nb. The columns have a diameter of 0.8 cm and a length of 10 cm.
3. Cu⁺⁺, La⁺⁺⁺ and ZrO⁺⁺ (1 drop 0.1 M carrier for each ml of solution) are added to the solution, and it is then diluted to 0.5 M in HNO₃. On the addition of H₂S, CuS precipitates and carries most of the fission products with sulfides insoluble in 0.5 M HNO₃. The precipitate is centrifuged off.
4. The solution is evaporated almost to dryness and then kept for 30 min in hot ~ 10 M HNO₃. This removes H₂S and restores the Pu(IV) valency state.
5. The solution is diluted to 1 M in HNO₃ and extracted with an equal volume of 0.3 M thenoyltrifluoroacetone in benzene. Under these conditions practically only Pu(IV) and Zr(IV) are extracted, leaving U, Th(UX₁) and the rest of the fission products in the aqueous phase.
6. After a two-fold dilution of the organic phase with benzene, Pu(IV) can be extracted back into an aqueous phase with 10 M HNO₃ or HClO₄. This provides an additional purification from Zr. In practice it has not proved necessary to use this step.

Procedure 11. Uranium and Plutonium from Environmental Samples of Soil, Vegetation and Water E. L. Geiger (Ref. 144)

Outline of Method

The samples are pre-treated to bring the Pu into solution as Pu(IV) in $\text{Al}(\text{NO}_3)_3 - \text{HNO}_3$. The U and Pu is then extracted together into 50% TBP in tetradecane, washed with 4 N HNO_3 , and back-extracted into water for mounting and counting as total U and Pu. Yield is approximately 80 ± 15 (S. D. of mean)%.

Procedure

Preparation of samples

Vegetation. Cut oven-dried vegetation into small pieces and weigh 10.0 g into a 150-ml beaker. Heat the sample at 600°C, starting with a cold muffle furnace. When only white ash remains, remove the beaker from the muffle furnace and allow to cool. Carefully add 2 ml of water, then add 10 ml of 8 N HNO_3 -0.5 M $\text{Al}(\text{NO}_3)_3$ solution. Cover the beaker with a watch glass and boil the solution for 5 min. Allow to cool, add 1 ml of 2 M KNO_2 solution and transfer the sample to a 100-ml centrifuge tube. Use 4 N HNO_3 to complete the transfer. Centrifuge and decant the supernate into a 125-ml cylindrical separatory funnel graduated at 30 ml. Wash the residue with 4 N HNO_3 , centrifuge, and decant the wash solution to the separatory funnel. The acid normality of the combined solutions at this point is 4-6 N and the total volume should not exceed 29 ml. Proceed to the extraction procedure.

Soil. Grind 5 g of oven-dried soil with a mortar and pestle until the entire sample can pass through a 200-mesh sieve. Weigh 1.0 g of the 200-mesh soil into a 50-ml Pt crucible and heat the sample at 600°C for 4 hr. Remove the sample from the muffle furnace and allow to cool. Add 3 ml of 70% HNO_3 and 10 ml of 48% HF, then stir the sample for 2-3 min with a Pt rod. Heat the sample in a 200°C sand bath until all traces of moisture are removed. Repeat this HNO_3 -HF treatment, being careful that the sample is completely dry before proceeding to the next step. Allow the sample to cool and then add 15 ml of 6 N HNO_3 -0.25 M $\text{Al}(\text{NO}_3)_3$ solution. Cover with a watch glass and heat in the sand bath for 5 min. Allow to cool and decant the solution through a filter, such as Whatman No. 40, into a 125-ml cylindrical separatory funnel graduated at 30 ml. Leave as much of the residue as possible in the crucible and repeat the hot 6 N HNO_3 -0.25 M $\text{Al}(\text{NO}_3)_3$ treatment. Allow to cool and then filter. Proceed to the extraction procedure.

Water. Place 1 liter of the sample in a 1.5-liter beaker and if basic, neutralize with nitric acid. Add 15 ml of 70% HNO_3 and evaporate to 30-40 ml. Decant the solution through a filter, such as Whatman No. 40, into a 100-ml beaker. Wash the 1.5-liter beaker, the residue and the filter with 4 N HNO_3 . Evaporate the combined solution in the 100-ml beaker to 5 ml. Add 20 ml of 4 N HNO_3 , cover with a watch glass, and heat for 5 min. Transfer the sample to a 125-ml cylindrical separatory funnel graduated at 30 ml. Wash the beaker with 4 N HNO_3 and transfer to the separatory funnel, being careful that the total volume in the separatory funnel does not exceed 29 ml. Proceed to the extraction procedure.

Extraction.

Add 1 ml of 2 M KNO_2 to the sample in the 125-ml cylindrical separatory funnel. Dilute to the 30-ml mark with 4 N HNO_3 and stir the solution briefly. Add 30 ml of 50% TBP in n-tetradecane. Agitate the solution vigorously for 4 min with an air-driven stirrer. Discard the acid portion (lower layer). Wash the TBP portion with 4 N HNO_3 and again discard the acid portion. Back extract with seven 15-ml portions of distilled water, collecting the strip solution in a 150-ml beaker. Evaporate the combined aqueous portions to 10-15 ml, then quantitatively transfer the solution to a flamed stainless steel planchet. Allow to dry under a heat lamp, flame the planchet to burn off organic residue, and count on an α -counter. Retain for pulse-height analysis if the α -count exceeds a specified level.

Procedure 12. Plutonium from Environmental Water Samples J. Scheidhauer,
L. Messanguiral, and A. M. Meiraneisio (Ref. 352)

Outline of Method

Pu(IV) is separated by chemisorption on solid CaF_2 as the concentration step, and further purified with two TTA extraction cycles. The chemisorption step has been shown to be quantitative and very efficient. The sensitivity can be made very great, as low as $0.7 \times 10^{-11} \mu \text{ Ci/ml}$ by taking a large sample.

Reagents

Concentrated nitric acid (d = 1.38)
10 N nitric acid
2 N nitric acid
1 N nitric acid
Concentrated hydrofluoric acid
Concentrated perchloric acid
Ferric nitrate
Hydroxylamine hydrochloride
1 M hydroxylamine hydrochloride
Sodium nitrite
Ammonium thiocyanate
2 M $\text{Al}(\text{NO}_3)_3$ - 0.5 N HNO_3
Calcium fluoride
Solution of 111 g/l TTA in xylene

Procedure

1. Place 3 liters of filtered water to be analyzed in a beaker and add 5 g each of ferric nitrate and hydroxylamine hydrochloride.
2. Heat and agitate with a glass stirring rod to about 60-70°C.
3. Let the solution cool down, making sure the Fe^{+++} is reduced by spot testing with several crystals of ammonium thiocyanate from time to time.
4. Pour this solution in a plexiglass column which is closed at one end and add water to within 0.5 cm of the top. Start agitation with a magnetic stirrer.
5. Add 10 g sodium nitrite. After several minutes add 60 ml concentrated HNO_3 (d = 1.38), then 45 ml concentrated HF when the HNO_3 has redissolved the ferric hydroxide which has formed.
6. Then add 0.2 g calcium fluoride powder and place the filtration system on the column (see Fig. 58).
7. After agitating for 1 hr, invert the column over a 5-10 liter plastic receiving vessel. The filtration may be speeded by maintaining pressure by means of a laboratory pump.
8. Wash the filter cake two times with 250 ml of distilled water introduced into the tube under pressure.

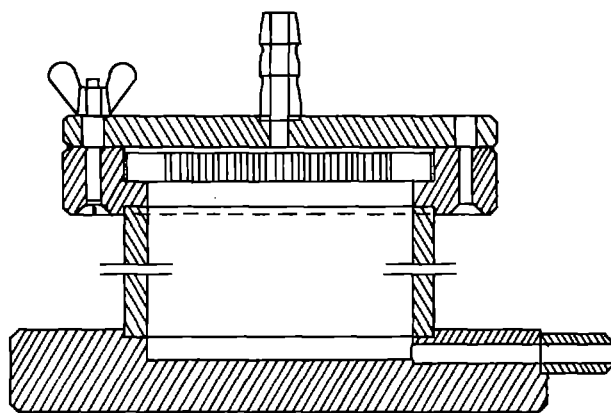

Fig. 58. Cross sectional view of the agitation column. The material is "Altuglas MZD" throughout except for the brass screws. The diffuser plate has a total of 213 holes drilled on 8 concentric circles. The inside dimensions of the column are 8.0 cm diameter by 60 cm high. The reader is referred to the original paper for a more detailed drawing.

9. After disassembly of the filtration apparatus the filter membrane is placed in a 100-ml beaker. The apparatus is washed briefly with distilled water which is poured into the beaker.
10. Add 4 ml of the $\text{Al}(\text{NO}_3)_3 - \text{HNO}_3$ solution and bring to a boil. When the volume is reduced to approximately 20 ml, remove the filter and wash it with water. Continue to evaporate to about 15 ml.
11. Add 4 ml 1 M hydroxylamine hydrochloride and let cool. Make sure the Fe^{+++} is completely reduced by spot testing (with ammonium thiocyanate).
12. Add 0.5 sodium nitrite and start agitation. Add 1.5 ml 10 N HNO_3 and make sure by spot testing that the ferrous ion is oxidized. Expel the nitrous vapors.
13. Add 15 ml TTA-xylene solution. Agitate so that the two phases are well mixed for 1/2 hr.
14. Permit the phases to separate and draw off the aqueous phase with a pipette. Wash two times with 5 ml 1 N HNO_3 .
15. Back-extract the Pu(IV) by agitation with 5 ml 10 N HNO_3 for 1/2 hr. Wash the organic phase two times with 3 ml 10 N HNO_3 .
16. The 10 N HNO_3 phases are combined in a 30-ml beaker and evaporated to dryness.
17. Take up with 2 ml fuming HNO_3 and 3 ml HClO_4 and evaporate to dryness.
18. Stop heating and add 1 ml 1 M hydroxylamine hydrochloride when the temperature permits.
19. Let the solution cool and verify that Fe^{+++} is reduced by spot testing using a very thin glass rod.
20. Add 1 ml 1 N HNO_3 and transfer to a 30-ml separatory funnel, washing the beaker two times with 1 ml of 1 N HNO_3 .
21. Add 0.15 g NaNO_2 to the funnel. Wash the beaker again with 1 ml 2 N HNO_3 and 0.5 ml 2 N HNO_3 . Combine these washes in the funnel.
22. Stir slowly for 5 min to expel the nitrous vapors.
23. Add 5 ml TTA-xylene and stir for 20 min at maximum speed.
24. Let the phases separate and eliminate the aqueous phase. Wash two times by agitation for 10 min with 3 ml of 1 N HNO_3 .
25. The Pu is next re-extracted by agitation for 20 min with 5 ml of 10 N HNO_3 , and the organic phase is washed two times with 2 ml of 10 N HNO_3 .
26. The combined aqueous phase is evaporated on a watch glass and counted.

Procedure 13. Plutonium from Environmental Water Samples J. Kooi and U. Hollstein (Ref. 237).

Outline of Method

BiPO_4 is used to concentrate the Pu after reduction to Pu(IV) with SO_2 gas. The solution is heated to 100°C for several minutes to expel excess SO_2 . The Pu is further purified by co-extraction into ferric cupferride as Pu(III) from dilute nitric acid. Finally, the organic matter is destroyed by wet-ashing with H_2SO_4 and HNO_3 and the Fe^{+++} precipitated as the hydroxide, mounted and counted.

Yield. Approximately 99% from solutions containing $0.8 \times 10^{-6} \mu \text{ CiPu/ml}$.

Procedure

1. Acidify a 500 ml sample of water with 15 ml of 2 N nitric acid and add 10.4 mg of Bi^{3+} .
2. Bubble SO_2 gas, technical, gently through the solution for 20 min, using a wide capillary.
3. Heat the solution to boiling and keep it boiling at 100°C for some minutes to expel the excess of the SO_2 . Add slowly 60 ml of a 1 M solution of orthophosphoric acid under continuous stirring with a glass rod and leave the suspension at 90°C for 30 min with occasional stirring. Allow the precipitate to settle for at least 2 hr, by preference overnight.
4. Filter through a fine-fritted funnel, the stem of which has been drawn into a wide capillary. Use 25 ml of 8 N HCL in total to rinse the beaker and the glass rod and to dissolve the precipitate on the funnel. Suck the solution through the funnel directly into a 50-ml narrow-necked flask placed in a filtering flask with cut-off bottom, resting on a ground-glass plate.
5. Transfer the Bi-Pu solution to a 250-ml beaker, rinse the flask with a little distilled water and add 5 ml of freshly prepared 10% hydroxylamine hydrochloride solution. After 15 min make up to about 100 ml with distilled water.
6. Using a pH meter, adjust the pH to 0.7-0.8 by addition of 70-90 ml of 2 N ammonia. Add 0.1 mg of Fe^{+++} .
7. Transfer the solution into a 1-1 separatory funnel, lubricating the stopcock with any kind of grease that can be completely removed by the oxidation as described in 14-16. Add 2 ml of a freshly prepared 5% cupferron solution in water, shake, and let stand for 45 min.
8. Add 30 ml of purified chloroform. Shake the mixture repeatedly for 1 min and run the chloroform extract through a 4-5 cm No. 41 Whatman filter paper into a 250-ml separatory funnel, using the same kind of grease for the stopcock.
9. Shake the chloroform solution with 20 ml of 0.3 N hydrochloric acid containing 1.5 g of cupferron per liter, and run the chloroform layer through a No. 41 Whatman filter paper into a 250-ml roundbottom flask with ground joint. Transfer the water layer of the lower separatory funnel into the upper one.

10. Add to the solution in the upper funnel 0.1 mg Fe^{+++} and 2 ml of a 5% cupferron solution, shake, and let stand for 45 min.
11. Repeat the whole extraction procedure twice (8 and 9) with 25 ml of purified chloroform. Transfer the water-layer resulting from the first repetition from the lower to the upper funnel. Discard both water-layers in upper and lower funnel after the second repetition.
12. Wash down the sides of the two filter papers into the roundbottom flask with as little chloroform as possible to remove traces of red-brown iron-cupferrate.
13. Distill off the chloroform until about 20 ml is left and remove the remainder of chloroform by gentle blowing or suction, as shown in Fig. 59.
14. Add 1 ml of concentrated sulfuric acid (C. P. grade) and attach to the round-bottom flask a 15-cm condenser. Reflux for 30 min.
15. Add 2 ml of fuming nitric acid (C. P. grade) and heat until the solution appears light yellow.
16. Remove nitrous vapors and sulfur trioxide first by heating, later by sucking air through an attachable tube, creating slight turbulence in the bulb and the neck of the roundbottom flask. Two burners should be used, one to keep the bulb hot, without heating the dry residue to a red glow, however; and the other to prevent condensation in the neck of the round-bottom. If the dry residue does not appear snow-white after cooling, repeat 14 and remove sulfur trioxide by heating as above.
17. Dissolve the white residue in 1 ml of concentrated HCL while gently heating. Some time may be needed before the solid is completely dissolved.
18. The final sample for counting is deposited on a Pt tray of 35 mm diameter and 1/8 cm thick. Determine the counter background with the tray in counting position. Place the tray under a radiant heater and, using a drawn-off pipette, transfer the green-yellow solution onto the tray, covering about half of the area. Rinse the flask with a second ml of concentrated HCL and transfer the washing onto the tray. Repeat with 1 ml of water. After evaporation to near dryness, add a few drops of water.
19. Enclose the tray and two 10-ml beakers filled with 10-15% ammonia in a large beaker upside down. Let stand for at least 5 min to ensure the formation of $\text{Fe}(\text{OH})_3$ to be completed. Evaporate to dryness.
20. Place the tray in a porcelain dish, cover it with a second dish, and ignite for 10-15 min to convert the hydroxides to oxides.
21. Count the sample under an α -counter. A simple counting device consisting of a photomultiplier and a ZnS screen, provided with a light trap for inserting samples without switching off the high voltage, showed to be very reliable and satisfactory. Efficiencies up to 47-50 percent may easily be obtained. Calculate the Pu concentration according to the formula

$$C_{\text{Pu}} = 9.01 \times 10^{-8} \frac{A}{E} \mu\text{c/ml}$$

where A = activity of sample in counts per minute and E = percentage efficiency of counter.

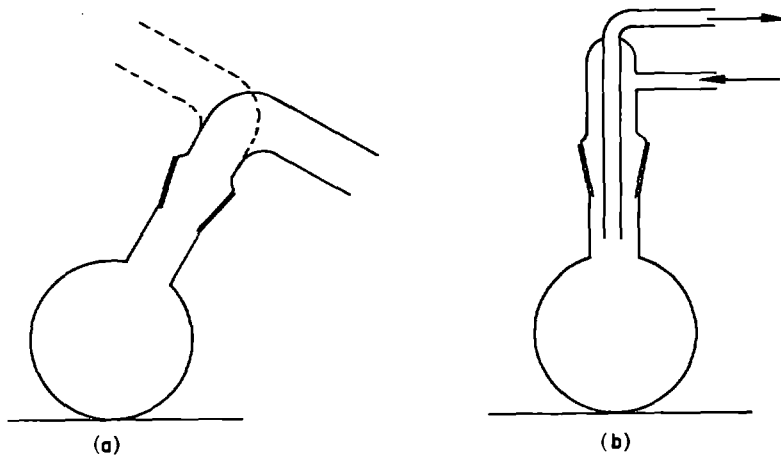

Fig. 59. Roundbottom flask used for destruction of organic matter. (a) Set-up used for refluxing (----) and removal (—) of nitric acid. (b) Set-up used for removing chloroform and sulfur-trioxide vapors.

Procedure 14. Separation of Plutonium in Uranium-Plutonium Fission Element Alloys by TBP Extraction from Chloride Solutions R. P. Larsen and C. A. Seils, Jr. (Ref. 249)

Outline of Method

The U and Pu are reduced to U(IV) and Pu(III) by contact with Mg turnings in a 2 M HCl solution. The U is then extracted into TBP. The Pu is then oxidized to Pu(IV) with NaNO₃ and extracted into TBP and back-extracted with 0.1 M HCl. The Pu is then precipitated as the hydroxide and taken up in HNO₃ for spectrophotometric determination.

Reagents

Unless otherwise stated, reagent grade materials are used.

1. Tributyl phosphate, 30-volume % in carbon tetrachloride.
2. Tributyl phosphate, 30 volume % in Amsco-140 (a kerosine distillate).
3. Dilute 300 ml of tributyl phosphate (Commercial Solvents Corp.) to 1 liter with carbon tetrachloride (or Amsco-140). Scrub once with 200 ml of 0.5 N sodium hydroxide to remove traces of mono- and dibutyl phosphate. Scrub four times with distilled water and filter through a large dry filter paper to remove cloudiness.

Procedure

Dissolve the alloy sample, using the procedure described by Larsen* for this type of material, and dilute to volume.

Pipette an aliquot containing 10 to 20 mg of Pu into a 50-ml Erlenmeyer flask. For 20% Pu alloys, there will be 35 to 70 mg of U, more than enough for its determination. Convert to a chloride medium by evaporation to near dryness (3X) with 12M hydrochloric acid. Adjust the volume to 10 ml and the hydrochloric acid concentration to about 2M. Add approximately 0.1 g of Mg turnings over a period of several minutes. Using a double layer of glass fiber filter paper in a filter chimney assembly, separate the precipitated Group VIII elements by filtration, and catch the filtrate in a 60-ml cylindrical separatory funnel. Rinse the flask and filtering assembly with three 5-ml portions of 12M hydrochloric acid. Add 15 ml of 30% tributyl phosphate in carbon tetrachloride and shake for 1 min. Allow the phases to separate and transfer the U-bearing organic phase to a second 60-ml separatory funnel.

Repeat the extraction with 10 ml of 30% tributyl phosphate in carbon tetrachloride and combine the U-bearing organic phases in the second separatory funnel. Treat the Pu-bearing aqueous phase by the procedure outlined in the next paragraph. Add 15 ml of 0.5M hydrochloric acid to the combined organic extracts and shake for 1 min. Allow the phases to separate and drain the stripped organic phase into a 60-ml separatory funnel. Add 10 ml of 0.2M hydrochloric acid and repeat the stripping operation. Discard the organic phase and combine the aqueous strip solutions in the second separatory funnel. Add 5 ml of carbon tetrachloride and shake 30 sec to wash out dissolved tributyl phosphate from the aqueous phase. Discard the organic layer. Rinse the U solution into

* Larsen, R. P., Anal. Chem. **31**, 545 (1959).

a 50-ml Erlenmeyer flask and evaporate to dryness (2X) on a sand bath after addition of 2-ml portions of 16M nitric acid. Add 5.0 ml of 16M nitric acid to dissolve the U. Transfer to a 50-ml volumetric flask with water and make up to volume. Determine U x-ray spectrometrically. For samples containing less U, use proportionately smaller volumes of nitric acid and volumetric flasks (down to 5 ml).

Add approximately 100 mg of sodium nitrite to the aqueous raffinate from the U separation to oxidize the Pu to the quadrivalent state. Add 20 ml of tributyl phosphate-Amsco-140 and equilibrate 1 min. (Amsco-140 is used as the inert diluent to give a light organic phase.) Discard the lower aqueous raffinate. Add 15 ml of 0.2M hydrochloric acid and equilibrate 1 min. Allow the phases to separate and transfer the aqueous phase to a 50-ml Erlenmeyer flask. Add 10 ml of 0.2M HCL to the organic phase and repeat the stripping operation. Combine the aqueous strip solutions, add 2 ml of 12M hydrochloric acid, and evaporate on a sand bath to reduce the volume to approximately 2 ml. Transfer the solution to a 15-ml glass centrifuge cone with a transfer pipette and dilute to 7 ml with water. Add 0.5 ml of 20% hydroxylamine hydrochloride and let stand 15 min with occasional mixing. While mixing with a Pt stirring wire, add 10M sodium hydroxide dropwise until plutonium hydroxide precipitates. Add 10 drops of sodium hydroxide solution in excess and let stand for 5 min. (Evaporation is not a satisfactory volume-reduction step, as it does not remove chloride. With the nitrate introduced in the next step, oxidation of the Pu to the sexivalent state would occur.) Centrifuge for 5 min and discard the clear supernate. Wash the precipitate with water, centrifuge for 3 min, and discard the wash solution. Add 2.0 ml of 16M nitric acid and stir to dissolve the precipitate. Heat the nitric acid solution in a boiling water bath for 20 min. (This treatment will destroy any polymeric Pu which may be present and ensure complete oxidation of the Pu to the quadrivalent state. If the precipitate were dissolved in hot 3M nitric acid, some oxidation to the sexivalent state would occur.) Allow the solution to cool and dilute to volume in a 10-ml volumetric flask with water. Read the absorbance vs a reagent blank in 1-cm cells at 475 m μ and a slit width of 0.02 mm. Calculate the Pu present from a calibration factor prepared from a series of standards carried through the hydroxide precipitation step only.

Procedure 15. Separation of Pu before Spectrographic Analysis of Impurities Anion Exchange Method F. Trowell (Ref. 405)

Outline of Method

Pu metal is dissolved in HCl and an excess of 8 M HNO₃ is added. Pu is adsorbed on an anion exchange column from the resulting mixture and the column is washed with 8 M HNO₃. The solution and wash is evaporated to dryness, taken up in 6 M HCl, and spectrographically analyzed for Al, Be, Ca, Cd, Co, Cr, Cu, Fe, Mg, Mn, Mo, Ni, Ti, and U.

Reagents

1. 8 M HNO₃ (Note a).
2. 6 M HCl (Note b).
3. Resin (Note c).

Procedure

1. Weigh duplicate portions of 0.25 g of Pu metal and dissolve each by tipping into 1 ml 6 M HCl in 50-ml silica beakers.
2. When all traces of metal have dissolved, add 5 ml 8 M HNO₃ and mix well. Note (d).
3. Transfer the resulting green solutions to the ion exchange columns (Note (e)) using the minimum volume of 8 M HNO₃ to rinse out the beakers.
4. Place 50 ml silica beakers containing 1 ml of 100 µg/ml Sc solution under the columns to collect the eluted solutions. Allow the Pu solutions to drain down to the top of the resin.
5. Add 15 ml 8 M HNO₃ to the columns and allow this eluting acid to drain through.
6. Transfer the silica beakers to the fume cupboard and evaporate the solutions to dryness. Note (f).
7. Add 1 ml 6 M HCl to the dry residues and warm slightly to ensure complete solution; draw into polythene ampules. Note (g)
8. Prepare duplicate reagent blanks using the procedure and reagents above but omitting the Pu.
9. Pass 0.3 M HNO₃ through the columns until all traces of green color have been removed (Note (h)). Recondition the column for further use with 8 M HNO₃. Note (i).

Notes

- (a) Prepared from concentrated HNO₃ (redistilled from silica) and deionised water.
- (b) Prepared from gaseous HCl and deionised water.
- (c) Deacidite FF (SRA 68). Remove fines by stirring with water. Allow to settle for 10 min and decant off any resin still in suspension; repeat this

procedure until all fines are removed. Use 3 ml wet resin in a 6-mm bore silica column fitted with a quartz wool plug. (See Fig. 60). for dimensions.)

- (d) At this stage the color changes from blue to green.
- (e) Condition the columns immediately before use by allowing 10 ml 8 M HNO_3 to run through them.
- (f) This solution contains the impurities free from Pu.
- (g) This solution is ready for analysis by the polythene funnel method.
- (h) Collect the washings and transfer to the appropriate residue bottle.
- (i) Add about 10 ml 8 M HNO_3 and stir the resin with a pointed 1/8-in. perspex rod until it is in suspension and all air bubbles have been removed. Allow to settle for 10 min and decant off any resin still in suspension. Add fresh resin to bring the total resin volume to 3 ml.

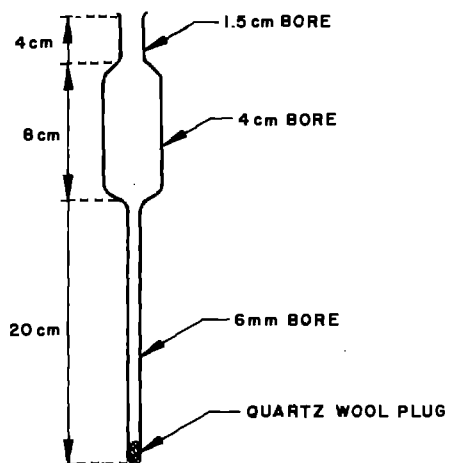

Fig. 60. Ion exchange column.

Procedure 16. Separation of Plutonium Before Spectrographic Analysis of Impurities. Extraction Chromatography Method Using TBP F. Trowell (Ref. 405)

Outline of Method

Pu in 8 M HNO₃ solution is adsorbed on a KelF/TBP chromatographic column and the impurities eluted with 8 M HNO₃. Sc is added as an internal standard to the eluted solution which is then concentrated by evaporation and analyzed by the graphite spark technique for Al, Co, Cr, Fe, Ga, Mn, Ni, and Ti.

Applicability. This method is intended for the analysis of high-purity Pu. The concentration range covered is from 0.5 to 10 ppm. The lower limit of analysis may be restricted by the reagent blank.

Equipment

1. Column (for dimensions and preparation see Appendix).

Reagents

1. 6 M HCl. Note (a).
2. 16 M HNO₃. Note (b).
8 M HNO₃.
0.32 M HNO₃.
3. 2 M HF. Note (c).
4. CCl₄. Note (d).
5. Tri-n-butyl phosphate. Note (e).
6. KelF. Note (f).
7. Grease solution. Note (g).

Procedure

1. Weigh 2 g of Pu and dissolve by tipping into 5 ml 6 M HCl in a 50-ml silica beaker. Cover with a clock glass and warm. Note (h).
2. When all traces of the metal have dissolved, rinse and remove the clock glass, rinse down the sides of the beaker, and evaporate the solution to dryness.
3. Cool (Note (i)), add 5 ml 16 M HNO₃, warm and add 5 drops 2 M HF to ensure complete solution. Evaporate to a moist residue. Note (j).
4. Redissolve this residue in 10 ml 8 M HNO₃, warming to ensure complete solution.
5. Transfer the solution to the KelF/TBP column using the minimum volume of 8 M HNO₃ to rinse out the beaker. Note (k).
6. Place a 50-ml tall-form silica beaker containing 1 ml 20 µg/ml Sc solution under the column. Note (l).

7. Allow the solution from (5) to drain down to the top of the chromatographic column maintaining a flow rate of approximately 0.5 ml/min. Add 40 ml 8 M HNO₃ and allow to drain through the column at the same rate.
8. Transfer the eluted solution to a 100-ml separating funnel and wash with 10 ml conditioned CCl₄, repeat the wash with two further portions of 10-ml CCl₄.
9. Transfer the washed solution to the 50-ml beaker and evaporate to dryness in a fume cupboard. Note (m).
10. Redissolve the residue in 1 ml 6 M HCl while the beaker is still warm.
11. Duplicate reagent blanks are prepared using the procedure and reagents above, but omitting the Pu.
12. Prepare the electrodes for sparking by pipetting 0.1 ml of the solution from (10) on to the tops of a pair of waterproofed graphite electrodes, dividing the aliquot equally between the two electrodes, and dry under an infrared lamp. Prepare duplicate pairs of electrodes for each standard sample and reagent blank solution. Note (n).
13. Remove the adsorbed Pu from the column by eluting with 0.32 M HNO₃ (Note (o)) and then wash the column with water to remove the HNO₃. Note (p).

Notes

- (a) Prepared from gaseous HCl and deionized water.
- (b) HNO₃ AR redistilled from silica apparatus. Diluted with deionized water.
- (c) Prepared from HF AR and deionized water.
- (d) CCl₄ AR conditioned before use by shaking with an equal volume of 8 M HNO₃.
- (e) Commercial TBP purified by steam distillation and alkaline washing (see Appendix).
- (f) Low density KelF moulding powder, less than 100 mesh (see Appendix).
- (g) 0.1% Apiezon M in CCl₄.
- (h) Each sample should be done in duplicate.
- (i) A vigorous reaction occurs if addition of concentrated HNO₃ is made to hot residue.
- (j) If the residue is allowed to go to dryness it will be difficult to redissolve.
- (k) See Appendix for column preparation.
- (l) Vitrosil tall-form beaker nominally 50 ml capacity in fact has a volume of about 75 ml.

- (m) The activity of the solution is due almost entirely to the Am content of the Pu metal. In general this is sufficiently low to allow a number of solution to be evaporated to dryness at one time without exceeding the tolerance limit allowed in a fume cupboard.
- (n) Each sample and reagent blank will thus have four exposures.
- (o) Transfer the solution to the appropriate residue bottle.
- (p) The column life is limited as some TBP is washed off with each run. The effect of this is that the adsorbed Pu layer becomes longer with each run and the column must be replaced when the danger of Pu break-through becomes apparent.

Appendix

Purification of TBP

1. Place 250 ml commercial TBP and 100 ml 0.5 M NaOH in a 1-litre flask fitted with a splash head for steam distillation. Heat the mixture to 80°C, but take care not to heat above this temperature. Note (a).
2. Remove the source of heat and steam distil for 3 hr, rejecting the distillate. Note (b).
3. Pour the hot TBP/NaOH mixture into a separating funnel and reject the (lower) aqueous phase. Wash the TBP with two 100-ml portions of hot deionized water and then with two 100-ml portions of cold deionized water. Note (c).
4. Filter (Whatman 541 paper) the washed TBP into a clean dry reagent bottle.

Preparation of KelF Powder

1. Chill KelF low density molding powder with solid CO₂ and grind in a microhammer mill. Note (d).
2. Sieve the milled powder and collect the material passing 100 mesh (BSS). Note (e).
3. Wet the powder with acetone, transfer to a 1-liter beaker and add excess of 6 M HCl (Note (f)). Allow the KelF/HCl suspension to stand overnight.
4. Pour the KelF/HCl suspension into a funnel fitted with a cotton wool plug and allow the acid to drain away. Wash the KelF free from acid by pouring deionized water through the funnel.
5. Finally, dry the washed KelF by pouring acetone through the funnel and then spreading the powder out onto a polythene sheet and allowing the acetone to evaporate.

Preparation of Column

1. Mix 12 g KelF powder and 12 g TBP to a smooth paste, add about 10 ml deionized water and mix to a slurry.

2. Transfer about a quarter of this slurry to the column (Note (g)) filled with water and gently press small quantities of this slurry down with a glass plunger so that an evenly packed column of the KelF/TBP is formed. Note (h).
3. Repeat this procedure with further portions of the slurry until the column is complete.
4. Keep the column filled with water until required for use and condition with 40 ml 8 M HNO₃ when required.

Notes

- (a) TBP/NaOH mixtures bump violently.
- (b) This removes most of the free n-butyl alcohol from the TBP; the remainder is removed by washing.
- (c) The initial separation and washings must be done hot to avoid emulsification.
- (d) Chilling assists the grinding process.
- (e) Making the powder just moist with acetone will prevent it sticking to the sieve.
- (f) To remove any metallic impurities.
- (g) 28 cm × 1.2 cm Pyrex column, 2-mm bore tap and fitted with a quartz wool plug.
- (h) Care must be taken in the preparation of the column, loose packing may result in Pu breakthrough during elution; tight packing will give a very slow flow rate.

Procedure 17. Separation of Np and Pu by Anion Exchange N. Jackson and J. F. Short (Ref. 204)

Outline of Method

This procedure is described for macro amounts of Pu and Np. It is based on the fact that Pu(III) is not adsorbed on anion exchange resin, while Np(IV) is strongly adsorbed at high HCl concentrations. The valence adjustment is done before adsorption on the column by dissolving the hydroxides in a concentrated HCl solution which has been saturated with NH_4I . The Np is removed from the column with 2 M HCl. The separation is quantitative and complete.

Procedure

The purification of 2.3 g of Np^{237} from approximately 50 mg of Pu^{239} was then undertaken. The Np and Pu were precipitated as hydroxides, centrifuged, and dissolved in 210 ml of conc. HCl sat. with NH_4I . The solution was allowed to stand for 30 min and poured onto a Deacidite FF anion column 20 cm long and 2.5 cm diameter while a flow rate of 1 ml/min was maintained. The first 200 ml of effluent were pale blue [Pu(III)]. The column was then washed with 100 ml conc. HCl and the wash collected separately. No activity was found in a drop collected at the end of the washing.

The Np was finally eluted with 2M HCl. It was possible to follow the dark green band of the Np down the column and the first 40 ml of eluate was included with the conc. HCl wash. The whole of the Np was collected in the next 50 ml of eluate. No activity was found in any eluate after this stage. Some β - γ activity was detected on the glass wool at the top of the resin column and was assumed to be Pa^{233} , the daughter of Np^{237} .

Procedure 18. Separation of Np and Pu by Cation Exchange Chromatography V. D. Zagrai and L. I. Sel'chenkov (Ref. 435).

Outline of Method

Np(IV) and Pu(III) are adsorbed on the cation resin KU1 or KU2 from 0.25 M HCl solution after reduction with SO₂ at boiling water temperatures. Np is eluted with 0.02 N HF and the Pu stripped with 0.5 N HF.

Procedure

1. To 6-8 ml of 0.25 N HCl containing μg amounts of Np and Pu, add about half of the resin in the hydrogen form required to fill the plexi-glass column (1 mm diameter \times 90 mm high) and 1-2 ml of water.
2. Pass SO₂ gas through the solution vigorously for 15-20 min while heating on a boiling water bath.
3. Allow the solution to cool to room temperature and transfer the resin to the column with a pipette. Plug the top of the column with cotton and pass the remaining solution through the column.
4. Wash the resin with 10 ml of 0.25 N HCl, followed by 10 ml of H₂O.
5. Elute the Np into a Pt dish or a Teflon beaker with 40-60 ml of 0.02 N HF.
6. Elute the Pu with 4-5 ml of 0.5 N HF.

Procedure 19. Determination of Plutonium in Urine R. O. R. Brooks (Ref. 56)

Outline of Method

A 24-hr sample of urine is dried and ashed and the residue dissolved in dil. HCl and adjusted to a pH of 1. The Pu is reduced to the trivalent state with hydroxylamine hydrochloride solution and co-precipitated on iron cupferride. This is extracted with chloroform, the chloroform is distilled off, and the cupferrides residue is wet oxidized. The iron carrying the Pu is finally mounted with conc. HCl, dried, precipitated with ammonium hydroxide, dried again, and flamed off to Fe_2O_3 . This procedure is based on that described by Smales *et al.*²³³ Differences in the two procedures are given at the end of this procedure.

Reagents

Ferric chloride solution. 145 mg of FeCl_3 /liter (i. e. 50 mg Fe/liter).

Hydroxylamine hydrochloride solution. 50 g of $\text{NH}_2\text{OH}\cdot\text{HCl}$ /liter.

Cupferron. 5% aqueous solution, renewed weekly.

Procedure

1. Evaporate a 24-hr sample of urine overnight in a 2-liter porcelain basin under infrared lamps.
2. When dry, scrape out and quantitatively transfer the residue to a 200-ml silica dish with washings of 4 N HCl, and re-dry it under infrared lamps.
3. Place the sample in a muffle furnace at 500°C, and hasten oxidation by periodic additions of 3-ml lots of conc. HNO_3 to the dish when it is cool.
4. Dissolve the white residue in ~30 ml of 4 N HCl, transfer to a 250-ml beaker and make up with alternate 4 N HCl and water washings to about 100 ml to a final acidity of 2 N. Stir until only an insoluble silica residue remains. Add 5 ml of FeCl_3 solution and 10 ml of $\text{NH}_2\text{OH}\cdot\text{HCl}$ solution followed by a few drops of cresol-red indicator.
5. Adjust the pH of the solution to 1 (with a pH meter until the operator can correctly do it visually) with 2 N NH_4OH added dropwise from a burette with constant stirring. It is essential that no phosphate precipitate forms, as this may reduce recoveries. Allow the solution to stand for 1 hr to ensure reduction of Pu(VI) to Pu(III).
6. Transfer the solution to a 500-ml separating funnel and add 2 ml of 5% cupferron solution. Shake the contents thoroughly and let stand for 3/4 hr to allow complete formation of iron cupferride.
7. Add 30 ml of chloroform and shake the funnel thoroughly. Allow the chloroform layer to settle and then run it off through a 7-cm Whatman No. 41 filter paper into a 100-ml separating funnel. Wash the chloroform by shaking with 20 ml of distilled water and run the

chloroform into a 250-ml round-bottomed flask through a 7 cm No. 41 filter paper as before. Return the water to the original aqueous solution and add a further 5 ml of FeCl_3 and 2 ml of 5% cupferron as a scavenge. After shaking, leave the solution to stand for another $3/4$ hr.

8. Extract the cupferrides with three 15-ml lots of chloroform – or until the chloroform remains colorless – and filter each lot separately into the 100-ml funnel. Wash the filter paper with chloroform from a pipette to remove the ring of cupferrides which forms around the top, and collect the washings in the 100-ml separating funnel.
9. Add 20 ml of distilled water to the chloroform extracts, and shake the funnel. After they have settled out, filter the extracts into the 250-ml round-bottomed flask and wash the filter paper with chloroform.
10. Evaporate off the excess chloroform in a fume cupboard using an "Electro-Thermal" mantle. Remove the final drops by blowing in air.
11. Add 3 ml of conc. H_2SO_4 and 1 ml of conc. HNO_3 to the residue and heat. Evaporate the final traces of H_2SO_4 by blowing in air. If the residue is not white, add further aliquots of the acids and take to dryness again.
12. Dissolve the residue in 3 ml of conc. HCl and transfer by means of a pipette to a Pt tray previously counted for background. Use two further 3-ml aliquots of conc. HCl to obtain a quantitative transfer.
13. Dry the final solution, then take up in a few drops of water and add enough 2 N NH_4OH to ensure complete precipitation of ferric hydroxide. Spread this precipitation evenly over the tray (15 cm^2 effective surface) using a glass rod with a fine tip.
14. Dry the tray, and finally heat it over a bunsen to form the red oxide Fe_2O_3 before counting.

Counting Procedure

Count the tray "background" and sample each for one period of 8 hr in an α -scintillation counter.

Calculating Maximum Permissible Level in Urine

Maximum permissible level in the body is $0.04 \mu\text{c}$ for Pu^{239} (solution).
Excretion rate assumed is 0.01% per day.

Corresponding Maximum Permissible Level in Urine is $\therefore 4 \mu\mu\text{c}$

With a method recovery of 90% and a counter efficiency of (say) 35%, the maximum permissible level in urine ≈ 2.8 cpm above "background."

Reporting Results

Results are reported in $\mu\mu\text{c}/24\text{-hr}$ sample in the following ranges:

- < 0.1 $\mu\mu\text{c}$
- < 1 > 0.1 $\mu\mu\text{c}$
- > 1 $\mu\mu\text{c}$ (exact figure reported with standard deviation).

NOTE:

Deviations from this report in steps 4, 7, and 8 above were made for reasons of economy. The use of smaller quantities of reagents were found not to affect the overall recovery. By using the amounts of H_2SO_4 and HNO_3 quoted in step 11 above, a more rapid oxidation was achieved.

Procedure 20. Determination of Pu²³⁹ in Urine (Small Area Electrodeposition Procedure) R. W. Perkins (Ref. 316)

Outline of Method

This procedure describes a method for the rapid separation of Pu²³⁹ from 200 ml (or smaller) urine samples, and the subsequent electrodeposition of the Pu²³⁹ on an 8-mm² area of a stainless steel disk. The yield for a set of five samples was 85.2 percent ±3.6 percent standard deviation.

Procedure

1. Place the urine sample (200 ml or less) in a 1-liter Erlenmeyer flask, add 50 ml of concentrated HNO₃, 40 mg of Pr carrier (Note (a)) and evaporate to about 20 ml. Add 20 ml of H₂O and cool under running water, then transfer the solution to a 100-ml Lusteroid test tube (using about 20-30 ml of wash water) containing 5 ml concentrated HF and stir.
2. Allow the sample to stand 30 min, centrifuge 2 min, discard the supernate and dissolve the precipitate in 50 ml of 2 N HNO₃. Add 5 ml of concentrated HF and stir. Allow the sample to stand 5 min, centrifuge 2 min, discard the supernate and dissolve the precipitate in 5 ml of H₂O and 20 ml of 2 M Al(NO₃)₃-0.5 N HNO₃.
3. Transfer the solution to a 120-ml separatory funnel and shake 5 min (or until clear). Add 0.25 ml of 2 M NaNO₂ and shake 15 min. Add 10 ml of 0.45 M TTA (100 g/liter) in benzene and shake for 20 min. Discard the aqueous phase and wash the organic phase with two 10-ml portions of 0.5 N HNO₃, 5 min each.
4. Add 10 ml of 8 N HCl and shake 15 min. Collect the aqueous layer in a 50-ml beaker. Add 5 ml of 8 N HCl to the organic phase and shake 5 min. Collect the aqueous phase.
5. Combine the aqueous layers, add 5 ml of concentrated HNO₃, 3 ml of concentrated HClO₄, 1 ml of 0.1 M KNO₃ and evaporate to dryness. (Use low heat for final evaporation.)
6. Dissolve the residue in 7 ml of 0.5 N HNO₃ (Note 2). Rub sides of beaker with policeman to make sure all of the residue is in solution. Wash policeman with water, adding washings to the sample, then evaporate the solution to 3-4 ml.
7. Add 4 ml of electrolyte (0.25 M (NH₄)₂ C₂O₄), transferring the solution to an electrodeposition cell with an 8-mm² stainless steel cathode area (Note 3).
8. Electrodeposit overnight at 110 mA.
9. The electrodeposited sample may be counted directly on a low background α counter, or exposed to a nuclear track film and the α tracks counted under a microscope* to provide a greater sensitivity.

* L. C. Schwendiman and J. W. Healy, Nucleonics 16, No. 6, 78, 80-82 (1958) June.

Notes

1. The element praseodymium as purchased (from the Lindsey Chemical Division of the American Potash and Chemical Corporation, West Chicago, Illinois) could be used directly without causing a high background; whereas, the use of lanthanum as a carrier resulted in a high background.
2. At this point, the sample can be evaporated on a counting dish for direct counting if small area deposition is not required.
3. The electrolytic cells consist of lucite cylinders which are threaded at one end for stainless steel caps which contact the stainless steel cathode plating surfaces. A beveled lucite disk fits between the cap and cylinder and defines the electrodeposition area.

Outline of Method

Micro amounts of Pu are isolated by lanthanum fluoride coprecipitation, thenoyltrifluoroacetone (TTA) extraction, and electrodeposition. The α activity is measured by proportional counting or by autoradiography.

Evaporation and Electrodeposition

Reagents and equipment.

Electrodeposition apparatus and cells.

Stainless steel disks, 0.5-in. diam \times 0.005-in. thick, polished stainless steel.

Aluminum nitrate solution – Dissolve 378 g $\text{Al}(\text{NO}_3)_3 \cdot 9\text{H}_2\text{O}$ in 800 ml distilled water; add 23 ml conc. HNO_3 and dilute to 1 liter with distilled water.

Conc. ammonium hydroxide – NH_4OH (30% NH_3).

Ammonium hydroxide, 10% solution – Dilute 10 ml conc. NH_4OH to 100 ml with distilled water.

Conc. hydrochloric acid, 36% HCl .

Conc. hydrofluoric acid, 48% HF .

Conc. nitric acid, 70% HNO_3 .

Conc. phosphoric acid, 85% H_3PO_4 .

1 N nitric acid – Dilute 63 ml conc. HNO_3 to 1 liter with distilled water.

2 N nitric acid – Dilute 125 ml conc. HNO_3 to 1 liter with distilled water.

8 N hydrochloric acid – Dilute 667 ml conc. HCl to 1 liter with distilled water.

8 N potassium hydroxide – Dissolve 112 g KOH in 250 ml distilled water.

2 N potassium hydroxide – Dissolve 28 g KOH in 250 ml distilled water.

Sodium hypochlorite – 5% solution NaOCl .

Sodium nitrite solution – Dissolve 1.2 g NaNO_2 in 10 ml distilled water. Prepare fresh immediately before use.

Hydroxylamine hydrochloride – $\text{NH}_2\text{OH} \cdot \text{HCl}$.

Lanthanum nitrate solution – Dissolve 6.2 g $\text{La}(\text{NO}_3)_3 \cdot 6\text{H}_2\text{O}$ in 100 ml 1 N HNO_3 . 1 ml = 20 mg La.

Thenoyltrifluoroacetone solution – Dissolve 5 g thenoyltrifluoroacetone (TTA) in 100 ml benzene.

Procedure

1. To 1 liter urine in a 2-liter beaker, add 20 ml conc. HNO_3 , 5 ml conc. H_3PO_4 , and heat to 85°C.
2. While stirring, add conc. NH_4OH until precipitation occurs. Add 10 ml excess and continue heat and stirring for 1 hr.

3. Cover the beaker and let settle overnight.
4. Decant the supernate, being careful not to disturb the precipitate.
5. Filter the precipitate onto Whatman No. 50 filter paper. Wash the precipitate with 10% NH_4OH . Discard the filtrate.
6. Place filter and precipitate in 50-ml Vycor crucible and ignite at 900°C for 1 hr.
7. Cool residue and add 25 ml 2N HNO_3 . Warm to dissolve residue. Transfer to centrifuge tube with 2N HNO_3 wash, and keep volume less than 50 ml.
8. Cool to room temperature and add 1 g $\text{NH}_2\text{OH}\cdot\text{HCl}$. Stir until it dissolves.
9. Add 1 ml $\text{La}(\text{NO}_3)_3$ solution and adjust volume to 75 ml with 2N HNO_3 .
10. Stir and add 7 ml conc. HF. Let stand 2 min, then remove stirring rods.
11. Let stand 3 min more, then centrifuge and carefully discard the supernate. To residue, add a few ml 2N HNO_3 and stir vigorously.
12. Add 2N HNO_3 in portions, while stirring, until volume is 75 ml.
13. Repeat LaF_3 precipitation by adding 7 ml conc. HF as in step 9, then let stand for 3 min. Centrifuge, and discard the supernate.
14. Break up precipitate with stirring rod and add 2 ml $\text{Al}(\text{NO}_3)_3$ solution. Stir vigorously and add 38 ml more $\text{Al}(\text{NO}_3)_3$.
15. Transfer the solution to a separatory funnel. Add 5 drops NaNO_2 solution and mix. Let stand 15 min.
16. Add 10 ml TTA solution and extract 20 min. Let phases separate and discard aqueous layer.

Note: For a rapid analysis, the TTA can be evaporated on a planchet for counting. Otherwise, proceed to step 17.
17. Add 20 ml distilled water and extract 5 min. Let phases separate and discard aqueous layer. Add 10 ml distilled water and repeat.
18. Add 10 ml 8N HCl and extract 20 min. Let phases separate and drain HCl layer into 50-ml beaker. Repeat extraction.
19. Carefully evaporate the two HCl extracts to 1 ml. Do not boil or let go dry. Cool and add 8N KOH by drops until a pale reddish-brown color appears. Add 5 ml 2N KOH and 2 ml 5% NaOCl solution.
20. Evaporate carefully to one-half original volume. Transfer to electrodeposition cell, washing the beaker once with 1 ml NaOCl solution and three times with distilled water.
21. Connect cell to electroplater and electrolyze 5 hr at 80 mA.
22. Remove cell without interrupting current. Discard solution.
23. Remove disk from cell and wash with distilled water. Let dry and flame lightly. The disk can now be α -counted or autoradiographed.

Autoradiography

Reagents and equipment.

Developer, Kodak D-19.

Fixer, Kodak F-5

Nuclear-track alpha (NTA) plates – 1-in. X 3-in. glass slide with 25- μ emulsion.

NTA exposure camera.

Microprojector – arc illuminated, with 21X objective and 20X ocular.

Chromic acid solution – Dissolve 0.2 g CrO_3 in 1 liter distilled water.

Plate preparation

1. Fill staining dish two-thirds full of CrO_3 solution.
2. In darkroom with red safe light, remove slides from box and place in staining-dish rack. Immerse rack and slides in CrO_3 solution for 4 min. Let drain 5 sec. Turn off red safe light and wash in rinse tank 20 min.
3. Remove rack from wash tank and let slides dry.

Autoradiographic procedure

1. In darkroom with Series AO light filter, load NTA plate in slide depression of camera. Place disk positioner over NTA plates, and drop disks face-down into holes of positioner.
2. Fit top securely on camera, and place camera in dark box. Expose for 1 week.
3. After exposure, develop NTA plates 10 min in D-19 developer at 68°F. Rinse in distilled water and fix 20 min in F-5 fixer.
4. Wash plates for 1 hr and let dry.
5. Count the α tracks with the microprojector. Each projection covers an area of 0.1409 mm^2 , which is called one field. The total area of the exposed NTA plate is 38.82 mm^2 or 277 fields. Tracks are counted on a predetermined number of fields on each plate. Tracks found are compared with a standard curve prepared from urine spiked with known amounts of Pu.

Calculation

Since 1 liter urine sample was used, $\text{dpm Pu/liter urine} = \text{dpm}$ from standard curve.

References

- S. M. Sanders, Determination of Plutonium in Urine, DP-146, March 1956.
L. C. Schwendiman and J. W. Healy, "Nuclear-Track Technique for Low-Level Plutonium in Urine," Nucleonics **16**, 78 (1958).

Procedure 22. Determination of Americium in Urine in the Presence of Plutonium

D. L. Bowkowski (Ref. 53).

Outline of Method

The Pu is co-precipitated with BiPO_4 from acidified urine, the BiPO_4 is wet-ashed with HNO_3 , and the Pu is co-precipitated with LaF_3 from an HCl solution. The LaF_3 co-precipitation is repeated and the fluoride is metathesized with KOH. Pu is extracted into di(2-ethylhexyl)phosphoric acid from a 2 M HNO_3 solution, and the aqueous phase is mounted for counting.

This procedure is included to illustrate the extraction of Pu(IV) into acidic phosphate extractants. The procedure could presumably be used for a simultaneous determination of Pu and Am in urine, by back-extraction of the Pu either into strong acid or a reducing solution.

Reagents

Bromthymol blue indicator solution – Dissolve one g of reagent grade indicator in 500 ml of distilled water made alkaline with one pellet of sodium hydroxide.

Bismuth nitrate solution – Dissolve 231.2 g of bismuth nitrate [$\text{Bi}(\text{NO}_3)_3 \cdot 5\text{H}_2\text{O}$ -AR] in 660 ml of concentrated HNO_3 and dilute to one liter with distilled water. This solution contains 0.1 g of Bi per ml.

4 N HCl – Add 344 ml of conc. HCl to approximately 500 ml of distilled water in a volumetric flask and make up to 1 liter with distilled water.

6 N HCl – Dilute 510 ml of conc. HCl to 1 liter in a volumetric flask.

8 N HCl – Dilute 688 ml of conc. HCl to 1 liter in a volumetric flask.

Lanthanum nitrate solution – $\text{La}(\text{NO}_3)_3$, as received from the Lindsey Chemical Company, West Chicago, Illinois, is freed from actinium α -emitting impurities on a Dowex 50X12 cation exchange resin column by the method of Farabee.* The lanthanum nitrate stock solution obtained is used to prepare working solutions containing 25 mg of La^{+++} /ml. Only solutions containing 0.05 d/min or less of α activity per mg of La^{+++} are used.

2 M Hydroxylamine hydrochloride – Dissolve 139.0 g of C. P. grade hydroxylamine hydrochloride and dilute to one liter. Store in brown bottle.

2 N Sodium nitrite solution – Dissolve 13.8 g of sodium nitrite (NaNO_2 -AR) in distilled water in a 100-ml volumetric flask and make to volume with distilled water. Prepare fresh before use.

0.1 M D2EHPA – Add 32.3 g of di(2-ethylhexyl)phosphoric acid (Union Carbide Chemical Company) to chloroform-AR in a 1-liter volumetric flask and make to volume with chloroform.

8 N KOH – Dissolve 65.3 g of potassium hydroxide (KOH 86%-AR) in distilled water and dilute to 1 liter.

All other chemicals are either of reagent or C. P. quality.

*L. B. Farabee, 5th Ann. Meeting-Bioassay and Analyt. Chem. Grp., Oct. 1-2, 1959 (USAEC Report TID-7591 Nov. 1960 p. 78).

Sample Pretreatment

The volume of a "24-hr equivalent" urine sample (two morning and two evening voidings) is measured and the sample transferred to a 2-liter beaker. The volume and the liquid level are denoted on the beaker with a china-marking pencil or marking pen. Several glass beads, 1 ml of octyl alcohol and 200 ml of concentrated nitric acid are added. The beaker is covered with a Speede-Vap and placed over an asbestos pad on a hot plate at high heat. The sample is digested by gentle boiling until it attains a clear appearance.

BiPO₄ Coprecipitation

A stirring bar is added to the cooled solution and rapid stirring initiated over a magnetic stirring motor. Approximately 130 ml of concentrated ammonium hydroxide are added cautiously, followed by 1 ml of bromthymol blue indicator solution. Neutralization is completed by addition of concentrated ammonium hydroxide to the yellow-green endpoint. If necessary, the sample volume is readjusted to its original value with distilled water. Concentrated nitric acid is added to make the solution 0.15 M in HNO₃ (Table VIII-1). 500 mg of hydroxylamine hydrochloride are added to the solution and the beaker placed in a steam bath heated to 80 ± 5°C. Concentrated phosphoric acid is then added to a concentration of approximately 0.09 M (Table VIII-1). An amount of bismuth nitrate solution, equivalent to 60 mg bismuth per 100 ml, is added dropwise to the heated, stirred solution.

TABLE VIII-1. Solution Requirements for BiPO₄ Precipitation.

Urine volume (ml)	Conc. HNO ₃ for 0.15 M (ml)	H ₃ PO ₄ (ml)	Bi(NO ₃) ₃ soln, (ml)
500	4.8	3.0	3.0
600	5.9	3.6	3.6
700	6.8	4.2	4.2
800	7.5	4.8	4.8
900	8.7	5.4	5.4
1000	9.6	6.0	6.0
1100	10.5	6.6	6.6
1200	11.6	7.2	7.2
1300	12.45	7.8	7.8
1400	13.50	8.4	8.4
1500	14.4	9.0	9.0
1600	15.0	9.6	9.6
1700	16.4	10.2	10.2
1800	17.3	10.8	10.8
1900	18.5	11.4	11.4
2000	19.2	12.0	12.0

The precipitate is digested by an additional hour of stirring at 80 ± 5°C. The sample beaker is removed from the water bath and allowed to stand undisturbed for a minimum of 3 hr. The supernatant solution is carefully aspirated off (avoid disturbing precipitate) and the precipitate transferred to a 90-ml Pyrex centrifuge tube with a distilled water rinse. The precipitate is centrifuged for 5 min at 2000 rpm and the supernate carefully discarded. The sample beaker walls are then rinsed down with 4 N HCl from a wash bottle and the rinse transferred to the 90-ml tube. The final volume in the tube should be approximately 50 ml.

Wet-ashing of Bismuth Phosphate

Several drops of octyl alcohol are added to the HCl solution in the 90-ml tube; it is placed in an aluminum block at approximately 100°C, and the solution taken to dryness. The dried sample is then repeatedly wet-ashed with several drops of

concentrated nitric acid in a block heated to 350°C. After the sample has ashed to whiteness, it is evaporated twice with 8 N HCl.

Lanthanum Fluoride Coprecipitation

The bismuth chloride ash is dissolved in 8 ml of 8 N HCl and the solution is transferred to a 25-ml conical centrifuge tube. The walls of the 90-ml tube are rinsed with an additional 2 ml of 4 N HCl and the rinse added to the centrifuge cone. After addition of 0.1 ml of $\text{La}(\text{NO}_3)_3$ solution, the tube contents are mixed thoroughly. Two ml of concentrated hydrofluoric acid (27 M) are then added, and the solution stirred with a Pt stirrer. The tube is allowed to stand for 5 min and then centrifuged at 2000 rpm for 3 min. The supernatant is carefully aspirated and the precipitate dissolved in 2 ml of concentrated HCl.

Following the addition of 2 ml of distilled water, LaF_3 is reprecipitated by addition of 2 ml of 27 M HF. The preceding digestion and centrifugation steps are repeated. Five ml of 8 N potassium hydroxide are added to the precipitate and carefully heated to boiling. After cooling the mixture is centrifuged for three minutes and the supernate carefully drawn off.

D2EHPA Extraction

Following solution of the precipitate in 6 ml of 2 N HNO_3 , one ml of 2 M hydroxylamine hydrochloride is added, and the sample is heated in a water bath at 70°C for 5 min. The tube is then removed from the water bath and 2 ml of 2 M sodium nitrite solution are added with swirling. When bubble evolution ceases, the solution is transferred to a 30-ml separatory funnel. The centrifuge tube is rinsed once with 3 ml of 2 N nitric acid and the rinse added to the separatory funnel. The aqueous layer is then extracted thrice with 5-ml portions of 0.1 M D2EHPA in chloroform for 5-min periods. The chloroform extracts are removed and the aqueous layer is shaken for 3 min with a 5-ml portion of toluene. The aqueous portion is then withdrawn through the funnel stem into another 25-ml conical centrifuge tube. Lanthanum fluoride is precipitated by addition of 2 ml of 27 M HF. The solution is allowed to stand 5 min centrifuged at 2000 rpm for 3 min and the supernatant drawn off and discarded. Shake the precipitate with 10-15 ml of 1:100 hydrofluoric acid wash solution and centrifuge at 2000 rpm for 5 min.

Sample Planchetting

Aspirate the supernatant and invert the centrifuge cone quickly over absorbent tissue. Drain 15 min. Slurry the precipitate with distilled water and transfer to a stainless steel planchet with a disposable capillary pipette. Dry the disk under an infrared lamp and flame the dried planchet to red heat. The α activity is then counted with a low-background proportional counter for 150 min.

Procedure 23. Determination of Plutonium in Urine by Anion Exchange E. D. Campbell and W. D. Moss (Ref. 74)

Outline of Method

Pu is concentrated from urine by co-precipitation with alkaline earth phosphates. The precipitate is dissolved in 7.5 N nitric acid and the Pu absorbed from that solution onto Dowex 1 X 2 anion exchange resin. Interfering anions absorbed on the column are removed with 12 N HCl. The Pu is eluted from the column with specially prepared hydrochloric and hydriodic acids, and the α activity determined by direct plancheting or by electrodeposition of the eluate, followed by standard α -counting techniques.

Equipment

Ion exchange column. The ion exchange column container consists of a glass reservoir, 2-5/8 in. long by 1-3/32 in. i. d., capacity 40 ml, on a chromatographic column tube 3 in. long by 5/16 in. i. d., constricted at the tip.

Solutions

Hydriodic acid stock solution. Prepared by distilling hydriodic acid (analytical reagent grade, 5.5 M in hydriodic acid, 1.5% hypophosphorous acid preservative) under nitrogen. The hypophosphorous acid preservative interferes with the electrodeposition step and also with the preparation of satisfactory plancheted samples. Oxidation of the prepared hydriodic acid solution is inhibited by adding enough hydrazine (up to 20% by volume of 64% to 84% hydrazine in water) to decolorize the hydriodic acid solution.

Hydrochloric acid-hydriodic acid elutriant. Prepared by mixing 1 ml of hydriodic acid stock solution with 9 ml of concentrated hydrochloric acid. The precipitate formed by hydrazine is removed by centrifuging; the supernatant then is saturated with gaseous hydrogen chloride. The reagent must be prepared every few days because it decomposes easily.

Reagents

All other reagents used in the procedure are prepared from analytical grade chemicals.

Preparation of Ion Exchange Column

A glass wool pledget in the tube supports the resin. The tube is filled with from 2-1/2 to 3 in. of a distilled water slurry of Dowex AG1-X2, chloride form, 50 to 80 mesh, anion exchange resin (Bio-Rad Laboratories, 32nd and Griffin, Richmond, Calif.). The resin in the column is converted to the nitrate form by washing with at least two 5 ml portions of 7.5 N nitric acid before adding the sample solution. The resulting column flow rate is 1 ml/min.

Preparation of Sample

The 24-hr or equivalent urine sample is transferred to a 2-liter graduated cylinder with concentrated nitric acid (50 ml of acid per liter). The cylinder is heated in a steam bath at 75 to 80°C, and stirred with a magnetic stirrer, for 30 min. One ml of phosphoric acid is added to the sample, then enough concentrated ammonium hydroxide to form a copious precipitate, and the sample is digested, with continuous stirring, for 1 hr. After 30 min of digestion the stirrer is stopped, the precipitate is allowed to settle for several minutes, and the clear supernatant is treated with several ml of ammonium hydroxide to be sure precipitation is complete. Should more precipitate form, an excess of ammonium hydroxide is added, and the stirring is continued for the remaining 30 min. After the cylinder is removed from the water bath and the stirring bar from the cylinder, the sample is allowed to remain undisturbed overnight at room temperature.

The following morning the supernatant is aspirated from the precipitate and discarded. The alkaline earth phosphate precipitate is transferred to a 90-ml centrifuge tube with distilled water and centrifuged. The supernatant is discarded, the cylinder is washed with dilute (20%) nitric acid, and the washings are combined with the precipitate in the tube. The material in the tube then is evaporated to dryness in an aluminum heating block at 85 to 90°C, and the residue finally is whitened with concentrated nitric acid at approximately 300°C.

Ion Exchange Isolation of the Pu

The ashed residue from the alkaline earth phosphate precipitate is dissolved in 25 ml of 7.5 N nitric acid. The residue may be dissolved with heat if necessary, but will dissolve easily at room temperature overnight (preferred method). The acid solution is transferred to the reservoir of a prepared ion exchange column and allowed to drain completely. The centrifuge tube is rinsed with three 5-ml portions of 7.5 N nitric acid, each rinse being allowed to drain through the column before the next is added. The column reservoir then is washed down with 5 ml of 7.5 N nitric acid, which is allowed to drain through the column completely. Three ml of concentrated hydrochloric acid are added carefully to the top of the resin without disturbing the resin, keeping dilution from the 7.5 N nitric acid to a minimum, and allowing the hydrochloric acid to drain completely. All effluents from the absorption and washing steps are discarded.

One to two ml of 0.5 N HCl are added to the top of the column, the first several drops discarded, and the remaining eluate retained in a 15-ml centrifuge tube. The column then is eluted with two 5 ml portions of 0.5 N HCl and allowed to drain completely into the centrifuge tube. Finally, several crystals of hydroxylamine hydrochloride are added to the top of the resin and 2 ml of hydriodic-hydrochloric acid solution drained through the column and collected.

NOTE: The hydroxylamine hydrochloride is added to the column to prevent immediate oxidation of the hydriodic acid. An excess of hydriodic-hydrochloric acid

solution should not be used because of possible interference in the electrodeposition step. The eluate in the tube then is evaporated to approximately 1 ml in an aluminum heating block at 75°C.

Electrodeposition

The residue from the vaporation is neutralized with 8 N potassium hydroxide using phenolphthalein as indicator. When the solution is neutral, 2 ml of sodium hypochlorite and 5 ml of 2 N potassium hydroxide are added to the tube, and the contents of the tube transferred to an electrodeposition cell with distilled water. (The final concentration of the alkali is 1 N.) The Pu is electrodeposited on 1/2 in. polished stainless steel disks at 200 mA for 5 hr. The apparatus and techniques for the electrodeposition of Pu are described by Schwendiman et al.*

Determination of Alpha Activity

The α activity on the stainless steel plates can be determined either by the NTA (Nuclear Track Alpha) emulsion method or by the standard electronic counting method. The background of the NTA method is 0.007 dpm, with an accuracy of 1.6 dpm. A method of choice for more rapid evaluation of results is the electronic determination of the α activity by the phosphor-coated mylar method described by Hallden and Harley.** The phosphor method uses a 1-in. photomultiplier tube and an all-transistorized amplifier and counter system designed by P-1 (the Electronics Group of the Los Alamos Scientific Laboratory's Physics Division), similar to that described by Graveson et al.*³ The background of this system is 0.015 cpm when adjusted to an optimum efficiency of 45%. The precision of this counting is satisfactory for 0.1 dpm.

*L. C. Schwendiman, J. W. Healy, D. L. Reid, and G. E. Hanford, HW-22680 (1951).

**N. A. Hallden and J. H. Harley, *Analyt. Chem.* 32, 1861 (1960).

*³R. T. Graveson et al., AEC New York Operations Office, Rpt. NYO 1523 (1950). (TID ORE, Oak Ridge, Tenn.)

Procedure 24. Determination of Plutonium in Urine by Co-crystallization with Potassium Rhodizonate W. H. Shipman and H. V. Weiss (Ref. 374)

Outline of Method

Pu is co-crystallized with potassium rhodizonate by adding an equal volume of ethyl alcohol to a pH 9 solution of the reagent in urine. The Pu is further purified by co-precipitation with LaF_3 and adsorption on an anion exchange resin. The Pu is eluted with 6 N HCl - 0.2 N HF, electrodeposited and α -counted.

Reagents

Potassium rhodizonate (Paul B. Elder Co., Bryan, Ohio).

Dowex anion exchange resin AG1-X8 (Bio-Rad Laboratories, Richmond, Calif.).

Lanthanum carrier solution. Lanthanum nitrate was dissolved in water and purified from interfering α activity by passage through the anion exchange column after adjusting the HCl content to 10 N. Excess HCl was removed by evaporation and the salt was dissolved in 2 N HNO_3 to a final concentration of 5 mg of La^{+++} per ml.

All other chemicals were either of reagent grade or C. P. quality.

Procedure

Based upon the experimental results, the following analytical procedure was evolved: The procedure is described for a 500-ml sample volume. For a different volume, reagents are used in proportionate amounts.

Add 1 g of potassium rhodizonate to the sample. (If the urine is not fresh, solubilization of the reagent may be difficult. Under such circumstances acidification of the sample with HCl to pH 2 to 3 effects rapid solution.) Adjust to pH 9 with 5 N NaOH and crystallize the rhodizonate with 500 ml of absolute ethyl alcohol. Let stand for several minutes and isolate the crystals by centrifugation.

Dissolve the crystals in 50 ml of 2 N HNO_3 . Add 1 ml of lanthanum carrier (5 mg of La^{+++} per ml) and precipitate with 30 ml of 27 N HF. Centrifuge. Without separating the precipitate from the liquid, add 0.5 ml of lanthanum carrier with stirring to the supernatant liquid and centrifuge. Discard the supernatant liquid.

Dissolve the precipitate in 5 ml of saturated H_3BO_3 and 5 ml of concentrated HCl. Add about 10 ml of distilled water and make alkaline with concentrated NH_4OH . Centrifuge. Without separating the precipitate from the liquid, add 0.5 ml of lanthanum carrier with stirring to the supernatant liquid. Centrifuge. Discard the supernatant liquid.

Dissolve the precipitate in a small volume of concentrated HNO_3 , add about 15 ml of water, and reprecipitate with concentrated NH_4OH . Centrifuge. Without separating the precipitate from the liquid, add 0.5 ml of lanthanum carrier with stirring to the supernatant liquid. Centrifuge. Discard the supernatant liquid.

Dissolve the precipitate in concentrated HNO_3 . Add about 3 ml of concentrated H_2SO_4 and heat to dryness.

Dissolve the salts in 10 to 15 ml of 6 N HCl. Add 0.5 ml of 0.4 N NaNO_2 and make 9 N with concentrated HCl. Let stand 5 min.

Pour the solution through a Teflon column, 4 × 0.62 cm anion exchange resin AG 1-X8 (Cl⁻: 0.297 to 0.144 mm) previously washed with 10 ml of 9 N HCl. Adjust the flow rate to 2 ml/min.

Wash the column with 15 ml of 9 N HCl. Elute with 30 ml of 6 N HCl-0.2 N HF. Collect the eluate in a Teflon beaker which contains 15 mg of NaCl. Evaporate to dryness. Dissolve the salt in concentrated HNO₃ and transfer to glass. Add 3 ml of HClO₄, 2 ml of H₂SO₄, and heat to dryness.

Dissolve the salt in 1 ml of water and transfer to the electrodeposition cell fitted with a tantalum disk. Add 4 ml of 6 N NH₄Cl solution and 2 drops of concentrated HCl.

Electrodeposit at 2.5 to 3.0 A for 20 min. Quench the cell with 1 ml of concentrated NH₄OH. Wash the solution from the cell with distilled water and dry the tantalum disk on a hot plate.

Alpha count.

Procedure 25. Determination of Plutonium in Urine and Bone Ash by Extraction with Primary Amines F. W. Bruenger, B. J. Stover, and D. R. Atherton (Ref. 61)

Outline of Method

Concentrated urine, or a solution of bone ash is made 1 M in H_2SO_4 and Pu is extracted by a mixture of highly branched primary alkyl amines. The Pu is then back-extracted with 8 M HCl and counted.

Reagents and Equipment

The α -detection instrument is a 2π proportional counter of conventional design capable of accepting 2-in. stainless steel planchettes; counter performance is checked with a U_3O_8 standard supplied by the National Bureau of Standards.

Primene JM-T, a mixture of tert-alkyl primary amines, 5% by volume in xylene, was purchased from Rohm and Haas, Philadelphia, Pa. The Primene solution is washed with half its volume of 1 M H_2SO_4 before use.

Procedure

Urine analysis. Urine is collected in polyethylene bottles over 10 ml of concentrated formic acid to avoid excessive hydrolysis of urea, which would render the specimen basic and could result in loss of Pu by adsorption on the wall of the container. An aliquot of urine is transferred to a Kjeldahl flask containing enough 5 M H_2SO_4 to attain an acid concentration of 2 M in the final sample. The solution is boiled without charring for about 1 hr. Thus far, volumes up to 500 ml have been extracted. For larger volumes, amounts of reagents are increased proportionally. The following amounts of reagents are used for 100-ml aliquots. The sample is filtered through borosilicate glass wool into a separatory funnel and is allowed to cool to room temperature. Twenty ml of a 5% solution of Primene JM-T in xylene is added to the sample and the mixture is shaken for 15 min. After separation of the two phases, the aqueous phase is put aside for a second extraction. The organic phase is washed twice with 25 ml of 1 M H_2SO_4 . Pu is removed from the organic phase with two 20-ml portions of 8 M HCl. The aqueous phase is again extracted with 20 ml of 5% Primene, and Pu is back-extracted from the Primene with 20 ml of 8 M HCl. The combined HCl fractions are dried under a heat lamp and then the organic contaminants are destroyed by heating over an open flame or in a furnace at 500°C. The Pu residue is dissolved in concentrated HNO_3 and transferred to a 2-in. -diameter stainless steel planchette for α counting.

Bone analysis. Bone is ashed for 4 hr at 600°C and, after cooling, is dissolved in as little HNO_3 as possible and diluted with H_2O to a known volume, and a suitable aliquot of this solution is taken for analysis. The amount of bone ash should not exceed 250 mg for every 75-ml volume of the aqueous phase. The aliquots are evaporated to dryness under a heat lamp to minimize the amount of HNO_3 and then put in solution with 4 ml of concentrated $HCOOH$, and a 60-ml portion of 2.5 M H_2SO_4 is added. This solution is heated in a water bath until it is clear, and then transferred to a separatory funnel. Transfer is completed with a 10-ml rinse of distilled water. Any $CaSO_4$ that forms does not interfere. Pu is extracted as described above.

Glossary

- A/CONF. 8/ Vols. 1-17 - Proceedings of the International Conference on Peaceful Uses of Atomic Energy, held in Geneva, August 1955 (United Nations, New York, 1958).
- A&CONF. 15/1 English Ed. Vols. 1-33 - Proceedings of the Second United Nations International Conference on Peaceful Uses of Atomic Energy, held in Geneva, September 1958 (United Nations, Geneva, 1958).
- AEC - Atomic Energy Commission
- AEC - Manhattan District and later Washington, D. C. AEC declassified reports.
- MDDS - Manhattan District, Oak Ridge, Tenn.
- TID - Technical Information Division, Oak Ridge, Tenn.
- AECL - Atomic Energy of Canada, Ltd., Chalk River, Ontario.
(also CEI- and CRDC- prefixes followed by number.)
- ANL - Argonne National Laboratory, Illinois.
- CEA - France. Commissariat a l'Energie Atomique, Paris.
- CEA-TR - Series assigned by the AEC to translations received from CEA.
- DP - E. I. du Pont de Nemours and Co., Savannah River Laboratory, Aiken, So. Carolina.
- EURAEAC - United States - Euratom Joint Research and Development Program.
- HW - General Electric Co., Hanford Atomic Products Operation, Richland, Wash.
- JENER - Joint Establishment for Nuclear Energy Research, Kjeller, Norway.
- KAPL - Knolls Atomic Power Laboratory, Schnectady, New York.
- LASL - Los Alamos Scientific Laboratory, New Mexico.
(LA-, LAMS-, and LADC- prefixes followed by number.)
- ORNL - Oak Ridge National Laboratory, Tennessee.
- USNRDL - U. S. Naval Radiological Defense Laboratory, San Francisco, Calif.
- UKAEA - United Kingdom Atomic Energy Authority.
- AEEW - Research Group, Atomic Energy Establishment, Winfrith, Dorset.
- AERE - Atomic Energy Research Establishment, Harwell, Berks.
- AHSB(RP) - Health and Safety Branch, Radiological Protection Div., Harwell, Berks.
- AWRE - Great Britain Atomic Weapons Research Establishment, Aldermaston, Berks.
- DEG-INF-SER - Development and Engineering Group, Risley, Warrington, Lancs.
- IGO & IGR - Industrial Group Hdqtrs., Risley, Warrington, Lancs.
- PG - Production Group, Risley, Warrington, Lancs.
- Books Referenced:
- "The Transuranium Elements" (McGraw-Hill Book Co., Inc., New York, 1949).
G. T. Seaborg, J. J. Katz and W. M. Manning, Eds.

"The Actinide Elements" (McGraw-Hill Book Co., Inc., New York, 1954).

G. T. Seaborg and J. J. Katz, Eds.

"Progress in Nuclear Energy Series III. Process Chemistry" (McGraw-Hill Book Co., Inc., New York, 1956-61).

"Progress in Nuclear Energy Series V. Metallurgy and Fuels" (Pergamon Press, Ltd., London, 1956-61).

References

NOTE: The first 19 references are contained in Sections I and II at the beginning of this monograph.

20. A. W. Adamson, Clinton Labs., Oak Ridge, Tenn. CN-2224, Jan. 1945.
21. S. Ahrland, I. Grenthe, and B. Noren, Acta Chem. Scand. **14**, 1077 (1960).
22. S. Ahrland, I. Grenthe, and B. Noren, Acta Chem. Scand. **14**, 1059 (1960).
23. A. M. Aiken, Chem. Engr. Progr. **53**, 82 (1957).
24. A. M. Aiken, M. Moss, and T. Bruce, AECL-1786, 1951.
25. K. Alcock, F. C. Bedford, W. H. Hardwick, and H. A. C. McKay, J. Inorg. Nucl. Chem. **4**, 100 (1957).
26. K. Alcock, G. F. Best, E. Hesford, and H. A. C. McKay, J. Inorg. Nucl. Chem. **6**, 328 (1958).
27. I. F. Alendrikova, L. L. Zaitseva, L. V. Lipis, N. S. Nikolayev, V. V. Formin, and N. T. Chebotared, Zh. Neorgan. Khim. **3**, 951 (1958). English transl. AEC-tr-3505.
28. H. W. Alter, W. D. Haas, and E. I. Zebroski, KAPL-442, 1950.
29. H. W. Alter and E. Zebroski, KAPL-314, 1950.
30. F. Anselin, P. Faugeras, and E. Grison, Compt. Rend. **242**, 1996 (1956).
31. C. B. Amphlett, A/CONF. 15/1, Vol. 28, p. 17, Paper 271.
32. G. J. Appleton and H. J. Dunster, UKAEA, AHSB(RP) R. 6, 1961.
33. M. E. D. Bains, UKAEA, AEW-R-292, 1963.
34. R. J. Baltisberger, Anal. Chem. **36** 2369 (1964).
35. F. Baroncelli, G. Scibona, and M. Zifferero, J. Inorg. Nucl. Chem. **25**, 205 (1963)
36. F. Baroncelli, G. Scibona, and M. Zifferero, Radiochim. Acta **1**, 75 (1963).
37. L. J. Beaufait, Jr. and H. R. Lukens, Jr., "Handbook of Radiochemical Analysis, Vol. II. Radiochemical Procedures," NP-5056 (del.), Tracerlab, Inc., Richmond, Calif., 1952.
38. M. Beran and S. Havelka, Collection Czech. Chem. Commun. **28**, 2510 (1963). In German.
39. K. S. Bergstresser and G. R. Waterbury, LASL, LA-3091, 1964.
40. M. G. Berkman and L. Kaplan, ANL-4573, Jan. 1951.
41. B. Bernstrom and J. Rydborg, Acta Chem. Scand. **11**, 1173 (1957).
42. U. Bertocci, UKAEA, AERE-R-2933, May 1959.
43. G. F. Best, E. Hesford, and H. A. C. McKay, J. Inorg. Nucl. Chem. **12**, 136 (1959).
44. G. F. Best, H. A. C. McKay, and P. R. Woodgate, J. Inorg. Nucl. Chem. **4**, 315 (1957).
45. T. K. Bierlein, L. F. Kendall, and H. H. van Tuyl, HW-25074, 1952.
46. R. E. Biggers and D. A. Costanzo, ORNL-TM-580, 1963.
47. H. Bildestein et al., "Destructive Analysis of Unirradiated and Irradiated Fuels" Osterreichische Studiengesellschaft fuer Atomenergie, Vienna, SGAE-CH-8/1964.

48. D. H. Boase, J. K. Foreman, and J. L. Drummond, Talanta **9**, 53 (1962).
49. N. A. Bonner and M. Kahn, "Radioactivity Applied to Chemistry" (John Wiley and Sons, New York, 1951) Chap. 6.
50. M. Bonnevie-Svendsen, "Reprocessing Analysis", JENER-59, 1959.
51. Z. Borkowska, M. Millcarski, and M. Taube, J. Inorg. Nucl. Chem. **26**, 359 (1964).
52. D. F. Bowersox, LASL, LAMS-2884, Feb. 1963.
53. D. Bowkowski, Am. Indust. Hygiene Assoc. J., **25**, 59 (1964).
54. M. Branica and E. Bona, A/CONF. 15/1 Vol. 17, p 172, Paper 2412.
55. J. K. Brody, J. P. Faris, and R. F. Buchanan, Anal. Chem. **30**, 1909 (1958).
56. R. O. R. Brooks, UKAEA, AERE-AM-60, (see also, Smales et al., AERE-C/R-533).
57. R. E. Brooksbank and W. T. McDuffee, ORNL-3566, 1964.
58. K. B. Brown, Progr. Nucl. Energy Ser. III, Vol. 2, Appendix IV, p 557.
59. K. B. Brown, K. A. Allen, C. A. Blake, C. F. Coleman, D. J. Crouse, A. T. Gresky, and B. Weaver, ORNL-CF-60-1-119, 1960.
60. F. R. Bruce, Progr. Nucl. Energy Ser. III, Vol. 2, Chapt. 8-3, p 363.
61. F. W. Bruenger, B. J. Stover, and D. R. Atherton, Anal. Chem. **35**, 1671 (1963). (See also Bruenger, et al., COO226, AEC Chicago Opns. Office, (1962) p 58.
62. L. E. Bruns and C. W. Nilsen, HW-70084, June 1961.
63. A. Brunstad, HW-51655, July 1957.
64. A. Brunstad, HW-54203, 1957.
65. A. Brunstad and R. C. Smith, HW-52796, Sept. 1957.
66. R. F. Buchanan, J. P. Faris, K. A. Orlandini, and J. P. Hughes, AEC Div. of Tech. Infor., Oak Ridge, Tenn., TID-7560, June 1958, pp 179-88.
67. J. S. Buckingham, C. A. Cavin, and C. A. Goodall, HW-59283, Feb 1959.
68. L. R. Bunney, N. E. Ballou, J. Pascual, and S. Foti, USNRDL-TR-228, May 1958.
69. L. L. Burger, HW-44888, 1957.
70. L. L. Burger, J. Phys. Chem. **62**, 590 (1958).
71. L. L. Burger, I. M. Rehn and C. M. Slansky, HW-19949, 1952.
72. J. P. Butler and J. S. Merritt, AECL-353, Aug. 1956.
73. F. A. Cafasso, H. M. Feder, and I. Johnson, J. Phys. Chem. **68**, 1944 (1964).
74. E. E. Campbell and W. D. Moss, LASL, LADC-5922, 1963.
75. M. H. Campbell, HW-68003, Jan. 1961.
76. G. Carleson, A/CONF. 8/17, p 111, Paper/137.
77. G. Carleson, Svensk Kemisk Tidskrift **70**, 55 (1958).
78. S. C. Carniglia, Clinton Labs., Oak Ridge, Tenn., CN-3339, Aug. 1945.
79. W. N. Carson, Jr., H. S. Gile, and J. W. Vandewater, HW-39110, Sept. 1955.
80. D. J. Carswell, J. Inorg. Nucl. Chem. **3**, 384 (1957).

81. D. J. Carswell and J. Milstead, J. Nucl. Energy 4, 51 (1957).
82. M. Cefola and W. S. Andrus, KAPL-M-MC-2, Sept. 1949.
83. R. B. Chenley, G. J. Hunter, and T. J. Webber, UKAEA, AERE-C/M-327, 1958.
84. A. Chesné, Bull. Inform. Sci. Tech. (Paris), No. 66, pp 58-64, Nov. 1962. In French.
85. A. Chesné, G. Koehly, and A. Bathellier, Nucl. Sci. Eng. 17, 557 (1963).
86. A. Chetham-Strode, Jr., Lawrence Radiation Laboratory, Berkeley, Calif. UCRL-3322, 1956.
87. M. K. Chmutova, O. M. Petrukhin, and Yu. A. Zolotov, Zh. Analit. Khim. 18, 588 (1963). In Russian.
88. E. L. Christenson, C. W. Kellrey, A. J. Bearmint, and J. R. Humphrey, "Extractive and Physical Metallurgy of Pu and its Alloys" (Interscience Publishers, New York, 1960) W. D. Williams, Ed. pp 75-88.
89. E. G. Chudinov and G. N. Yakovlev, Radiokhimiya 4, 506 (1962). In Russian.
90. F. Clanet, J. Chromatog. 6, 85 (July 1961). In French.
91. F. Clanet, J. Clarence, and M. Verry, J. Chromatog. 13, 440 (1964). In French.
92. J. W. Coddling, W. O. Haas, Jr., and F. K. Heumann, KAPL-602, Nov. 1951.
93. J. W. Coddling, W. O. Haas, Jr., and F. K. Heumann, Ind. Eng. Chem. 50, 145 (1958).
94. A. S. Coffinberry and M. B. Waldron, Progr. Nucl. Energy Ser. V, Vol. 1, pp 354-410.
95. C. F. Coleman, K. B. Brown, J. G. Moore, and D. J. Crouse, Ind. Eng. Chem. 50, 1756 (1958). (See also Coleman, Brown, Moore, and K. A. Allen, A/CONF.15/1, Vol. 28, p 278 Paper/510.)
96. C. A. Colvin, HW-79354, Oct. 1963.
97. A. E. Comyns, Chem. Rev. 60, 115 (1960).
98. W. V. Conner, Dow Chemical Co., Rocky Flats Div., Golden, Colo. RFP-356, Feb. 1964.
99. R. E. Connick, J. Am. Chem. Soc. 71, 1528 (1949).
100. R. E. Connick and W. H. McVey, J. Am. Chem. Soc. 75, 474 (1953).
101. O. A. Cook, in "The Transuranium Elements", Vol. 14B, p 147, Paper/3.5.
102. G. P. Cook and O. Jones UKAEA IGO-AM/W-68, Jan. 1957.
103. J. Coppel and F. Regnaud, Anal. Chim. Acta 27, 36-9 (1962). In French. (English transl. HW-TR-45.)
104. D. A. Costanzo and R. E. Biggers, ORNL-TM-585, July 1963.
105. H. W. Crandall, J. R. Thomas, and E. Zebroski, AEC-TID-10022, Aug. 1947.
106. I. H. Crocker, AECL, CRDC-697, May 1957 (AECL-488).
107. H. W. Crocker, HW-68655, Feb. 1961.

108. E. A. C. Crouch and G. B. Cook, J. Inorg. Nucl. Chem. **2**, 223-8 (1956).
109. F. L. Culler, Progr. Nucl. Energy Ser. III, Vol. 1, Chap. 5-2, p 172; Chap. 5-4, p 201. (See also A/CONF. 8/9, p 464, 560, Paper/822.)
110. J. G. Cuninghame and G. L. Miles, J. Inorg. Nucl. Chem. **3**, 54 (1956).
111. J. G. Cuninghame and G. L. Miles, J. Appl. Chem. **7**, 72 (1957).
[See also same authors, J. Inorg. Nucl. Chem. **3**, 54 (1956).]
112. D. Cvjetcanin, "Separation of U(VI), Pu(VI), and Pu(IV) from Zr and Nb on a Column of Silica Gel," JENER-57, Aug. 1958.
113. D. Cvjetcanin and N. Cvjetcanin, "Separation of U and Pu from Zr, Nb, Ru, and Cs on a Column of MnO₂," JENER-54, April 1958.
114. D. H. W. den Boer and Z. I. Dizdar, "On the Isolation of Pu by a Solvent Extraction Procedure," JENER-45, Oct. 1956.
115. C. Deptula and S. Mine, Nukleonika **6**, 197 (1961).
116. M. deTrentinian and A. Chesné, "Extraction and Purification of Pu with a Tertiary Amine," France. Commissariat A l'Energie Atomique, Paris, Rappt. No. 1426, 1960.
117. R. M. Diamond, K. Street, Jr., and G. T. Seaborg, J. Am. Chem. Soc. **76**, 1461 (1954).
118. G. A. Dupetit and A. H. W. Aten Jr., Radiochim. Acta **1**, 48 (1962).
119. R. W. Durham and A. M. Aiken, AECL, CEI-55, Feb. 1953. (Reprinted July 1960.)
120. R. W. Durham and R. Mills, AECL, CEI-62, (Rev.), Revised and reprinted, AECL-1399, Oct. 1961.
121. Ph. Dreze and G. Duyckaerts, Liege Universite, Brussels, EUR-436.f, 1963.
122. M. A. El Guebely and T. Sikkeland, Acta Chem. Scand. **11**, 473 (1957).
123. F. Elliott and G. W. Pearson, Nucleonics **21**, 78 (1963).
124. H. Eschrich, Institutt for Atomenergi, Kjeller, Norway, KR-11, 1961.
125. R. J. Everett, L. W. Brewer, G. W. Edwards, A. J. Jack, T. A. Linn, Jr., and R. O. Mills, Sandia Corp., Albuquerque, N. Mex. SC-4783 (RR), Feb. 1964.
126. L. B. Farabee, Clinton Labs., Oak Ridge, Tenn., MON-H-218, 1947.
127. J. P. Faris, ANL-6275; and Faris and R. F. Buchanan, ANL-6811, 1964.
128. P. Faugas and M. Heuberger, "Nouveau Traite de Chemie Minerale," (Masson et cie, Paris, 1962) Vol. XV, p 661.
129. C. Ferradini and J. Coppel, CEA-791, 1958.
130. J. R. Ferraro, G. W. Mason, and D. F. Peppard, J. Inorg. Nucl. Chem. **22**, 285, 291 (1961).
131. R. M. Fink and K. F. Fink, University of California, Los Angeles, UCLA-30, 1949.
132. J. R. Flanary, A/CONF. 8/9, pp 528-31, Paper/539.
133. J. M. Fletcher, Progr. Nucl. Energy Ser. III, Vol. 1, Chap. 4-1, p 105.

134. V. V. Fomin, R. E. Kartushova, and T. I. Rudenko, J. Nucl. Energy **4**, 247 (1957).
135. A. Fontaine, L. Baude-Malfosse, and M. Cunz, CEA-1977, 1961.
136. S. C. Foti and E. C. Freiling, USNRDL-TR-444, July 1960. [See also Talanta **11**, 385 (1964).]
137. E. L. Francis, UKAEA, IGR-161 (Rd/R), 1959.
138. N. H. Furman, W. B. Mason, and J. S. Pekola, Anal. Chem. **21**, 1325 (1949).
139. I. J. Gal and O. S. Gal, A/CONF/15/1, Vol. 28, p 24, Paper/468.
140. I. Gal and Aleksandar Ruvarac, Bull. Inst. Nucl. Sci. "Boris Kidrich" (Belgrade), **13**, No. 1, 1-17 (Apr. 1962). In English. [See also J. Chromatog., **13**; 549 (1964).]
141. M. Ganivet, CEA-1592, June 1960. In French.
142. H. B. Garden and E. Nielsen, in "Annual Review of Nuclear Science," (Annual Reviews, Inc., Palo Alto, California, 1957) Vol. 7, p 47.
143. N. R. Geary, UKAEA, RISLEY-8142, 1955.
144. E. L. Geiger, Health Phys. **1**, 405 (1959).
145. A. S. Ghosh Mazumder, P. V. Balakrishnan, and R. N. Singh, Lawrence Radiation Laboratory, Livermore, California, UCRL-trans-938(L). Transl. from Vijnana Parishad Anusandhan Patrika **4**, 149 (1961).
146. J. E. Gindler, J. Gray, Jr., and J. R. Huizenga, Phys. Rev. **115**, 1271 (1959).
147. L. E. Glendenin, K. F. Flynn, R. F. Buchanan, and E. P. Steinberg, Anal. Chem. **27**, 59 (1955).
148. B. Goldschmidt, P. Regnaut, and I. Prevot, A/CONF.8/9, pp 492-7, Paper/349.
149. P. D. Goulden, R. W. Durham, and V. Corriveau, AECL, CRDC-640, (also AECL-348) March 1955.
150. D. W. Grant, J. Inorg. Nucl. Chem. **6**, 69 (1958).
151. V. I. Grebenshchikova and V. N. Bobrova, Radiokhimiya **3**, 544 (1961). In Russian.
152. V. I. Grebenshchikova and N. B. Chernyavskaya, Radiokhimiya **4**, 232 (1962). In Russian.
153. C. Groot, I. M. Rehn, and C. M. Slansky, HW-19303, Dec. 1950.
154. D. M. Gruen, S. Fried, P. Graf, and R. L. McBeth, A/CONF.15/1, Vol. 28, p 112, Paper/940.
155. J. E. Guthrie and W. E. Grummitt, AECL, AECL-1745, May 1963.
156. R. Gwozdz and S. Siekierski, Polish Academy of Sciences, Inst. of Nuclear Research, 168/V, 1960. Also Nukleonika **5**, 671 (1960).
157. E. Haeffner and A. Hultgren, Nucl. Sci. and Eng. **3**, 471 (1958).
158. G. R. Hall and R. Hurst, UKAEA, AERE C/M 88 (Rev), 1950.

159. J. W. Handshuh, HW-66441, 1960.
160. G. C. Hanna, in "Experimental Nuclear Physics" (John Wiley and Sons, New York, 1959), E. Segré, Ed. Vol. III, p 54.
161. W. H. Hardwick and F. Bedford, UKAEA, AERE-C/M-112, 1981.
162. C. J. Hardy, Progr. Nucl. Energy Ser. III, Vol. 2, Chap. 8-2, p 357.
163. C. J. Hardy, D. Scargill and J. M. Fletcher, J. Inorg. Nucl. Chem. 7, 257 (1958).
164. K. M. Harmon and W. H. Reas, Progr. Nucl. Energy Ser. III, Vol. 2, Chap. 4-8, p 184. (Also HW-49597 A.)
165. R. G. Hart, AECL, CRDC-630, 1957.
166. R. G. Hart, AECL, CRDC-822, 1959.
167. R. G. Hart, M. Lounsbury, C. B. Bigham, L. V. P. Corriveau, and F. Girardi, AECL, CRP-761, 1959. [See also Talanta 6, 94 (1960).]
168. S. Havelka and M. Beran, Collection Czech. Chem. Commun., 28, 1603 (1963). In German.
169. T. V. Healy, Nucl. Sci. Eng., 16, 413 (1963). (Also UKAEA, AERE-R-4191.)
170. T. V. Healy and H. A. C. McKay, Trans. Faraday Soc. 52, 633 (1956).
171. T. V. Healy and A. W. Gardner, J. Inorg. Nucl. Chem. 7, 245 (1958). (See also UKAEA, AERE-C/R-800.)
172. A. H. Heimbuch and H. Y. Gee, AEC New York Opns. Office, NYO-9138, 1962.
173. D. L. Heisig and T. E. Hicks, Lawrence Radiation Laboratory, Berkeley, Calif., UCRL-1169, 1952.
174. D. L. Heisig and T. E. Hicks, Lawrence Radiation Laboratory, Berkeley, Calif., UCRL-1664, Feb. 1952.
175. F. Helfferich, "Ion Exchange" (McGraw-Hill Book Co., Inc., New York, 1952).
176. A. Heller, R. Elson and Y. Marcus, Israel Atomic Energy Comm., Tel Aviv, IA-736.
177. E. Hesford, E. Jackson and H. A. C. McKay, J. Inorg. Nucl. Chem. 9, 279 (1959).
178. E. Hesford and H. A. C. McKay, Trans. Faraday Soc. 54, 573 (1958).
179. E. Hesford, H. A. C. McKay, and D. Scargill, J. Inorg. Nucl. Chem. 4, 321 (1957).
180. T. E. Hicks and H. W. Crandall, Lawrence Radiation Laboratory, Berkeley, Calif., UCRL-912, Sept. 1950.
181. C. E. Higgins, W. H. Baldwin, and J. M. Ruth, ORNL-1338, Aug. 1952.
182. O. F. Hill and F. J. Leitz, HW-21663, 1951.
183. O. F. Hill and F. J. Leitz, HW-23160, pp 24-5.
184. J. C. Hindman, A/CONF.15/1, Vol. 28, p 349, Paper/941.
185. D. C. Hoffman, LASL, LA 1721 (Rev), 1954, pp 271-279.

186. D. E. Horner and C. F. Coleman, ORNL-2830, Nov. 1959.
187. D. E. Horner and C. F. Coleman, ORNL-3051, March 1961.
188. G. R. Howells, T. G. Hughes, and K. Saddington, Progr. Nucl. Energy Ser. III, Vol. 3, Chap. 3-2, p 151. (See also A/CONF.15/1, Vol. 17, p 3, Paper/307.)
189. D. L. Hufford and B. F. Scott, in "The Transuranium Elements," p 1149, Paper/16.1.
190. A. Hultgren and E. Haeffner, A/CONF.15/1, Vol. 17, p 324, Paper/144.
191. G. J. Hunter and R. B. Chenley, UKAEA, AERE-AM-19, 1959.
192. E. K. Hyde, "The Nuclear Properties of the Heavy Elements. II. Detailed Radioactivity Properties" (Prentice Hall, Inc., New Jersey, 1964) pp 804-838.
193. C. H. Ice, HW-10277, June 1948.
194. M. G. Inghram, D. C. Hess, P. R. Fields, and G. L. Pyle, "Half-life of Pu^{240} as Determined by its U^{236} Daughter," briefly noted in ANL-4653.
195. E. R. Irish and W. H. Rease, HW-49483, April 1957.
196. H. Irving and D. N. Edgington, J. Inorg. Nucl. Chem. 15, 158 (1960).
197. H. Irving and D. N. Edgington, J. Inorg. Nucl. Chem. 20, 321 (1961).
198. H. Irving and D. N. Edgington, J. Inorg. Nucl. Chem. 20, 314 (1961).
199. See Ref. 197.
200. H. Irving and D. N. Edgington, J. Inorg. Nucl. Chem. 21, 169 (1961).
201. N. M. Isaac, P. R. Fields, and D. M. Gruen, J. Inorg. Nucl. Chem. 21, 152 (1960).
202. T. Ishimori, K. Watanabe, and T. Fujino, J. At. Energy Soc. Japan 3, 507 (1961).
203. T. Ishimori and J. Akatsu, Radiochim. Acta 1, 11 (1962).
204. N. Jackson and J. F. Short, UKAEA, AERE-M-444, July 1959.
205. W. R. Jacobsen, ANL-6637, 1962, pp33-42. Seventh Annual Meeting on Bio-assay and Analytical Chemistry, Oct. 12-13, 1961. Argonne National Laboratory. USAEC, 1962.
206. A. H. Jaffey, "The Actinide Elements," pp 596-732.
207. D. B. James and E. L. Christensen, LASL, LADC-5424, March 1963.
208. E. N. Jenkins and G. W. Sneddon, UKAEA, AERE-C-R-1399, Nov. 1954.
209. E. N. Jenkins and R. J. W. Streeton, UKAEA, AERE-R-3158, Dec. 1959.
210. W. J. Jenkins, J. Inorg. Nucl. Chem. 25, 463 (1963).
211. E. R. Jette, J. Chem. Phys. 23, 365 (1955).
212. N. R. Johnson, E. Eidiler, and G. D. O'Kelley, in "Inorganic Chemistry" (Interscience Pubs., New York, 1963) Vol. 2, Chap. VII.
213. N. R. Johnson, E. Eidiler, and G. D. O'Kelley, in "Inorganic Chemistry" (Interscience Pubs., New York, 1963) Vol 2, Chaps. III and VI.
214. M. M. Jones, HW-30384, Dec. 1953.
215. M. Kasha and G. E. Sheline, in "The Transuranium Elements," Paper/3.14.
216. R. E. Kartushova, T. I. Rudenko, and V. V. Fomin, Atomnaya Energ. 5, 24 (1958). In Russian. English trans. Soviet J. At. Energy 5, 831 (1958).

217. W. E. Keder, J. Inorg. Nucl. Chem. **24**, 561 (1962).
218. W. E. Keder, J. C. Ryan, and A. S. Wilson, J. Inorg. Nucl. Chem. **20**, 131 (1961).
219. W. E. Keder, J. C. Sheppard, and A. S. Wilson, J. Inorg. Nucl. Chem. **12**, 327 (1960).
220. D. M. Kemp, UKAEA, AERE-R-4119, July 1962.
221. J. Kennedy, UKAEA, AERE-M-1064, Aug. 1962.
222. J. Kennedy, R. V. Davies, and B. K. Robinson, UKAEA, AERE-C/R-1896, 1956.
223. J. Kennedy, J. W. Peckett, and R. Perkins, UKAEA, AERE-R-4516, 1964.
224. V. A. Khalkin, P. N. Palei, and A. A. Nemodruk, Radiokhimiya **5**, 215 (1963).
225. K. Kimura, Chem. Soc. Japan J. **33**, 1038 (1960).
226. K. Kimura, Chem. Soc. Japan J. **34**, 63 (1961).
227. E. L. King, ANL-JJK-14B-45, 1946. (See also Clinton Labs., Oak Ridge, Tenn. CN-2726, Dec. 1944).
228. E. L. King and W. H. Reas, J. Am. Chem. Soc. **73**, 1804 (1951).
229. P. Kirk and C. J. Rodden, "Transuranic Elements: Analytical Chemistry," Manhattan Dist; Oak Ridge, Tenn. 1947, AEC Report TID-5002; Nov. 1954.
230. J. Kleinberg, LASL, LA 1721 (Rev), 1954.
231. W. Knoch and R. Lindner, Z. Elektrochem. **64**, 1021 (1960). In German.
232. W. Knoch, Z. Naturforsch. **169**, 525 (1961).
233. R. Ko, HW-41025, Jan. 1956.
234. R. Ko, HW-79738, 1963.
235. R. J. Kofoed, Jr., HW-53368 (Supp. 1), 1963.
236. J. Kooi, JENER-Pub-11, 1956.
237. J. Kooi and U. Hollstein, Health Phys. **8**, 41 (Feb. 1962); U. Hollstein, A. H. M. Hoogma, and J. Kooi, Health Phys. **8**, 49 (1962).
238. V. N. Kosyakov, E. S. Gureyev, and G. N. Yakolev, "Separation of Transuranium Elements by Solution Extraction in Alkyl Phosphoric Acids," Paper given at Transplutonium Symposium, Argonne National Laboratory, Ill., May 1963. (Proceedings not published.)
239. K. A. Kraus, A/CONF.8/7, p 245, Paper/731.
240. K. A. Kraus and F. Nelson, A/CONF.8/7, p 113, Paper/837.
241. K. A. Kraus and F. Nelson, Ann. Rev. Nucl. Sci. **7**, 31 (1957).
242. K. A. Kraus, H. O. Phillips, T. A. Carlson, and J. S. Johnson, A/CONF.15/1, Vol. 28, p 3, Paper/1832.
243. I. K. Kressin and G. R. Waterbury, Analyt. Chem. **34**, 1598 (1962).
244. M. E. Krevinskaya et al., Radiokhimiya **1**, 545 (1959).
245. L. Kuča, Collection Czech. Chem. Commun. **27**, 2372 (Oct. 1962). In German.
246. L. Kuča, Jaderna Energie **8**, 286 (1962). In Czech.
247. V. I. Kuznetsov and T. G. Akimova, Radiokhimiya **2**, 357 (1960). [See also Soviet J. At. Energy **8**, 135 (1960).]
248. W. H. Langham, Manhattan Dist. Oak Ridge, Tenn. AEC Report MDDC-1555, 1947. (Also LAMS-603.)

249. R. P. Larsen and C. A. Seils, Jr., Anal. Chem. **32**, 1863 (1960).
250. W. M. Latimer, "The Oxidation States of the Elements and Their Potentials in Aqueous Solutions" (Prentice-Hall, New York, 1952).
251. S. Lawroski and M. Levinson, Progr. Nucl. Energy Ser. III, Vol. 2, Chap. 7-2, p 258.
252. T. S. Laxminarayanan, S. K. Patil, and H. D. Sharma, J. Inorg. Nucl. Chem. **26**, 1301 (1964).
253. Gordon Leader, ANL-WMM-125 (Date not available).
254. S. C. Leidt and S. M. Sanders, Jr., USAEC, Tech. Info. Serv., AECU-4414, July 1959.
255. R. D. Lingjaerde, JENER-48, 1957.
256. J. D. Ludwick, HW-64170, March 1960.
257. J. McClelland, LASL, LA 1858, 2nd Ed. 1958, Chap. 23.
258. H. A. C. McKay, A/CONF. 8/7, p 314, Paper/441. (See also Progr. Nucl. Energy Ser. III, Vol. 1, for an amended version.)
259. H. A. C. McKay and T. V. Healy, Progr. Nucl. Energy Ser. III, Vol. 2, Appendix III, p 546.
260. D. R. MacKenzie, AECL-1787, 1951.
261. W. J. Maeck, G. L. Booman, M. E. Kussy, and J. E. Rein, Anal. Chem. **32**, 1874 (1960).
262. W. J. Maeck, G. L. Booman, M. E. Kussy, and J. E. Rein, Anal. Chem. **33**, 1775 (1961).
263. C. J. Mandleberg, UKAEA, AERE-C/M-104, Feb. 1951.
264. C. J. Mandleberg and K. E. Francis, UKAEA, AERE-C/R-1088, Feb. 1953.
265. W. J. Maraman, A. J. Beaumont, and R. L. Nances, LASL, LA-1991, Jan. 1956.
266. Y. Marcus, Isarel Atomic Energy Comm., Tel Aviv, Pub/UP/R-20, 1960.
267. Y. Marcus, Chem. Rev. **63**, 139-170 (1963).
268. T. L. Markin and H. A. C. McKay, J. Inorg. Nucl. Chem. **7**, 298 (1958).
269. B. Martin and D. W. Ockenden, UKAEA, PG-165-W, 1960. [See also J. Inorg. Nucl. Chem. **21**, 96 (1961).]
270. G. W. Mason and D. F. Peppard, Nucl. Sci. Eng. **17**, 247 (Oct. 1963).
271. A. R. Matheson and I. M. Rehn, HW-13760, 1949.
272. E. Maxwell, R. Fryall, and W. H. Langham, AEC, Oak Ridge, Tenn., MDDC-1167, 1947.
273. E. Merz, Z. Anal. Chem. **166**, 417 (1959). In German.
274. C. F. Metz, Anal. Chem. **29**, 1748 (1957).
275. H. W. Miller and R. J. Brouns, Anal. Chem. **24**, 536 (1952). [See also HW-17266, (1950).]
276. H. W. Miller and R. J. Brouns, Anal. Chem. **24**, 536 (1952). [See also HW-17265, (1950).]
277. G. F. Mills and H. B. Whetsel, Carbide and Carbon Chemicals Co. K-25 Plant, Oak Ridge, Tenn., K-1064, Sept. 1953.
278. F. J. Miner, Dow Chem. Co. Rocky Flats Plant, Denver, Colo. RFP-357, Jan. 1964.

279. F. J. Miner, R. P. DeGrazio, and J. T. Byrne, Anal. Chem. **35**, 1218 (1963).
280. F. J. Miner, R. P. DeGrazio, R. P. Forrey, Jr., and T. C. Jones, Anal. Chim. Acta **22**, 214 (1960).
281. E. I. Moiseenko and A. M. Rozen, UKAEA, Deg-Inf-Ser-315-R. [Transl. from Radiokhimiya, No. 3, 274-80 (1960).]
282. F. L. Moore, Anal. Chem. **29**, 1660 (1957). [See also ORNL-1314, (1952).]
283. F. L. Moore, Anal. Chem. **30**, 908 (1958).
284. F. L. Moore, Anal. Chem. **30**, 1369 (1958).
285. F. L. Moore, Anal. Chem. **32**, 1075 (1960).
286. F. L. Moore, Nat'l Acad. of Sciences, Nuclear Science Series NAS-NS-3101, 1960.
287. F. L. Moore and J. E. Hudgens, Anal. Chem. **29**, 1767 (1957).
288. F. L. Moore and G. W. Smith, Nucleonics **13**, 66 (1955).
289. R. H. Moore, HW-SA-2804, March 1963.
290. R. H. Moore and W. L. Lyon, HW-59147, 1959.
291. K. Z. Morgan, in "Nuclear Instruments and Their Uses," Vol. 1, (John Wiley and Sons, New York, 1962) A. H. Snell, Ed. Chap. 7, p 391.
292. G. H. Morrison and H. Freiser, "Solvent Extraction in Analytical Chemistry" (John Wiley and Sons, Inc., New York, 1957).
293. R. J. Morrow, in "Radiochemical Procedures Used at Livermore," UCRL-14258, M. Linder, Ed. 1963.
294. A. I. Moskvina and V. P. Zaitseva, Radiokhimiya **4**, 73 (1961). In Russian.
295. M. N. Myers, HW-44987, Aug. 1956.
296. N. H. Nachtrieb, H. A. Patratz, O. R. Simi, S. Wexler, and B. S. Wildi, LASL, LA-387 (Del.), Sept. 1945.
297. D. Naumann, Joint Publications Research Service, New York, JPRS-11184, 1961. [Transl. from Z. Chem. **1**, 247 (1961).]
298. D. Naumann, Kernerergie **6**, 81 (1963). In German.
299. W. J. Neill and I. R. Higgins, ORNL-2592, Dec. 1958.
300. F. Nelson, T. Murase, and K. A. Kraus, J. Chromatog. **13**, 503 (1964).
301. T. W. Newton and F. B. Baker, LASL, LADC-5517, 1962.
302. T. W. Newton and S. W. Rabideau, J. Phys. Chem. **63**, 365 (1959).
303. J. M. Nielsen and T. M. Beasley, HW-SA-3337, 1963.
304. J. P. Nigon and R. A. Penneman, LASL, LA-1079 (Del.), March 1950.
305. D. W. Ockenden and G. A. Welch, J. Chem. Soc., 3358-63, Sept. 1956.
306. D. A. Orth, Ind. Eng. Chem., Process Design Develop. **2**, 121 (1963).
307. R. T. Overman and H. M. Clark, "Radioisotope Techniques" (McGraw-Hill Pub. Co., Inc., New York 1960). Chap. 5.
308. M. Pagès, J. Chim. Phys. **59**, 63 (1962). In French.
309. M. Pagès and M. Haissinsky, A/CONF. 15/1 Vol. 29, p 44, Paper/1156. (AEC-tr-3535.)
310. D. F. Peppard, J. R. Ferraro, and G. W. Mason, J. Inorg. Nucl. Chem. **7**, 231 (1958).

311. D. F. Peppard, G. W. Mason, and C. M. Andrejasich, J. Inorg. Nucl. Chem. 25, 1175 (1963).
312. D. F. Peppard, G. W. Mason, and S. McCarty, J. Inorg. Nucl. Chem. 13, 138 (1960).
313. D. F. Peppard, G. W. Mason, and R. J. Sironen, J. Inorg. Nucl. Chem. 10, 117 (1959).
314. D. F. Peppard, S. W. Moline, and G. W. Mason, J. Inorg. Nucl. Chem. 4, 344 (1957).
315. D. F. Peppard, M. H. Studier, M. V. Gergel, G. W. Mason, J. C. Sullivan, and J. F. Mech, AEC, Wash. D.C., AECD-3016, See also J. Am. Chem. Soc. 73, 2529 (1951).
316. R. W. Perkins, Private Communication, 1961.
317. W. C. Perkins, DP-874, Feb. 1964.
318. K. A. Petrov et al., Russ. J. Inorg. Chem. 5, 237 (1960). [Transl. from Zh. Neorg. Khim. 5, 498 (1960).]
319. G. Phillips and E. N. Jenkins, J. Inorg. Nucl. Chem. 4, 220 (1957).
320. N. I. Popov, V. I. Medvedovskii, and N. A. Bakh, Atomnaya Energ. 4, 154 (1958). (English transl. AEC-tr-3459.)
321. J. A. Porter, DP-388, July 1959.
322. J. A. Porter, DP-389, July 1959.
323. J. A. Porter, DP-621, Aug. 1961.
324. A. M. Poskanzer and B. M. Foreman, Jr., J. Inorg. Nucl. Chem. 16, 323 (1961).
325. I. Prevot, J. Coppel, and P. Regnaud, A/CONF. 15/1, Vol. 17, p 96, Paper/1171.
326. S. W. Rabideau, M. J. Bradley, and H. D. Cowan, LASL, LAMS-2236, June 1958.
327. R. H. Rainey, ORNL, CF-59-12-95, Dec. 1959.
328. M. J. Rasmussen and H. W. Crocker, HW-72285, Jan. 1962.
329. J. E. Rein, A. L. Langhorst, Jr., and M. C. Elliott, LASL, LA-2291, Feb. 1953.
330. Reference eliminated.
331. A. E. Reisenauer and J. L. Nelson, HW-59983, April 1959.
332. B. F. Rider, J. L. Russell, Jr., D. L. Harris, and S. P. Peterson, Jr., Gen. Electric Co. Vallecitos Atomic Lab., Pleasanton, Calif., GEAP-3373, March 1960.
333. F. P. Roberts and F. P. Brauer, HW-60552, June 1959.
334. A. M. Rozen and E. I. Moiseenko, Russ. J. Inorg. Chem. 4, (1959).
335. T. C. Runion and C. V. Ellison, ORNL-557, Jan. 1950.
336. E. R. Russell, DP-447, Feb. 1960.
337. J. L. Ryan, J. Phys. Chem. 64, 1375 (1960).
338. J. L. Ryan, AEC, Oak Ridge, Tenn. TID-7607, 1960, pp 2-20.

339. J. L. Ryan and E. J. Wheelwright, HW-55893 (Del), Feb. 1959.
340. J. L. Ryan and E. J. Wheelwright, A/CONF. 15/1, Vol. 17, p 137, Paper/1915.
341. J. Rydberg, Acta Chem. Scand. 9, 1252 (1955).
342. J. Rydberg, J. Inorg. Nucl. Chem. 5, 79 (1957).
343. J. Rydberg and B. Bernström, Acta Chem. Scand. 11, 86 (1957).
344. A. Samartseva, Soviet J. At. Energy 8, 279 (1960). [Transl. from Atomnaya Energiya, 9, 324 (1960).]
345. A. G. Samartseva, Radiokhimiya 4, 647 (1962). In Russian.
346. A. G. Samartseva, Radiokhimiya 5, 28 (1963). In Russian.
347. A. G. Samartseva, Radiokhimiya 4, 526 (1962). In Russian.
348. O. Samuelson, "Ion X Separations in Analytical Chemistry" (Almqvist and Wiksell, Stockholm, 1963).
349. S. M. Sanders, DP-146, 1956.
350. D. Scargill, K. Alcock, J. M. Fletcher, E. Hesford, and H. A. C. McKay, J. Inorg. Nucl. Chem. 4, 304 (1957).
351. J. Scheidhauer and L. Messainguiral, Chim. Anal. (Paris) 43, 462 (1961).
352. J. Scheidhauer, L. Messainguiral, and A. M. Meiraneisio, CEA-2354, 1953.
353. C. S. Schlea, M. R. Caverly, H. E. Henry, and W. R. Jenkins, DP-808, April 1963.
354. C. S. Schlea, M. R. Caverly, H. E. Henry, W. R. Jenkins, and W. C. Perkins, DP-739, Sept. 1962.
355. Reference deleted.
356. R. A. Schneider and K. M. Harmon, HW-53368, Feb. 1961.
357. R. A. Schneider, Anal. Chem. 34, 522 (1962). (Also HW-SA-2216.)
358. J. Schubert, Clinton Labs., Oak Ridge, Tenn., CN-1873, 1945.
359. K. Schwabe and D. Nebel, Z. Physik. Chem. 219-220, 339-54 (1962).
360. L. C. Schwendiman and J. W. Healy, Nucleonics 16, 78 (1958).
361. C. A. Seils, Jr., R. J. Meyer, and R. P. Larsen, Anal. Chem. 35, 1673 (1963). (Also AEC, Oak Ridge, Tenn., TID-18832.)
362. D. F. Shepard, HW-32710, 1955.
363. J. C. Sheppard, HW-51958, Aug. 1957.
364. V. B. Shevchenko and I. A. Federov, Radiochemistry (USSR) 2, 1 (1961). [Transl. from Radiokhimiya 2, 6 (1960).]
365. V. B. Shevchenko, N. S. Povitski, and A. S. Solovkin, Progr. Nucl. Energy Ser. III, Vol. 3, Chap. 3-6, p 217.
366. V. B. Shevchenko, V. S. Schmidt, and E. A. Mezhev, Russ. J. Inorg. Chem. 5, 929 (1960). [Transl. from Zh. Neorgan. Khim. 5, 1911 (1960).]
367. V. B. Shevchenko, I. V. Shilin, and Y. F. Zhdanov, Russ. J. Inorg. Chem. 5, 1367 (1960). [Transl. from Zh. Neorgan. Khim. 5, 2832 (1960).]
368. V. B. Shevchenko and V. S. Smelov, Soviet J. At. Energy 6, 76 (1960). [Transl. from Atomnaya Energiya 6, 140 (1959).]
369. V. B. Shevchenko, A. S. Solovkin, L. M. Kirillov, and A. I. Ivantsev, Radiochemistry (USSR) 3, 186 (1962). [Transl. from Radiokhimiya 3, 503 (1961).]

370. V. B. Shevchenko, A. S. Solovkin, L. M. Krilov, and A. I. Ivantsov, Radiochemistry (USSR) **3**, 186 (1962).
371. V. B. Shevchenko, A. S. Solovkin, I. V. Shilin, L. M. Kirilov, A. V. Rodionov, and V. V. Balandina, Radiochemistry (USSR) **2**, 77 (1961). [Transl. from Radiokhimiya **2**, 281 (1960).]
372. V. B. Shevchenko, V. G. Timoshev, and A. A. Volkova, J. Nucl. Energy, Part B: Reactor Technol. **1**, 211 (1960).
373. V. B. Shevchenko and Y. F. Zhdanov, Radiochemistry (USSR) **3**, 231 (1962). [Transl. from Radiokhimiya **3**, 676 (1961).]
374. W. H. Shipman and H. V. Weiss, USNRDL-TR-451, 1960.
375. T. H. Siddall III, DP-219, 1957.
376. T. H. Siddall III, J. Inorg. Nucl. Chem. **13**, 151 (1960).
377. T. H. Siddall III, J. Phys. Chem. **64**, 1863 (1960).
378. T. H. Siddall III, DP-541, Jan. 1961.
379. T. H. Siddall III, DP-548, Feb. 1961.
380. S. Siekierski, Polish Acad. of Sci., Inst. of Nucl. Research, Warsaw, NP-9695, Sept. 1960.
381. S. Siekierski and M. Taube, Nukleonika **6**, 489 (1961).
382. T. Sikkeland, JENER-38, 1955.
383. T. Sikkeland and J. Juul, JENER-44, Aug. 1956.
384. G. S. Sinitsyna, S. L. Faddeev, and G. M. Sukhodolov, Radiokhimiya **1**, 295 (1959). In Russian. (English transl. UCRL-Trans-1083 (L), Lawrence Radiation Laboratory, Livermore, Calif.)
385. A. L. Slade, DP-554, Feb. 1961.
386. H. Slätis, in "Beta and Gamma Ray Spectroscopy" (Interscience Pubs. Inc., New York, 1955). K. Siegbahn, Ed., Chap. VIII (II).
387. A. A. Smales, L. Airey, G. N. Walton, and R. O. R. Brooks, UKAEA, AERE-C/R-533, 1950.
388. L. L. Smith, DP-700, Dec. 1962.
389. L. K. Sokhina and A. D. Shelman, Zh. Neorgan. Khim. **5**, 1013 (1960). In Russian. French transl. CEA-TR/R-1515.
390. A. S. Solovkin, A. I. Ivantsov, and E. V. Renard, Russ. J. Inorg. Chem. **4**, 1307 (1959).
391. A. S. Solovkin, "Extraction of Electrolytes from Nitric Acid Solutions by Neutral Organophosphoric Solvents. Calculation of the Distribution Curves," USSR Soviet Ministrov. Glavnoe Upravlenie po Ispol' zovaniyu Atomnoi Energii, Moscow, 1960. (English transl. AEC-tr-4671.)
392. I. E. Starik, A. P. Ratner, M. A. Pasvik, and F. L. Ginzburg, Radiokhimiya **1**, 545 (1959). (English transl. NP-tr-741, UKAEA, Harwell, Berks, England.)
393. D. C. Stewart, Clinton Labs., Oak Ridge, Tenn. CN-3905, 1945 (Revised 1951).
394. D. C. Stewart and T. E. Hicks, Lawrence Radiation Laboratory, Berkeley, Calif. UCRL-861, Aug. 1950.
395. F. W. E. Strelow, Anal. Chem. **32**, 1185 (1960).
396. M. Taube, J. Inorg. Nucl. Chem. **12**, 174 (1959).

397. M. Taube, J. Inorg. Nucl. Chem. **15**, 171 (1960).
398. M. Taube, Nukleonika **5**, 531 (1960). In English.
399. M. Taube, Nukleonika **6**, 371 (1961). In English.
400. M. Taube, CEA-TR-R-1672, 1961.
401. S. G. Thompson and G. T. Seaborg, in Progr. Nucl. Energy Ser. III, Vol. 1, Chap. 5-1.
402. F. W. Tober and E. R. Russel, DP-349, Feb. 1959.
403. T. Y. Toribara, D. A. Morken, and C. Predmore, Rochester, N. Y. Univ. Atomic Energy Project, UR-607, Jan. 1962.
404. T. Y. Toribara, C. Predmore, and P. A. Hargrave, Rochester, N. Y. Univ. Atomic Energy Project, UR-606, Jan. 1962.
405. F. Trowell, UKAEA, AWRE-0-19/64, 1964.
406. D. G. Tuck, Anal. Chim. Acta **17**, 271 (1957).
407. D. G. Tuck, J. Inorg. Nucl. Chem. **6**, 252 (1958).
408. H. Umezawa, Nippon Genshiryoku Gakkaishi **2**, 478 (1960).
409. G. Valentini, L. Taglioni, and N. Mostin, Centre d'Etude de l'Energie Nucleaire, and Societe Belge pour l'Industrie Nucleaire, Brussels. EURAE-837, 1964.
410. H. H. Van Tuyl, HW-28530, 1953.
411. V. M. Vdovenko and M. P. Kovalskaya, A/CONF.15/1, Vol. 17, p 329, Paper/2216. (See also Progr. Nucl. Energy Ser. III, Vol. 3, p 221.)
412. V. M. Vdovenko, A. A. Lepovskii and S. A. Nikitovo, Radiochemistry (USSR) **3**, 143 (1962). [Transl. from Radiokhimiya **3**, 396 (1961).]
413. V. M. Vdovenko, A. A. Lepovskii, and S. A. Nikitovo, Radiochemistry (USSR) **2**, 44 (1960). [Transl. from Radiokhimiya **2**, 307 (1960).]
414. A. F. Voigt, A. Kant, N. R. Sleight, R. E. Hein, J. M. Wright, F. J. Walter, and H. D. Brown, in "The Transuranium Elements," p 162, Paper/3.8.
415. A. M. Vorobev and V. P. Kuzmina, Gigiena i Sanit., No. 9, 54 (Sept. 1963). In Russian.
416. R. Wagner, Process for the Reduction of Plutonium. (to Commissariat à l'Atomique Energie, Paris) Canadian Patent 626, 591, Aug. 29, 1961.
417. B. Warren, LASL, LA-1567, Sept. 10, 1954, Rev. Nov. 1955.
418. C. G. Warren, LASL, LA-1843 (Del), July 1953.
419. K. Watanabe, J. At. Energy Soc. Japan. **3**, 497 (1961).
420. B. Weaver and D. E. Horner, J. Chem. Eng. Data **5**, 260 (1960).
421. H. V. Weiss and W. H. Shipman, Anal. Chem. **33**, 37 (1961).
422. H. V. Weiss and W. H. Shipman, USNRDL-TR-541, Oct. 1961.
423. I. Walls, UKAEA, AERE-CE/M-19, Nov. 1950.
424. A. W. Wenzel and C. E. Pietri, Anal. Chem. **35**, 1324 (1963).
425. L. B. Werner and G. E. Moore, Clinton Labs., Oak Ridge, Tenn. CN-1630, 1944.
426. E. F. Westrum, Jr., in "The Transuranium Elements," p 1185, Paper/16.2.

427. J. C. White and W. J. Ross, National Academy of Sciences, Nuclear Science Series NAS-NS-3102, 1961.
428. V. J. Wilkinson and J. A. Peacegood, UKAEA, RDB-(W)/TN-77, June 1953.
429. A. S. Wilson, A/CONF.15/1, Vol. 17, p 341, Paper/544. (See also Progr. Nucl. Energy Ser. III, Vol. 3, Chap. 3-5, p 211.)
430. A. S. Wilson, HW-68207, 1961.
431. R. S. Winchester and W. J. Maraman, A/CONF.15/1, Vol. 17, p 168, Paper/530.
432. L. Wish, Anal. Chem. 31, 326 (1959).
433. L. Wish, USNRDL-TR-185, Oct. 1957.
434. L. Wish and M. Rowell, USNRDL-TR-117, Oct. 1956.
435. V. D. Zagrai and L. I. Sel'chenkov, Radiochemistry (USSR) 4, 161 (1962). [Transl. from Radiokhimiya 4, 181 (1962).]
436. Y. A. Zolotov and D. Nishanov, Radiochemistry (USSR) 4, 217 (1962). [Transl. from Radiokhimiya 4, 241, (1962).]
437. (No author), "Separations Processes, Progr. Report February-April 1951," KAPL-523, p. 17 Secret. (Quoted in DP-700, p 47, Ref. 28.)
438. (No author), "Chemistry Tech. Div. Quarterly Progress Report for Period Ending August 20, 1951," ORNL 1141, 1952, Secret. (Quoted in DP-700, p.47, Ref. 20.)
439. A. H. Bushey, "Quarterly Progress Report - Chemistry Unit, January-March, 1953," HW-27727, 1953, Secret.
440. (No author), "Report of the Chemistry & Chemical Engineering Section for August-October 1953," KAPL-1002, 1953, p 42, Secret.
441. (No author), "Chemical Engineering Division Summary Report for January-March, 1954," ANL-5254, pp 11-15, Secret.
442. Reference deleted.
443. (No author), "ORNL Reactor Fuel Processing," 1960, Vol. 3, p 16.
444. (No author), "Nuclear Safety Guide," AEC Oak Ridge, Tenn. TID-7016, Rev. 1, 1961.
445. (No author), "Special Report No. 11," Centre d'Etude de l'Energie Nucleaire & Societe Belge pour l'Industrie Nucleaire, Brussels, 1962," EURAE-708.
446. (No author), UKAEA, PG-372-W, 1962.
447. (No author), "Procedures for Np and Pu," excerpt from Tracerlab Quarterly Progress Report, Richmond, Calif., Oct. 15, 1962.
448. (No author), "Semiannual Progress Report (On Chemistry) for the Period July through December 1960," New Brunswick Lab., AEC, New Jersey, NBL-170, Aug. 1961.
449. (No author), UKAEA, PG-309, 1962.
450. J. M. Fletcher, in "Aqueous Reprocessing Chemistry," Symposium at Brussels, Belgium, 1963, Eurochemic.

451. C. E. Holley, Jr., R. N. R. Mulford, E. J. Huber, Jr., E. L. Head, F. H. Ellinger, and C. W. Bjorklund, *A/CONF.* 15/1, Vol. 6, p 215, Paper 701.
452. R. F. Mitchell, *Anal. Chem.* 32, 326 (1960).
453. E. Wichers, W. G. Schlecht, and C. L. Gordon, *J. Research Nat'l. Bureau Std.* 33, 363, 451, 457 (1944).
454. H. Evans, private communication.
455. R. Ko, *Anal. Chem.* 28, 274 (1956).

MONOGRAPHS IN THE RADIOCHEMISTRY AND THE RADIOCHEMICAL TECHNIQUE SERIES

Copies of the following monographs are available from the
Clearinghouse for Federal Scientific and Technical Informa-
tion, National Bureau of Standards, U. S. Department of Com-
merce, Springfield, Va. 22151

- Aluminum and Gallium, NAS-NS-3032, \$0.50
Americium and Curium, NAS-NS-3006,
\$0.75
Antimony, NAS-NS-3033, \$0.50
Arsenic, NAS-NS-3002, (Rev.)1965 \$1.00
Astatine, NAS-NS-3012, \$0.50
Barium, Calcium, and Strontium, NAS-NS-
3010, \$1.25
Beryllium, NAS-NS-3013, \$0.75
Cadmium, NAS-NS-3001, \$0.75
Carbon, Nitrogen, and Oxygen, NAS-NS-
3019, \$0.50
Cesium, NAS-NS-3035, \$0.75
Chromium, NAS-NS-3007, (Rev.)1964 \$0.75
Cobalt, NAS-NS-3041, \$1.00
Copper, NAS-NS-3027, \$0.75
Fluorine, Chlorine, Bromine, and Iodine,
NAS-NS-3005, \$0.50
Francium, NAS-NS-3003, \$0.50
Germanium, NAS-NS-3043, \$0.50
Gold, NAS-NS-3036, \$0.50
Indium, NAS-NS-3014, \$0.50
Iridium, NAS-NS-3045, \$0.50
Iron, NAS-NS-3017, \$0.50
Lead, NAS-NS-3040, \$1.75
Magnesium, NAS-NS-3024, \$0.50
Manganese, NAS-NS-3018, \$0.50
Mercury, NAS-NS-3026, \$0.50
Molybdenum, NAS-NS-3009, \$0.50
Nickel, NAS-NS-3051, \$0.50
Niobium and Tantalum, NAS-NS-3039, \$0.75
Osmium, NAS-NS-3046, \$0.50
Palladium, NAS-NS-3052, \$0.75
Phosphorus, NAS-NS-3056, \$0.50
Platinum, NAS-NS-3044, \$0.50
Plutonium, NAS-NS-3058, \$2.00
Polonium, NAS-NS-3037, \$0.75
Potassium, NAS-NS-3048, \$0.50
Protactinium, NAS-NS-3016, \$1.00
Radium, NAS-NS-3057, \$2.25
Rare Earths—Scandium, Yttrium, and Ac-
tinium, NAS-NS-3020, \$3.00
Rare Gases, NAS-NS-3025, \$0.75
Rhenium, NAS-NS-3028, \$0.50
Rhodium, NAS-NS-3008, (Rev.)1965 \$1.00
Rubidium, NAS-NS-3053, \$0.50
Ruthenium, NAS-NS-3029, \$1.00
Selenium, NAS-NS-3030, (Rev.)1965 \$1.00
Silicon, NAS-NS-3049, \$0.50
Silver, NAS-NS-3047, \$0.75
Sodium, NAS-NS-3055, \$0.50
Sulfur, NAS-NS-3054, \$0.50
Technetium, NAS-NS-3021, \$0.50
Tellurium, NAS-NS-3038, \$0.50
Thorium, NAS-NS-3004, \$0.75
Tin, NAS-NS-3023, \$0.75
Titanium, NAS-NS-3034, \$0.50
Transcurium Elements, NAS-NS-3031,
\$0.50
Tungsten, NAS-NS-3042, \$0.50
Uranium, NAS-NS-3050, \$3.50
Vanadium, NAS-NS-3022, \$0.75
Zinc, NAS-NS-3015, \$0.75
Zirconium and Hafnium, NAS-NS-3011,
\$0.50
Activation Analysis with Charged Particles,
NAS-NS-3110, \$1.00
Applications of Computers to Nuclear and
Radiochemistry, NAS-NS-3107, \$2.50
Application of Distillation Techniques to
Radiochemical Separations, NAS-NS-
3108, \$0.50
Detection and Measurement of Nuclear Ra-
diation, NAS-NS-3105, \$1.50
Liquid-liquid Extraction with High-
molecular-weight Amines, NAS-NS-
3101, \$1.00
Low-level Radiochemical Separations, NAS-
NS-3103, \$0.50
Paper Chromatographic and Electromigra-
tion Techniques in Radiochemistry, NAS-
NS-3106, \$0.50
Processing of Counting Data, NAS-NS-
3109, \$1.75
Rapid Radiochemical Separations, NAS-NS-
3104, \$1.25
Separations by Solvent Extraction with Tri-
n-octylphosphine Oxide, NAS-NS-3102,
\$0.75