

# LOS ALAMOS EXPLOSIVES PERFORMANCE DATA

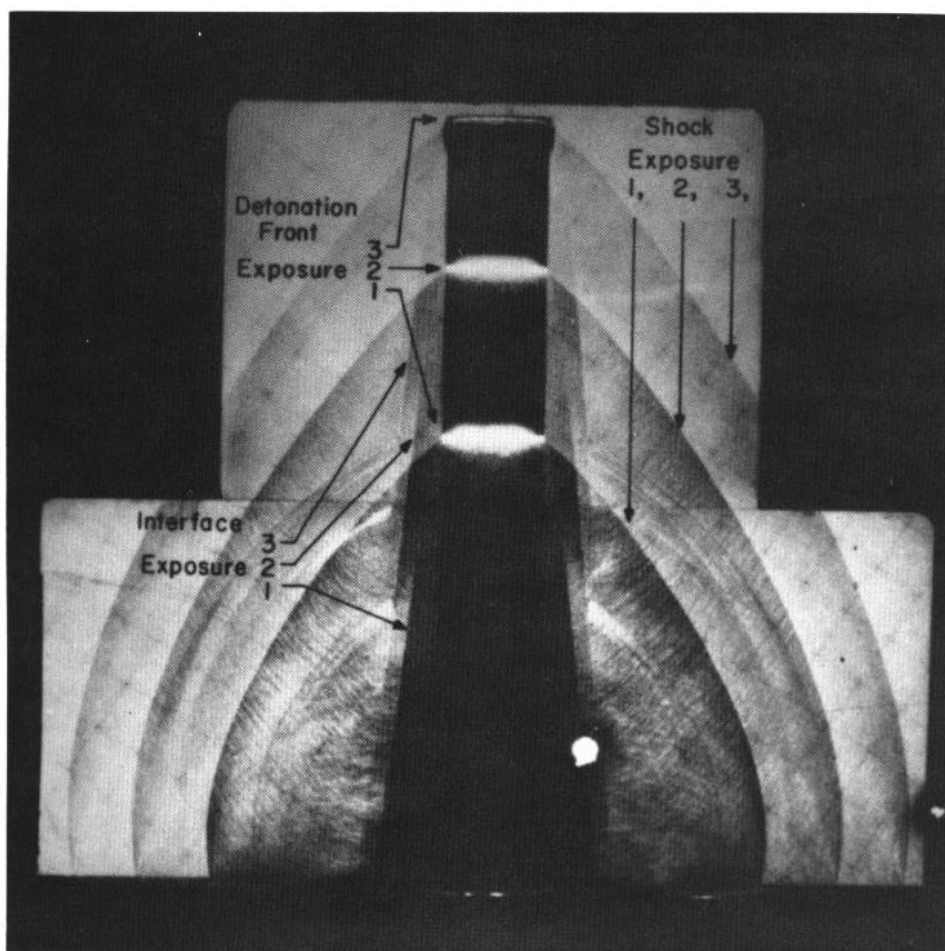

Shot C-4632. 10-cm-diam ANFO cylinder with Plexiglas confinement.

# LOS ALAMOS SERIES ON DYNAMIC MATERIAL PROPERTIES

LOS ALAMOS DATA CENTER  
FOR DYNAMIC MATERIAL PROPERTIES

## TECHNICAL COMMITTEE

Charles L. Mader	Program Manager
Stanley P. Marsh	Equation of State Editor
Terry R. Gibbs	Explosives Data Editor
Alphonse Popolato	Explosives Data Editor
Charles E. Morris	Shock Wave Profile Editor
Martha S. Hoyt	Computer Applications Analyst
Sharon L. Crane	Technical Editor

John F. Barnes  
Richard D. Dick  
John W. Hopson, Jr.  
James N. Johnson  
Elisabeth Marshall  
Timothy R. Neal  
Suzanne W. Peterson  
Raymond N. Rogers  
John W. Taylor  
Melvin T. Thieme  
Jerry D. Wackerle  
John M. Walsh



The following list of books have been published previously by the University of California Press at Berkeley for the Los Alamos Data Center for Dynamic Material Properties.

*LASL Shock Hugoniot Data*, Stanley P. Marsh, Editor. 1980.

*LASL PHERMEX Data, Volume I*, Charles L. Mader, Timothy R. Neal, and Richard D. Dick, Editors. 1980.

*LASL PHERMEX Data, Volume II*, Charles L. Mader, Editor. 1980.

*LASL PHERMEX Data, Volume III*, Charles L. Mader, Editor. 1980.

*LASL Explosive Property Data*, Terry R. Gibbs and Alphonse Popolato, Editors. 1980.

*Los Alamos Shock Wave Profile Data*, Charles E. Morris, Editor. 1981.

# **LOS ALAMOS EXPLOSIVES PERFORMANCE DATA**

**Editors — Charles L. Mader  
James N. Johnson  
Sharon L. Crane**

**UNIVERSITY OF CALIFORNIA PRESS**  
Berkeley • Los Angeles • London



University of California Press  
Berkeley and Los Angeles, California

University of California Press, Ltd.  
London, England

Copyright © 1982 by  
The Regents of the University of California

ISBN 0-520-04014-7

Series ISBN 0-520-04007-4

Library of Congress Catalog Card Number: 82-40391

Printed in the United States of America

1 2 3 4 5 6 7 8 9

# CONTENTS

PREFACE . . . . .	ix
PART I. PLATE ACCELERATION DATA . . . . .	1
PART II. AQUARIUM DATA . . . . .	23
PART III. DETONATION VELOCITY DATA . . . . .	257



# PREFACE

This volume of the Los Alamos Series on Dynamic Material Properties is designed to provide a source of reliable performance data on some of the high explosives that have been studied at the Los Alamos National Laboratory. It is a companion volume to the *LASL Explosive Property Data* volume edited by Terry R. Gibbs and Alphonse Popolato and published by the University of California Press in 1980. That volume covered only pure explosives and explosive formulations that were well characterized. In this volume, explosives performance, as measured by plate acceleration data, aquarium data, and detonation velocity data, is presented for many explosives and geometries that interest explosives scientists more than they interest explosives engineers. It also includes data for conventional explosives that were not presented in the Gibbs and Popolato volume.

The editors gratefully acknowledge the assistance of many staff members who contributed to the data collection for this volume. They also acknowledge the phototype-setting section of Los Alamos National Laboratory's Technical Information Group for their invaluable help in this series of books, and especially, Alice Creek.



# PART I

## PLATE ACCELERATION DATA

The most commonly used values for detonation pressure are from experiments in which the pressure has been inferred from its measured effects in other materials. The initial free-surface velocity of a plate may be determined by many techniques. Among these are the protected flash gap technique used by Deal<sup>1</sup> and described in *LASL Explosive Property Data*,<sup>2</sup> the reflected wire technique used by Craig,<sup>3</sup> and the reflection change-flash gap technique used by Davis.<sup>4</sup> These three techniques were used to measure the plate free-surface velocities presented in this section.

The data presented include many explosives and geometries of more interest to the detonation theorist than to the explosives engineer. The detonation pressure is a function of the charge length, the charge diameter, the confinement, and the booster. The interrelationships of these effects are yet to be determined so these data are presented for use by those interested in studying these effects. The "effective" Chapman-Jouguet pressure is given where the experimentalist used a linear least squares fit of the free-surface velocity versus plate thickness and the acoustic approximation to estimate the detonation pressure at zero plate thickness. This has been defined as the "effective C-J pressure" in Ref. 5, but its theoretical significance is yet to be determined.

The data presented were generated by Bobby G. Craig, William C. Davis, John B. Ramsay, and Wray Garn. The data generated by William E. Deal were described in Ref. 2.

### REFERENCES

1. W. E. Deal, *Journal of Chemical Physics* **27**, 796-800 (1957).
2. Terry R. Gibbs and Alphonse Popolato, Editors, *LASL Explosive Property Data* (University of California Press, Berkeley, 1980).
3. W. C. Davis and B. G. Craig, *Review of Scientific Instruments* **32**, 579-581 (1961).
4. W. C. Davis and Douglas Venable, "Pressure Measurements for Composition B-3," *Fifth Symposium (International) on Detonation, Pasadena, California, August 18-21, 1970*, Office of Naval Research symposium report ACR-184 (1970), pp. 13-21.
5. Charles L. Mader, *Numerical Modeling of Detonations* (University of California Press, Berkeley, 1979).

PLATE ACCELERATION DATA

**Data List**

Acenina-15 at 1.139 g/cm <sup>3</sup> . . . . .	3
Comp A-3 at 1.632 g/cm <sup>3</sup> . . . . .	3
Comp B-3 at 1.730 g/cm <sup>3</sup> . . . . .	4
Cyclotol at 1.754 g/cm <sup>3</sup> . . . . .	5
DATB at 1.782 g/cm <sup>3</sup> . . . . .	5
EDB/TNM at 1.40 g/cm <sup>3</sup> . . . . .	6
EDB/TNM at 1.427 g/cm <sup>3</sup> . . . . .	6
HDB/TNM at 1.40 g/cm <sup>3</sup> . . . . .	6
Nimea-5 at 1.245 g/cm <sup>3</sup> . . . . .	6
Nimea-25 at 1.183 g/cm <sup>3</sup> . . . . .	6
Nitromethane at 1.128 g/cm <sup>3</sup> . . . . .	7
NM/TNM at 1.197 g/cm <sup>3</sup> . . . . .	8
NM/TNM at 1.310 g/cm <sup>3</sup> . . . . .	8
NM/TNM at 1.397 g/cm <sup>3</sup> . . . . .	8
PBX 9010 at 1.784 g/cm <sup>3</sup> . . . . .	9
PBX 9404 at 0.969 g/cm <sup>3</sup> . . . . .	9
PBX 9404 at 1.844 g/cm <sup>3</sup> . . . . .	9
PBX 9404-03 at 1.844 g/cm <sup>3</sup> . . . . .	10
PBX 9404-05 at 1.832 g/cm <sup>3</sup> . . . . .	11
PBX 9502 at 1.889 g/cm <sup>3</sup> . . . . .	13
PETN at 1.648 g/cm <sup>3</sup> . . . . .	14
PETN at 1.670 g/cm <sup>3</sup> . . . . .	14
TATB at 1.876 g/cm <sup>3</sup> . . . . .	15
TNT at 0.733 g/cm <sup>3</sup> . . . . .	15
TNT at 1.051 g/cm <sup>3</sup> . . . . .	15
TNT at 1.631 g/cm <sup>3</sup> . . . . .	16
TNT at 1.633 g/cm <sup>3</sup> . . . . .	16
TNT at 1.639 g/cm <sup>3</sup> . . . . .	17
TNT (liquid) at 1.455 g/cm <sup>3</sup> . . . . .	17
Toluene/NM at 1.088 g/cm <sup>3</sup> . . . . .	18
X-0007 at 1.738 g/cm <sup>3</sup> . . . . .	18
X-0008 at 1.767 g/cm <sup>3</sup> . . . . .	18
X-0009 at 1.80 g/cm <sup>3</sup> . . . . .	19
X-0118 at 1.711 g/cm <sup>3</sup> . . . . .	19
X-0143 at 1.797 g/cm <sup>3</sup> . . . . .	19
X-0183 at 1.811 g/cm <sup>3</sup> . . . . .	20
X-0191 at 1.824 g/cm <sup>3</sup> . . . . .	20
X-0192 at 1.854 g/cm <sup>3</sup> . . . . .	20
X-0204 at 1.908 g/cm <sup>3</sup> . . . . .	21
X-0219 at 1.91 g/cm <sup>3</sup> . . . . .	21

Shot No.	Explosive	Density (g/cm <sup>3</sup> )	Charge Length (mm)	Charge Diameter (mm)	Booster	Plate Material	Plate Thickness (mm)	Free-Surface Velocity (mm/μs)	Effective C J Pressure (GPa)
B-5117	Acenina-15 <sup>a</sup>	1.139	457	38.1	b	Dural	0.80	1.53	
B-5119	Acenina-15 <sup>a</sup>	1.139	457	38.1	b	Dural	4.52	1.46	
B-5120	Acenina-15 <sup>a</sup>	1.139	457	38.1	b	Dural	1.52	1.47	
B-5365	Acenina-15 <sup>a</sup>	1.139	457	38.1	b	Dural	0.34	1.56	
B-5377	Acenina-15 <sup>a</sup>	1.139	457	19.0	b	Dural	2.47	1.47	
B-5040	Acenina-15 <sup>c</sup>	1.139	457	41.3	b	Dural	1.90	1.49	
B-5042	Acenina-15 <sup>c</sup>	1.139	457	41.3	b	Dural	4.45	1.44	
B-5043	Acenina-15 <sup>c</sup>	1.139	457	41.3	b	Dural	0.79	1.52	
B-5051	Acenina-15 <sup>c</sup>	1.139	457	41.3	b	Dural	0.61	1.53	

<sup>a</sup>One mole of acetonitrile to 1 mole of HNO<sub>3</sub> and 14.75 wt% H<sub>2</sub>O, confined in 6.35-mm-thick steel tubes.

<sup>b</sup>P-022 lens and 25.4-mm Comp B.

<sup>c</sup>Confined by glass tubes, with detonation velocity of 5800 m/s.

E-1583	Comp A-3 <sup>a</sup>	1.631	304.8	25.4	b	Dural	2.819	2.759	28.7
E-1584	Comp A-3 <sup>a</sup>	1.631	304.8	25.4	b	Dural	1.768	2.856	
E-1585	Comp A-3 <sup>a</sup>	1.632	609.6	50.8	b	Dural	2.819	2.851	
E-1586	Comp A-3 <sup>a</sup>	1.631	609.6	50.8	b	Dural	1.760	2.938	

<sup>a</sup>90 wt% RDX/10 wt% wax with detonation velocity of 8369 m/s.

<sup>b</sup>SE 1 detonator and a 12.7-mm tetryl pellet.

PLATE ACCELERATION DATA



Shot No.	Explosive	Density (g/cm <sup>3</sup> )	Charge Length (mm)	Charge Diameter (mm)	Booster	Plate Material	Plate Thickness (mm)	Free-Surface Velocity (mm/μs)	Effective C-J Pressure (GPa)
E-1428	Comp B-3	1.730	152.4	50.8	P-022 lens	Dural	5.367	3.054	29.0
E-1429	Comp B-3	1.728	152.4	50.8	P-022 lens	Dural	3.840	3.162	
E-1430	Comp B-3	1.730	152.4	50.8	P-022 lens	Dural	2.451	3.267	
E-1431	Comp B-3	1.731	152.4	50.8	P-022 lens	Dural	1.303	3.324	
E-1432	Comp B-3	1.730	152.4	50.8	P-022 lens	Dural	0.912	3.450	
E-1433	Comp B-3	1.730	152.4	50.8	P-022 lens	Dural	0.749	3.597	
E-1434	Comp B-3	1.729	152.4	50.8	P-022 lens	Dural	0.536	3.744	
B-7249	Comp B-3	1.730	12.69	203.2	P-081 lens	Dural	6.088	3.01	
B-7251	Comp B-3	1.730	12.69	203.2	P-081 lens	Dural	6.086	2.92	
B-7246	Comp B-3	1.730	12.71	203.2	P-081 lens	Dural	1.537	3.36	
B-7214	Comp B-3	1.730	12.69	203.2	P-081 lens	Dural	1.524	3.06	
B-7303	Comp B-3	1.730	12.70	203.2	P-081 lens	Dural	1.524	3.38	
B-7304	Comp B-3	1.730	25.38	203.2	P-081 lens	Dural	6.353	3.15	
B-7213	Comp B-3	1.730	25.39	203.2	P-081 lens	Dural	1.527	3.25	
B-7247	Comp B-3	1.730	50.77	203.2	P-081 lens	Dural	24.38	2.90	
B-7316	Comp B-3	1.730	50.76	203.2	P-081 lens	Dural	6.360	3.28	
C-3679	Comp B-3	1.730	50.80	203.2	P-081 lens	Dural	1.524	3.44	
B-7282	Comp B-3	1.730	101.6 cube		P-081 lens	Dural	12.22	3.36	
B-7281	Comp B-3	1.730	101.6 cube		P-081 lens	Dural	8.153	3.42	
B-7280	Comp B-3	1.730	101.6 cube		P-081 lens	Dural	4.059	3.55	
B-7252	Comp B-3	1.730	101.6 cube		P-081 lens	Dural	2.032	3.52	

PLATE ACCELERATION DATA

B-7314	Comp B-3	1.730	126.9	203.2	P-081 lens	Dural	6.353	3.55	
C-3707	Comp B-3	1.730	127.0	203.2	P-081 lens	Dural	1.532	3.64	
B-7315	Comp B-3	1.730	203.2	203.2	P-081 lens	Dural	6.350	3.59	
C-3685	Comp B-3	1.730	203.2	203.2	P-081 lens	Dural	1.521	3.70	
E-3323	Comp B-3	1.730	12.69	101.6	P-040 lens	Dural	5.098	2.79	
E-3320	Comp B-3	1.730	12.69	101.6	P-040 lens	Dural	2.565	2.94	
E-3322	Comp B-3	1.730	25.40	101.6	P-040 lens	Dural	10.150	2.86	
E-3317	Comp B-3	1.730	25.39	101.6	P-040 lens	Dural	5.100	3.01	
E-3321	Comp B-3	1.730	25.41	101.6	P-040 lens	Dural	2.560	3.19	
E-3328	Comp B 3	1.730	50.79	101.6	P-040 lens	Dural	20.33	2.94	
E-3327	Comp B-3	1.730	50.80	101.6	P-040 lens	Dural	10.18	3.15	
E-3324	Comp B-3	1.730	50.79	101.6	P-040 lens	Dural	2.542	3.30	
E-1524	Cyclotol <sup>a</sup>	1.754	508	50.8	<sup>b</sup>	Dural	1.016	3.594	32.0
E-1525	Cyclotol <sup>a</sup>	1.754	508	50.8	<sup>b</sup>	Dural	2.073	3.380	
E-1526	Cyclotol <sup>a</sup>	1.754	254	25.4	<sup>b</sup>	Dural	1.016	3.471	
E-1527	Cyclotol <sup>a</sup>	1.754	254	25.4	<sup>b</sup>	Dural	2.068	3.265	

<sup>a</sup>77.08 wt% RDX/22.92 wt% TNT with a detonation velocity of 8292 m/s.

<sup>b</sup>SE-1 detonator and a tetryl pellet with unconfined charges.

E-868	DATB <sup>a</sup>	1.782	304.8	25.4	<sup>b</sup>	Dural	3.0	2.626	25.9
E-872	DATB <sup>a</sup>	1.782	304.8	25.4	<sup>b</sup>	Dural	3.0	2.648	
B-4473	DATB <sup>a</sup>	1.782	304.8	50.8	<sup>c</sup>	Dural	3.0	3.031	
B-4471	DATB <sup>a</sup>	1.782	152.4	12.7	<sup>d</sup>	Dural	2.96	2.425	
B-4472	DATB <sup>a</sup>	1.782	152.4	12.7	<sup>d</sup>	Dural	2.96	2.306	

<sup>a</sup>DATB was encased in 5.0-mm-thick brass tubes with a detonation velocity of 7518 m/s.

<sup>b</sup>1E15 detonator and 101.6-mm TNT.

<sup>c</sup>1E15 detonator and 304.8-mm TNT.

<sup>d</sup>1E15 detonator and 152.4-mm TNT.

PLATE ACCELERATION DATA

Shot No.	Explosive	Density (g/cm <sup>3</sup> )	Charge Length (mm)	Charge Diameter (mm)	Booster	Plate Material	Plate Thickness (mm)	Free-Surface Velocity (mm/μs)	Effective C-J Pressure (GPa)
8A-1755	EDB/TNM <sup>a</sup>	1.40	50.8	57.15	<sup>b</sup>	Dural	2.54	2.40	17.2
8A-1751	EDB/TNM <sup>c</sup>	1.427	50.8	57.15	<sup>b</sup>	Dural	2.54	2.295	16.7
8A-1880	HDB/TNM <sup>d</sup>	1.40	25.4	57.15	<sup>b</sup>	Dural	2.54	2.40 (overdriven)	
8A-1897	HDB/TNM <sup>d</sup>	1.40	50.8	57.15	<sup>b</sup>	Dural	2.54	2.20	15.7
8A-1925	HDB/TNM <sup>d</sup>	1.40	76.2	57.15	<sup>b</sup>	Dural	2.54	2.21	
8A-1877	HDB/TNM <sup>d</sup>	1.40	50.8	57.15	<sup>b</sup>	Dural	2.54	2.14	
8A-1878	HDB/TNM <sup>d</sup>	1.40	50.8	57.15	<sup>b</sup>	Dural	5.08	2.29	
8A-1879	HDB/TNM <sup>d</sup>	1.40	50.8	57.15	<sup>b</sup>	Dural	10.16	2.08	

<sup>a</sup>One mole of ethyl decaborane to 3.75 moles tetranitromethane with a detonation velocity of 6740 m/s.

<sup>b</sup>P-016 lens and 50-mm Comp B.

<sup>c</sup>One mole of ethyl decaborane to 4.75 moles tetranitromethane with a detonation velocity of 6820 m/s.

<sup>d</sup>One mole of Hi-Cal-3 to 4.3 moles tetranitromethane with a detonation velocity of 6700 m/s.

E-1189	Nimeca-5 <sup>a</sup>	1.245	457	41.3	<sup>b</sup>	Dural	0.30	2.06	
E-1192	Nimeca-5 <sup>a</sup>	1.245	457	41.3	<sup>b</sup>	Dural	0.76	2.05	
E-1193	Nimeca-5 <sup>a</sup>	1.245	457	41.3	<sup>b</sup>	Dural	4.29	1.91	
E-1196	Nimeca-5 <sup>a</sup>	1.245	457	41.3	<sup>b</sup>	Dural	2.30	2.01	
E-1198	Nimeca-5 <sup>a</sup>	1.245	457	41.3	<sup>b</sup>	Dural	0.62	2.00	
B-5032	Nimeca-25 <sup>c</sup>	1.183	457	41.3	<sup>b</sup>	Dural	3.73	1.76	
B-5033	Nimeca-25 <sup>c</sup>	1.183	457	41.3	<sup>b</sup>	Dural	1.29	1.90	
B-5034	Nimeca-25 <sup>c</sup>	1.183	457	41.3	<sup>b</sup>	Dural	0.77	1.90	
B-5053	Nimeca-25 <sup>c</sup>	1.183	457	41.3	<sup>b</sup>	Dural	0.36	1.93	

<sup>a</sup>One mole of nitromethane to 1 mole of HNO<sub>3</sub> and 4.7 wt% H<sub>2</sub>O with a detonation velocity of 6570 m/s.

<sup>b</sup>P-022 lens and 25.4-mm Comp B.

<sup>c</sup>One mole of nitromethane to 1 mole of HNO<sub>3</sub> and 25 wt% H<sub>2</sub>O with a detonation velocity of 6250 m/s.

E 1036	Nitromethane <sup>a</sup>	1.128	609.6	38.1	b	2024 T-4 Dural	4.839	1.747
E-1061	Nitromethane <sup>a</sup>	1.128	609.6	38.1	b	2024 T-4 Dural	4.851	1.760
E-1049	Nitromethane <sup>a</sup>	1.128	609.6	38.1	b	2024 T-4 Dural	3.691	1.763
E-1057	Nitromethane <sup>a</sup>	1.128	609.6	38.1	b	2024 T-4 Dural	3.700	1.795
E 1058	Nitromethane <sup>a</sup>	1.128	609.6	38.1	b	2024 T-4 Dural	2.324	1.809
E-1062	Nitromethane <sup>a</sup>	1.128	609.6	38.1	b	2024 T-4 Dural	1.397	1.903
E-1052	Nitromethane <sup>a</sup>	1.128	609.6	38.1	b	2024 T-4 Dural	1.148	1.930
E-1053	Nitromethane <sup>a</sup>	1.128	609.6	38.1	b	2024 T-4 Dural	1.158	1.939
E-1050	Nitromethane <sup>a</sup>	1.128	609.6	38.1	b	2024 T-4 Dural	0.554	2.044
E-1054	Nitromethane <sup>a</sup>	1.128	609.6	38.1	b	2024 T-4 Dural	0.551	2.063
E-1055	Nitromethane <sup>a</sup>	1.128	609.6	38.1	b	2024 T-4 Dural	0.559	2.066
E-1135	Nitromethane <sup>a</sup>	1.128	609.6	38.1	b	Sierracin	5.077	3.356
E-1136	Nitromethane <sup>a</sup>	1.128	609.6	38.1	b	Sierracin	5.083	3.327
E-1093	Nitromethane <sup>a</sup>	1.128	609.6	38.1	b	Sierracin	3.150	3.346
E 1095	Nitromethane <sup>a</sup>	1.128	609.6	38.1	b	Sierracin	3.150	3.371
E-1096	Nitromethane <sup>a</sup>	1.128	609.6	38.1	b	Sierracin	1.547	3.454
E-1092	Nitromethane <sup>a</sup>	1.128	609.6	38.1	b	Sierracin	1.468	3.521
E-1068	Nitromethane <sup>a</sup>	1.128	609.6	38.1	b	Sierracin	0.409	3.750
E-1084	Nitromethane <sup>a</sup>	1.128	609.6	38.1	b	Sierracin	0.356	3.694

<sup>a</sup>Confined by a 3.17-mm-thick brass tube.

<sup>b</sup>P-040 lens, 25.4-mm Baratol, 2.77-mm steel, and 15.4-mm Sierracin 611.

PLATE ACCELERATION DATA

Shot No.	Explosive	Density (g/cm <sup>3</sup> )	Charge Length (mm)	Charge Diameter (mm)	Booster	Plate Material	Plate Thickness (mm)	Free-Surface Velocity (mm/μs)	Effective C-J Pressure (GPa)
E-2089	Nitromethane	1.128	25.4	101.6	<sup>a</sup>	Dural	0.635	1.945	
E-2090	Nitromethane	1.128	25.4	101.6	<sup>a</sup>	Dural	1.280	1.818	
	Nitromethane	1.128	50.8	203.2	<sup>b</sup>	Dural	0.803	2.005	
	Nitromethane	1.128	50.8	203.2	<sup>b</sup>	Dural	1.280	1.928	
	Nitromethane	1.128	50.8	203.2	<sup>b</sup>	Dural	1.280	1.918	
	Nitromethane	1.128	50.8	203.2	<sup>b</sup>	Dural	2.555	1.780	
E-2092	Nitromethane	1.128	101.6	304.8	<sup>c</sup>	Dural	0.63	2.035	
E-2093	Nitromethane	1.128	101.6	304.8	<sup>c</sup>	Dural	2.540	1.913	
E-2093	Nitromethane	1.128	101.6	304.8	<sup>c</sup>	Dural	2.540	1.895	
E-2094	Nitromethane	1.128	101.6	304.8	<sup>c</sup>	Dural	5.080	1.723	
8A-1971	NM/TNM <sup>a</sup>	1.197	50.8	57.15	<sup>b</sup>	Dural	6.35	2.042	13.8
8A-1972	NM/TNM <sup>c</sup>	1.310	50.8	57.15	<sup>b</sup>	Dural	6.35	2.277	15.6
8A-2228	NM/TNM <sup>d</sup>	1.397	50.8	57.15	<sup>b</sup>	Dural	6.35	2.39	16.8

<sup>a</sup>P-040 lens, 12.7-mm TNT, and 0.1524-mm Mylar.

<sup>b</sup>P-081 lens, 12.7-mm TNT, and 0.1524-mm Mylar.

<sup>c</sup>P-120 lens, 25.4-mm TNT, and 0.1524-mm Mylar.

<sup>a</sup>One mole of nitromethane to 0.071 mole tetranitromethane with a detonation velocity of 6570 m/s.

<sup>b</sup>P-022 lens and 50-mm Comp B.

<sup>c</sup>One mole of nitromethane to 0.25 mole tetranitromethane with a detonation velocity of 6880 m/s.

<sup>d</sup>One mole of nitromethane to 0.50 mole tetranitromethane with a detonation velocity of 6780 m/s.

E-1492	PBX 9010	1.784	508	50.8	<sup>a</sup>	Dural	1.308	3.375	32.8
E-1493	PBX 9010	1.784	508	50.8	<sup>a</sup>	Dural	2.068	3.276	
E-1494	PBX 9010	1.781	254	25.4	<sup>a</sup>	Dural	2.070	3.005	

<sup>a</sup>SE-1 detonator and 6.35-mm tetryl pellets.

E-2154	PBX 9404 <sup>a</sup>	0.969	101.6	300	<sup>b</sup>	Plexiglas	6.35	3.183	9.18
E-2155	PBX 9404 <sup>a</sup>	0.969	101.6	300	<sup>b</sup>	Plexiglas	24.05	3.119	

<sup>a</sup>Detonation velocity is 5905 m/s.

<sup>b</sup>P-120 lens and 25.4 mm TNT.

E-2128	PBX 9404	1.844	12.7	101.6	P-040 lens	2024 ST Dural	3.23	3.12	30.3
E-2127	PBX 9404	1.844	12.7	101.6	P-040 lens	2024 ST Dural	4.44	3.03	
E-2032	PBX 9404	1.844	12.7	101.6	P-040 lens	2024 ST Dural	6.36	2.92	
E-2033	PBX 9404	1.844	12.7	101.6	P-040 lens	2024 ST Dural	12.71	2.57	
E-2033	PBX 9404	1.844	12.7	304.8	P-120 lens	2024 ST Dural	3.27	3.20	31.2
E-2345	PBX 9404	1.844	12.7	304.8	P-120 lens	2024 ST Dural	4.55	3.1	
E-2368	PBX 9404	1.844	12.7	101.6	P-040 lens	Magnesium	3.34	4.18	30.6
E-2361	PBX 9404	1.844	12.7	101.6	P-040 lens	Magnesium	3.72	4.14	
E-2228	PBX 9404	1.844	12.7	101.6	P-040 lens	Magnesium	5.00	4.10	
E-2230	PBX 9404	1.844	12.7	101.6	P-040 lens	Magnesium	7.83	3.95	
	PBX 9404	1.844	25.4	203.2	P-080 lens	2024 ST Dural	2.20	3.45	33.5
	PBX 9404	1.844	25.4	203.2	P-080 lens	2024 ST Dural	2.50	3.45	
	PBX 9404	1.844	25.4	203.2	P-080 lens	2024 ST Dural	4.50	3.39	
E-2034	PBX 9404	1.844	25.4	203.2	P-080 lens	2024 ST Dural	6.35	3.33	
E-2037	PBX 9404	1.844	25.4	203.2	P-080 lens	2024 ST Dural	12.70	3.075	

PLATE ACCELERATION DATA

Shot No.	Explosive	Density (g/cm <sup>3</sup> )	Charge Length (mm)	Charge Diameter (mm)	Booster	Plate Material	Plate Thickness (mm)	Free-Surface Velocity (mm/μs)	Effective C-J Pressure (GPa)
F-2038	PBX 9404	1.844	25.4	203.2	P-080 lens	2024 ST Dural	25.40	2.675	
F-2775	PBX 9404	1.844	50.8	304.8	P-120 lens	2024 ST Dural	2.81	3.67	35.8
E-2776	PBX 9404	1.844	50.8	304.8	P-120 lens	2024 ST Dural	4.59	3.61	
E-2777	PBX 9404	1.844	50.8	304.8	P-120 lens	2024 ST Dural	12.17	3.47	
E-2778	PBX 9404	1.844	50.8	304.8	P-120 lens	2024 ST Dural	21.0	3.27	
E-2058	PBX 9404	1.844	101.6	304.8	P-120 lens	2024 ST Dural	3.13	3.90 <sup>a</sup>	37.5
E-2039	PBX 9404	1.844	101.6	304.8	P-120 lens	2024 ST Dural	25.4	3.45 <sup>a</sup>	
E-2044	PBX 9404	1.844	101.6	304.8	P-120 lens	2024 ST Dural	50.9	3.02 <sup>a</sup>	
F-2081	PBX 9404	1.844	101.6	304.8	P-120 lens	Plexiglas	6.0	6.06	37.2
E-2082	PBX 9404	1.844	101.6	304.8	P-120 lens	Plexiglas	12.0	5.65 <sup>a</sup>	
E-2083	PBX 9404	1.844	101.6	304.8	P-120 lens	Plexiglas	24.5	5.34 <sup>a</sup>	
E-2084	PBX 9404	1.844	101.6	304.8	P-120 lens	Plexiglas	51.0	4.66 <sup>a</sup>	

<sup>a</sup>Believed to be two dimensional.

E-1480	PBX 9404 03	1.844	76.2	25.4	P-022 lens	Dural	4.963	3.31	
E-1481	PBX 9404-03	1.844	76.2	25.4	P-022 lens	Dural	3.843	3.451	
E-1482	PBX 9404-03	1.844	76.2	25.4	P-022 lens	Dural	1.311	3.530	
E-1484	PBX 9404-03	1.844	76.2	25.4	P-022 lens	Dural	0.930	3.589	
E-1483	PBX 9404-03	1.844	76.2	25.4	P-022 lens	Dural	0.544	3.812	

E-1474	PBX 9404-03	1.836	152.4	50.8	P-022 lens	Dural	0.919	3.920	
E-1475	PBX 9404-03	1.838	152.4	50.8	P-022 lens	Dural	1.295	3.880	
E-1476	PBX 9404-03	1.837	152.4	50.8	P-022 lens	Dural	3.843	3.724	
E-1479	PBX 9404-03	1.837	152.4	50.8	P-022 lens	Dural	4.963	3.70	
E-1477	PBX 9404-03	1.837	152.4	50.8	P-022 lens	Dural	6.137	3.673	
E-1473	PBX 9404-03	1.838	152.4	50.8	P-022 lens	Dural	0.536	4.105	
E-1455	PBX 9404-03 <sup>a</sup>	1.837	508	50.8	<sup>b</sup>	Dural	1.295	3.685	37.6
E-1456	PBX 9404-03 <sup>a</sup>	1.837	508	50.8	<sup>b</sup>	Dural	2.063	3.545	
E-1457	PBX 9404-03 <sup>a</sup>	1.843	254	25.4	<sup>b</sup>	Dural	2.073	3.381	
E-1458	PBX 9404-03 <sup>a</sup>	1.843	254	25.4	<sup>b</sup>	Dural	1.295	3.467	

<sup>a</sup>Detonation velocity is 8806 m/s.

<sup>b</sup>SE 1 detonator and a 12.7 mm tetryl pellet with unconfined charges.

E-956	PBX 9404-05	1.832	69.85	69.85	P-022 lens	Dural	0.404	3.971	
E-957	PBX 9404-05	1.832	69.85	69.85	P-022 lens	Dural	1.958	3.558	
E-1247	PBX 9404-05	1.832	69.85	69.85	P-022 lens	Copper	0.302	2.439	
E-1248	PBX 9404-05	1.832	69.85	69.85	P-022 lens	Copper	0.305	2.435	
E-1252	PBX 9404-05	1.832	69.85	69.85	P-022 lens	Plexiglas	0.635	5.983	
E-1253	PBX 9404-05	1.832	69.85	69.85	P-022 lens	Plexiglas	0.622	6.183	
E-1259	PBX 9404-05	1.832	69.85	69.85	P-022 lens	Plexiglas	0.612	6.556	

PLATE ACCELERATION DATA



Shot No.	Explosive	Density (g/cm <sup>3</sup> )	Charge Length (mm)	Charge Diameter (mm)	Booster	Plate Material	Plate Thickness (mm)	Free-Surface Velocity (mm/μs)	Effective C-J Pressure (GPa)
E-1131	PBX 9404-05	1.833	209.5	69.85	"	Dural	4.826	3.883	
E-1098	PBX 9404-05	1.833	209.5	69.85	"	Dural	3.691	3.902	
E-1132	PBX 9404-05	1.833	209.5	69.85	"	Dural	2.311	3.954	
E-1133	PBX 9404-05	1.833	209.5	69.85	"	Dural	1.951	3.909	
E-1134	PBX 9404-05	1.833	209.5	69.85	"	Dural	1.146	3.968	
E-1154	PBX 9404-05	1.833	209.5	69.85	"	Dural	1.135	3.964	
E-1170	PBX 9404-05	1.833	209.5	69.85	"	Dural	0.541	4.036	
E-1153	PBX 9404-05	1.833	209.5	69.85	"	Dural	0.554	3.968	
E-959	PBX 9404-05	1.833	209.5	69.85	P-022 lens	Dural	0.429	4.317	
E-1097	PBX 9404-05	1.833	209.5	69.85	P-022 lens	Dural	0.572	3.928	
E-1130	PBX 9404-05	1.833	209.5	69.85	P-022 lens	Dural	0.556	3.996	
E-958	PBX 9404-05	1.833	209.5	69.85	P-022 lens	Dural	1.958	3.854	

\*P-040 lens, 25.4-mm Baratol, and 2.55-mm nickel.

E-1415	PBX 9404-05	1.833	209.5	69.85	"	Dural	4.610	3.278	
E-1416	PBX 9404-05	1.833	209.5	69.85	"	Dural	3.200	3.332	
E-1417	PBX 9404-05	1.833	209.5	69.85	"	Dural	2.819	3.365	
E-1418	PBX 9404-05	1.833	209.5	69.85	"	Dural	2.398	3.350	
E-1419	PBX 9404-05	1.833	209.5	69.85	"	Dural	2.073	3.392	
E-1420	PBX 9404-05	1.833	209.5	69.85	"	Dural	1.681	3.412	
E-1421	PBX 9404-05	1.833	209.5	69.85	"	Dural	1.303	3.434	
E-1423	PBX 9404-05	1.833	209.5	69.85	"	Dural	0.538	3.629	
E-1427	PBX 9404-05	1.833	209.5	69.85	"	Dural	0.536	3.790	
E-1426	PBX 9404-05	1.833	209.5	69.85	"	Dural	0.744	3.537	

E-1425	PBX 9404-05	1.833	209.5	69.85	<sup>a</sup>	Dural	0.833	3.694
E-1424	PBX 9404-05	1.833	209.5	69.85	<sup>a</sup>	Dural	0.917	3.461
E-1422	PBX 9404-05	1.833	209.5	69.85	<sup>a</sup>	Dural	0.917	3.547

<sup>a</sup>SE-1 detonator and a 6.35-mm tetryl pellet.

E-4829	PBX 9502	1.887	12.51	203.2	<sup>a</sup>	2024 ST Dural	3.20	2.999	28.5
E-4823	PBX 9502	1.889	12.48	203.2	<sup>a</sup>	2024 ST Dural	4.42	2.961	
E-4822	PBX 9502	1.889	12.48	203.2	<sup>a</sup>	2024 ST Dural	6.32	2.858	
E-4821	PBX 9502	1.888	12.48	203.2	<sup>a</sup>	2024 ST Dural	12.55	2.443	
E 4866	PBX 9502	1.888	25.00	203.2	<sup>a</sup>	2024 ST Dural	3.05	3.187	28.5
E-4832	PBX 9502	1.885	24.98	203.2	<sup>a</sup>	2024 ST Dural	3.19	3.123	
E-4831	PBX 9502	1.890	24.99	203.2	<sup>a</sup>	2024 ST Dural	6.31	2.935	
E-4830	PBX 9502	1.889	24.99	203.2	<sup>a</sup>	2024 ST Dural	12.55	2.790	
E-4865	PBX 9502	1.891	24.97	203.2	<sup>a</sup>	2024 ST Dural	12.53	2.745	
E-4864	PBX 9502	1.891	25.00	203.2	<sup>a</sup>	2024 ST Dural	24.96	2.533	
E-4861	PBX 9502	1.889	49.98	203.2	<sup>a</sup>	2024 ST Dural	6.32	3.162	28.5
E-4867	PBX 9502	1.889	49.95	203.2	<sup>a</sup>	2024 ST Dural	6.36	3.132	
E-4834	PBX 9502	1.889	49.99	203.2	<sup>a</sup>	2024 ST Dural	12.56	2.890	
E-4833	PBX 9502	1.887	49.97	203.2	<sup>a</sup>	2024 ST Dural	25.03	2.708	
E-4907	PBX 9502	1.890	49.96	203.2	<sup>a</sup>	2024 ST Dural	50.55	2.413	

<sup>a</sup>P-081 lens, 51.0-mm Comp B-3, and 6.3-mm 2024 ST Dural. It sends a shock of about 215 kbar into the PBX 9502 with a run distance of ~2.4 mm.

PLATE ACCELERATION DATA

Shot No.	Explosive	Density (g/cm <sup>3</sup> )	Charge Length (mm)	Charge Diameter (mm)	Booster	Plate Material	Plate Thickness (mm)	Free-Surface Velocity (mm/μs)	Effective C-J Pressure (GPa)
E-1378	PETN <sup>a</sup>	1.648	383	41.65	b	Dural	6.345	2.935	
F-1368	PETN <sup>a</sup>	1.648	383	41.65	b	Dural	4.963	2.939	
E-1372	PETN <sup>a</sup>	1.648	383	41.65	h	Dural	2.913	2.948	
E-1377	PETN <sup>a</sup>	1.648	383	41.65	b	Dural	1.989	2.995	
E-1376	PETN <sup>a</sup>	1.648	383	41.65	b	Dural	1.306	3.003	
E-1375	PETN <sup>a</sup>	1.648	383	41.65	b	Dural	0.920	3.062	
E-1379	PETN <sup>a</sup>	1.648	383	41.65	b	Dural	0.752	3.093	
E-1374	PETN <sup>a</sup>	1.648	383	41.65	b	Dural	0.569	3.230	
E-1497	PETN <sup>c</sup>	1.670	389	41.65	b	Dural	5.362	3.018	
E-1498	PETN <sup>c</sup>	1.670	389	41.65	b	Dural	2.819	3.078	
E-1499	PETN <sup>c</sup>	1.670	389	41.65	b	Dural	1.694	3.108	
E-1405	PETN <sup>d</sup>	1.670	374	41.65	b	Dural	6.134	2.990	
E-1406	PETN <sup>d</sup>	1.670	374	41.65	b	Dural	3.848	3.080	
E-1404	PETN <sup>d</sup>	1.670	374	41.65	b	Dural	1.682	3.117	
E-1407	PETN <sup>d</sup>	1.670	374	41.65	h	Dural	0.917	3.150	
E-1408	PETN <sup>d</sup>	1.670	374	41.65	b	Dural	0.544	3.254	
F-1409	PETN <sup>d</sup>	1.670	374	41.65	b	Dural	0.414	3.305	

<sup>a</sup>Coarse grain with a detonation velocity of 7923 m/s.

<sup>b</sup>SE-1 detonator and a 6.35-mm tetryl pellet.

<sup>c</sup>Coarse grain with a detonation velocity of 7995 m/s.

<sup>d</sup>Fine grain with a detonation velocity of 7974 m/s.

E-1985	TATB <sup>a</sup>	1.876	254	25.4	<sup>b</sup>	Dural	2.502	2.812	31.5
E-1986	TATB <sup>a</sup>	1.876	254	25.4	<sup>c</sup>	Dural	1.499	3.011	
E-1981	TATB <sup>a</sup>	1.874	508	50.8	<sup>b</sup>	Dural	2.512	3.066	
E-1993	TATB <sup>a</sup>	1.874	508	50.8	<sup>b</sup>	Dural	1.504	3.257	

<sup>a</sup>Detonation velocity is 7791 m/s.

<sup>b</sup>SE-1 detonator and a 12.7-mm tetryl pellet.

E-2183	TNT	0.733	101.6	609.6	<sup>a</sup>	Plexiglas	6.27	2.727	5.88
E-2182	TNT	0.731	101.6	609.6	<sup>a</sup>	Plexiglas	24.23	2.554	

<sup>a</sup>P-120 lens and 25.4-mm TNT.

F-1394	TNT <sup>a</sup>	1.051	625.3	78.1	P-022 lens	Dural	10.323	1.403	
E-1387	TNT <sup>a</sup>	1.050	625.3	78.1	P-022 lens	Dural	6.789	1.443	11.0
E-1388	TNT <sup>a</sup>	1.052	625.3	78.1	P-022 lens	Dural	4.516	1.600	
E-1389	TNT <sup>a</sup>	1.051	625.3	78.1	P-022 lens	Dural	2.903	1.697	
E-1390	TNT <sup>a</sup>	1.051	625.3	78.1	P-022 lens	Dural	1.735	1.827	
E-1391	TNT <sup>a</sup>	1.051	625.3	78.1	P-022 lens	Dural	0.907	2.057	
E-1392	TNT <sup>a</sup>	1.051	625.3	78.1	P-022 lens	Dural	0.340	2.533	
E-1393	TNT <sup>a</sup>	1.051	625.3	78.1	P-022 lens	Dural	0.749	2.164	

<sup>a</sup>Confined by 5.0 mm-thick brass.

E-1441	TNT	1.631	625.3	78.1	P-022 lens	Dural	2.835	2.541	
E-1442	TNT	1.628	625.3	78.1	P-022 lens	Dural	1.727	2.648	
E-1443	TNT	1.630	625.3	78.1	P-022 lens	Dural	0.831	2.792	
E-1445	TNT	1.631	625.3	78.1	P-022 lens	Dural	0.539	3.053	
E-1446	TNT	1.631	625.3	78.1	P-022 lens	Dural	0.379	3.188	

PLATE ACCELERATION DATA

Shot No.	Explosive	Density (g/cm <sup>3</sup> )	Charge Length (mm)	Charge Diameter (mm)	Booster	Plate Material	Plate Thickness (mm)	Free-Surface Velocity (mm/μs)	Effective C-J Pressure (GPa)
E-1437	TNT	1.629	625.3	78.1	P-022 lens	Dural	6.160	2.434	
E-1438	TNT	1.631	625.3	78.1	P-022 lens	Dural	4.630	2.476	
E-1266	TNT	1.633	762.0	50.8	<sup>a</sup>	2024 Dural	4.293	2.395	
E-1270	TNT	1.633	762.0	50.8	<sup>a</sup>	2024 Dural	5.438	2.367	
E-1282	TNT	1.633	762.0	50.8	<sup>a</sup>	2024 Dural	6.335	2.351	
E-1263	TNT	1.633	762.0	50.8	<sup>a</sup>	2024 Dural	1.148	2.600	
E-1264	TNT	1.633	762.0	50.8	<sup>a</sup>	2024 Dural	1.943	2.538	
E-1265	TNT	1.633	762.0	50.8	<sup>a</sup>	2024 Dural	2.812	2.468	
E-1279	TNT	1.633	762.0	50.8	<sup>a</sup>	2024 Dural	0.554	3.021	
E-1272	TNT	1.633	762.0	50.8	<sup>a</sup>	2024 Dural	0.625	2.890	
E-1273	TNT	1.633	762.0	50.8	<sup>a</sup>	2024 Dural	0.775	2.778	
E-1311	TNT	1.633	245.8	50.8	<sup>a</sup>	Plexiglas	6.769	3.551	
E-1298	TNT	1.633	245.8	50.8	<sup>a</sup>	Plexiglas	4.859	3.596	
E-1323	TNT	1.633	245.8	50.8	<sup>a</sup>	Plexiglas	3.660	3.909	
E-1304	TNT	1.633	245.8	50.8	<sup>a</sup>	Plexiglas	2.540	3.706	
E-1307	TNT	1.633	245.8	50.8	<sup>a</sup>	Plexiglas	1.943	4.102	
E-1300	TNT	1.633	245.8	50.8	<sup>a</sup>	Plexiglas	1.313	4.204	
E-1301	TNT	1.633	245.8	50.8	<sup>a</sup>	Plexiglas	0.793	4.543	
E-1274	TNT	1.633	762.0	50.8	<sup>a</sup>	Plexiglas	1.316	4.563	

<sup>a</sup>SE-1 detonator and a 6.35-mm tetryl pellet.

E-905	TNT <sup>a</sup>	1.639	508	25.4	<sup>b</sup>	Dural	2.65	2.151	15.5
E-906	TNT <sup>a</sup>	1.639	203	25.4	<sup>b</sup>	Dural	2.65	2.361	18.0
F-907	TNT <sup>a</sup>	1.639	254	25.4	<sup>b</sup>	Dural	2.65	2.392	18.3
E-923	TNT <sup>a</sup>	1.639	305	25.4	<sup>b</sup>	Dural	2.65	2.379	18.2
E-941	TNT <sup>a</sup>	1.639	406	25.4	<sup>b</sup>	Dural	2.68	2.362	18.1

<sup>a</sup>TNT was encased in 5.0-mm-thick brass tubes.

<sup>b</sup>IE15 detonator and a 127-mm tetryl pellet.

8A-1863	TNT <sup>a</sup>	1.455	304.8	203.2	<sup>b</sup>	2024 Dural	3.81	2.398	171.8
8A-1890	TNT <sup>a</sup>	1.455	304.8	203.2	<sup>b</sup>	2024 Dural	6.35	2.375	
8A-1894	TNT <sup>a</sup>	1.455	304.8	203.2	<sup>b</sup>	2024 Dural	12.70	2.355	
8A-1893	TNT <sup>a</sup>	1.455	304.8	203.2	<sup>b</sup>	2024 Dural	25.40	2.254	
8A-1864	TNT <sup>a</sup>	1.455	228.6	203.2	<sup>b</sup>	2024 Dural	3.81	2.402	
8A-1886	TNT <sup>a</sup>	1.455	609.6	203.2	<sup>b</sup>	2024 Dural	3.81	2.397	

<sup>a</sup>Liquid TNT at 92°C. See J. Chem. Phys. 32, 653 (1960).

<sup>b</sup>P-080 lens, 50.8-mm Comp B, and 31.75-mm Micarta.

Shot No.	Explosive	Density (g/cm <sup>3</sup> )	Charge Length (mm)	Charge Diameter (mm)	Booster	Plate Material	Plate Thickness (mm)	Free-Surface Velocity (mm/μs)	Effective C-J Pressure (GPa)
E-913	Toluene/NM <sup>a</sup>	1.088	304	19.0	<sup>b</sup>	Dural	2.66	1.533	10.1
E-914	Toluene/NM <sup>a</sup>	1.088	508	31.7	<sup>b</sup>	Dural	2.66	1.597	
E-915	Toluene/NM <sup>a</sup>	1.088	813	50.8	<sup>b</sup>	Dural	2.66	1.601	

<sup>a</sup>14.5 wt% toluene/85.5 wt% nitromethane with a detonation velocity of 5850 m/s. confined by 6.35-mm-thick brass.

<sup>b</sup>P-022 lens and 25.4-mm Comp B.

E-1451	X-0007 <sup>a</sup>	1.738	508	50.8	<sup>b</sup>	Dural	1.295	3.189	31.0
E-1452	X-0007 <sup>a</sup>	1.738	508	50.8	<sup>b</sup>	Dural	2.068	3.094	
E-1453	X-0007 <sup>a</sup>	1.738	254	25.4	<sup>b</sup>	Dural	2.068	2.902	
E-1454	X-0007 <sup>a</sup>	1.738	254	25.4	<sup>b</sup>	Dural	1.295	3.031	

<sup>a</sup>86.36 wt% HMX/13.64 wt% Estane with a detonation velocity of 8358 m/s.

<sup>b</sup>SE-1 detonator and a 127-mm tetryl pellet with unconfined charges.

E-1501	X-0008 <sup>a</sup>	1.767	508	50.8	<sup>b</sup>	Dural	2.073	3.203	32.4
E-1502	X-0008 <sup>a</sup>	1.767	508	50.8	<sup>b</sup>	Dural	1.308	3.273	
E-1503	X-0008 <sup>a</sup>	1.768	254	25.4	<sup>b</sup>	Dural	1.318	3.201	
E-1504	X-0008 <sup>a</sup>	1.768	254	25.4	<sup>b</sup>	Dural	2.065	3.037	

<sup>a</sup>89.97 wt% HMX/10.03 wt% Estane with a detonation velocity of 8500 m/s.

<sup>b</sup>SE-1 detonator and a 6.35-mm tetryl pellet.

E 1447	X-0009 <sup>a</sup>	1.80	508	50.8	<sup>b</sup>	Dural	2.068	3.237	33.8
E-1448	X-0009 <sup>a</sup>	1.80	508	50.8	<sup>b</sup>	Dural	1.308	3.369	
E 1449	X-0009 <sup>a</sup>	1.80	254	25.4	<sup>b</sup>	Dural	1.303	3.219	
E-1450	X 0009 <sup>a</sup>	1.80	254	25.4	<sup>b</sup>	Dural	2.065	3.079	
E-1468	X-0009 <sup>a</sup>	1.80	152.4	50.8	P-022 lens	Dural	6.139	3.221	
E-1478	X-0009 <sup>a</sup>	1.80	152.4	50.8	P-022 lens	Dural	4.963	3.244	
E-1469	X-0009 <sup>a</sup>	1.80	152.4	50.8	P-022 lens	Dural	3.846	3.264	
E-1470	X-0009 <sup>a</sup>	1.80	152.4	50.8	P-022 lens	Dural	1.303	3.422	
E-1471	X-0009 <sup>a</sup>	1.80	152.4	50.8	P-022 lens	Dural	0.917	3.452	
E-1472	X-0009 <sup>a</sup>	1.80	152.4	50.8	P-022 lens	Dural	0.539	3.704	

<sup>a</sup>93.44 wt% HMX/6.56 Estane with a detonation velocity of 8672 m/s.

<sup>b</sup>SE-1 detonator and a 127-mm tetryl pellet with unconfined charges.

B-5327	X-0118 <sup>a</sup>	1.711	508	50.8	<sup>b</sup>	Dural	1.041	3.182	30.1
B-5326	X-0118 <sup>a</sup>	1.711	508	50.8	<sup>b</sup>	Dural	2.306	2.960	
B-5329	X-0118 <sup>a</sup>	1.712	254	25.4	<sup>b</sup>	Dural	1.041	3.057	

<sup>a</sup>64.88 wt% nitroguanidine/29.68 wt% HMX/5.43 wt% Estane with detonation velocity of 8378 m/s.

<sup>b</sup>SE-1 detonator and a tetryl pellet with unconfined charges.

E-1522	X-0143 <sup>a</sup>	1.797	508	50.8	<sup>b</sup>	Dural	2.459	3.277	34.3
E-1523	X-0143 <sup>a</sup>	1.797	508	50.8	<sup>b</sup>	Dural	1.412	3.454	
E-1520	X-0143 <sup>a</sup>	1.800	254	25.4	<sup>b</sup>	Dural	2.464	3.158	
E 1521	X-0143 <sup>a</sup>	1.800	254	25.4	<sup>b</sup>	Dural	1.405	3.362	

<sup>a</sup>9.19 wt% DATB/85.58 wt% HMX/5.22 wt% Estane with a detonation velocity of 8573 m/s.

<sup>b</sup>SE-1 detonator and a tetryl pellet with unconfined charges.

PLATE ACCELERATION DATA



Shot No.	Explosive	Density (g/cm <sup>3</sup> )	Charge Length (mm)	Charge Diameter (mm)	Booster	Plate Material	Plate Thickness (mm)	Free-Surface Velocity (mm/μs)	Effective C-J Pressure (GPa)
E-1515	X-0183 <sup>a</sup>	1.811	508	50.8	b	Dural	2.469	3.320	34.6
E-1516	X-0183 <sup>a</sup>	1.811	508	50.8	b	Dural	1.689	3.422	
E-1517	X-0183 <sup>a</sup>	1.819	254	25.4	b	Dural	2.466	3.107	
E-1519	X-0183 <sup>a</sup>	1.819	254	25.4	b	Dural	1.689	3.237	

<sup>a</sup>26.37 wt% nitroguanidine/65.68 wt% HMX/7.95 wt% KCl-F with a detonation velocity of 8627 m/s.

<sup>b</sup>SE-1 detonator and a tetryl pellet with unconfined charges.

B-5315	X-0191 <sup>a</sup>	1.824	508	50.8	b	Dural	2.827	3.34	36.5
B-5316	X-0191 <sup>a</sup>	1.824	508	50.8	b	Dural	1.707	3.50	
B-5319	X-0191 <sup>a</sup>	1.827	254	25.4	b	Dural	1.699	3.397	
B-5320	X-0191 <sup>a</sup>	1.827	254	25.4	b	Dural	2.832	3.281	

<sup>a</sup>93.07 wt% HMX/2.97 wt% NC/2.97 wt% CEF/0.99 wt% wax with a detonation velocity of 8720 m/s.

<sup>b</sup>SE-1 detonator and a 6.35-mm tetryl pellet.

E-1459	X-0192 <sup>a</sup>	1.854	254	25.4	b	Dural	1.295	3.330	35.3
E-1460	X-0192 <sup>a</sup>	1.854	254	25.4	b	Dural	2.073	3.224	
E-1461	X-0192 <sup>a</sup>	1.850	508	50.8	b	Dural	2.073	3.390	
E-1462	X-0192 <sup>a</sup>	1.850	508	50.8	b	Dural	1.290	3.493	

<sup>a</sup>85 wt% HMX/15 wt% Viton with a detonation velocity of 8430 m/s.

<sup>b</sup>SE-1 detonator and a 12.7-mm tetryl pellet with an unconfined charge.

E-1767	X-0204 <sup>a</sup>	1.908	508	50.8	<sup>b</sup>	Dural	2.024	3.588	36.5
E-1768	X-0204 <sup>a</sup>	1.908	508	50.8	<sup>b</sup>	Dural	1.250	3.617	
E-1771	X-0204 <sup>a</sup>	1.908	254	25.4	<sup>b</sup>	Dural	2.024	3.352	
E-1772	X-0204 <sup>a</sup>	1.908	254	25.4	<sup>b</sup>	Dural	1.247	3.405	

<sup>a</sup>83.4 wt% HMX/16.6 wt% Teflon with a detonation velocity of 8443 m/s.

<sup>b</sup>SE-1 detonator and a 12.7 mm tetryl pellet with unconfined charges.

E-3759	X-0219 <sup>a</sup>	1.91	19.05	63.5	<sup>b</sup>	2024 Dural	0.734	3.408	27.8
E-3758	X-0219 <sup>a</sup>	1.91	19.05	63.5	<sup>b</sup>	2024 Dural	0.912	3.468	
E-3757	X-0219 <sup>a</sup>	1.91	19.05	63.5	<sup>b</sup>	2024 Dural	1.499	3.267	
E-3753	X-0219 <sup>a</sup>	1.91	19.05	63.5	<sup>b</sup>	2024 Dural	1.979	3.112	
E-3760	X-0219 <sup>a</sup>	1.91	19.05	63.5	<sup>b</sup>	2024 Dural	2.002	3.212	
E-3761	X-0219 <sup>a</sup>	1.91	19.05	63.5	<sup>b</sup>	2024 Dural	2.492	3.119	
E-3752	X-0219 <sup>a</sup>	1.91	19.05	63.5	<sup>b</sup>	2024 Dural	2.494	3.058	
E-3771	X-0219 <sup>a</sup>	1.91	19.05	63.5	<sup>b</sup>	2024 Dural	3.759	2.985	
E-3754	X-0219 <sup>a</sup>	1.91	19.05	63.5	<sup>b</sup>	6061 Dural	5.034	2.899	
E-3755	X-0219 <sup>a</sup>	1.91	19.05	63.5	<sup>b</sup>	6061 Dural	7.536	2.785	
E-3756	X-0219 <sup>a</sup>	1.91	19.05	63.5	<sup>b</sup>	6061 Dural	10.036	2.636	
E-3770	X-0219 <sup>a</sup>	1.91	19.05	63.5	<sup>b</sup>	6061 Dural	10.114	2.614	
E-3769	X-0219 <sup>a</sup>	1.91	56.93	152.0	<sup>c</sup>	6061 Dural	5.050	3.174	27.8
E-3763	X-0219 <sup>a</sup>	1.91	56.93	152.0	<sup>c</sup>	6061 Dural	7.600	3.068	
E-3762	X-0219 <sup>a</sup>	1.91	56.93	152.0	<sup>c</sup>	6061 Dural	19.020	2.789	
E-3764	X-0219 <sup>a</sup>	1.91	56.93	152.0	<sup>c</sup>	6061 Dural	30.404	2.622	
E-3768	X-0219 <sup>a</sup>	1.91	56.93	152.0	<sup>c</sup>	6061 Dural	30.429	5.342	

<sup>a</sup>90 wt% TATB/10 wt% Kel-F.

<sup>b</sup>P-081 lens and 8.47-mm TNT.

<sup>c</sup>P-081 lens and 25.4-mm TNT.

PLATE ACCELERATION DATA



## PART II

# AQUARIUM DATA

The aquarium experiment was developed to measure simultaneously detonation velocity and pressure, confinement effects, and the release isentrope from the Chapman-Jouguet state. It consists of an explosive cylinder placed in a water tank with two parallel transparent sides, as shown in Fig. 1.

The explosive may be contained within a watertight tube or pipe if varied confinement is desirable. If the explosive is unaffected by water and is rigid, it can be placed directly in the

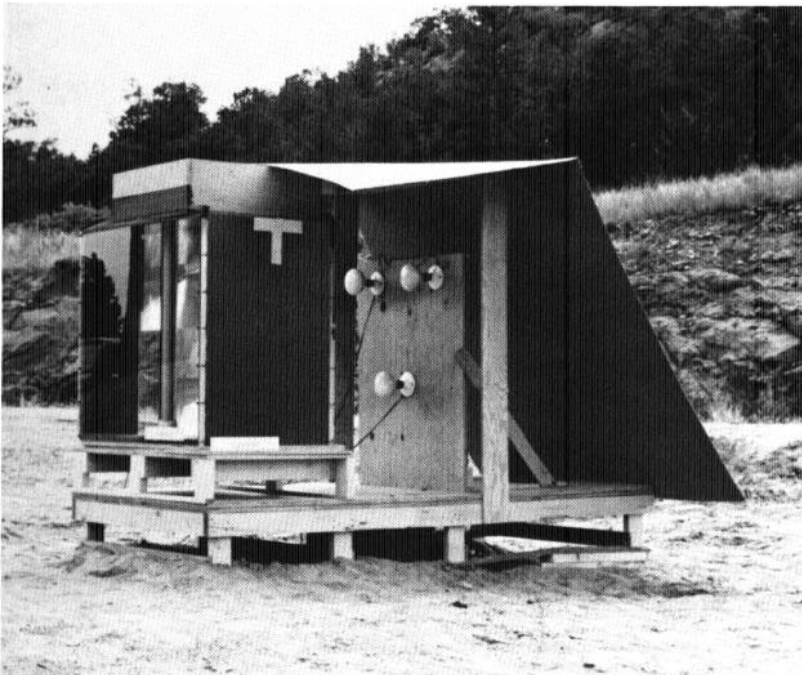

Fig. 1. Water tank containing explosive column.

## AQUARIUM DATA

water tank without confinement. The explosive cylinder is detonated from above. As the detonation wave travels downward, an oblique shock wave radiates into the water, and the gaseous products behind the detonation front expand.

Several photographic exposures are taken of the detonation front, the shock waves in the water, and the expanding tube-water interface (or bubble-water interface if the tube is absent). This optical data, shown schematically in Fig. 2, is used to infer detonation velocity, detonation pressure (C-J states), and the release isentrope of the detonation products.<sup>1-3</sup>

The 40-mm image intensifier camera (I<sup>2</sup>C) that is used was fabricated at Los Alamos National Laboratory.<sup>4</sup> The 40-mm I<sup>2</sup>C tube can resolve approximately 16 line pairs per

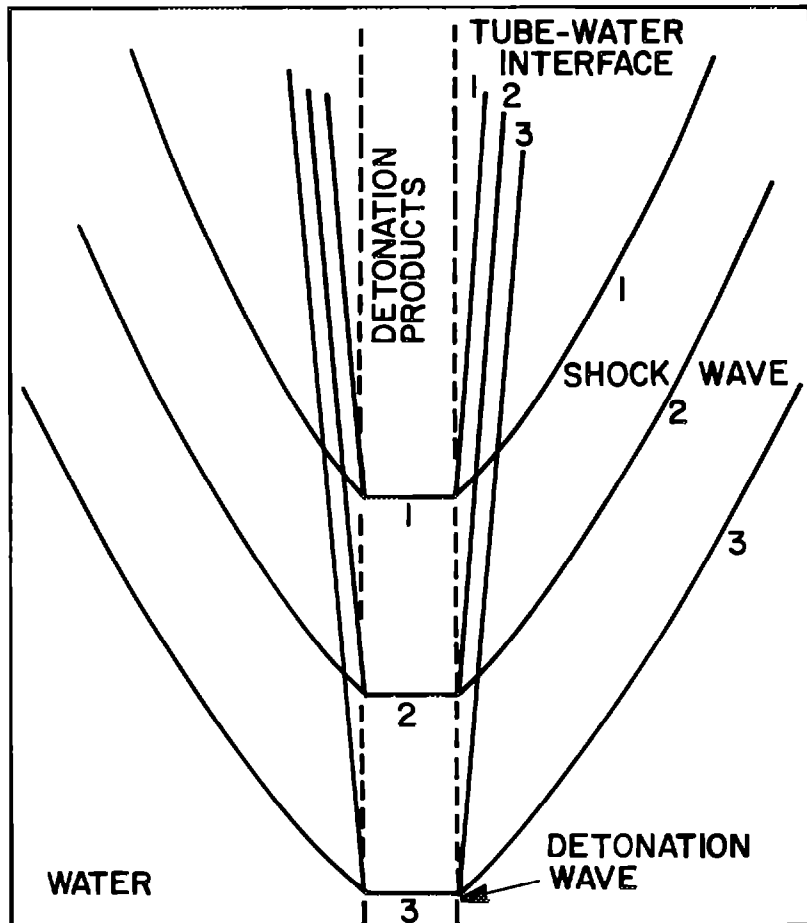

Fig. 2. Schematic diagram of typical I<sup>2</sup>C record. Three exposures (1, 2, and 3) are shown here.

millimeter over the whole frame and has a useful light gain of about 625. The exposure times in the experiments are approximately 175 ns. Photographic floodlights are used with four Fresnel lenses or a Mylar sheet, depending on whether collimated or diffused light is required. In specific cases of very high detonation pressures, index-of-refraction effects prevent observation of the expanding tube or bubble when collimated light is used.

The actual photographic record of Shot C-4632 is shown in Fig. 3. In this test, ANFO (94 wt%  $\text{NH}_4\text{NO}_3$  and 6 wt% fuel oil) was contained in a 10-cm-diam Plexiglas tube. Positions of detonation fronts, shock waves, and tube-water interfaces for three exposures are the same as those shown schematically in Fig. 2.

We present the aquarium test data with a description of each explosive; its confinement, if any; the time between  $\text{I}^2\text{C}$  exposures; and the x,y-position coordinates of the bubble or tube-water interfaces and of the shock fronts. No corrections were made for index-of-refraction effects, and no interpretation of the data is given. Previous interpretations, where attempted, are presented in Refs. 1 through 3.

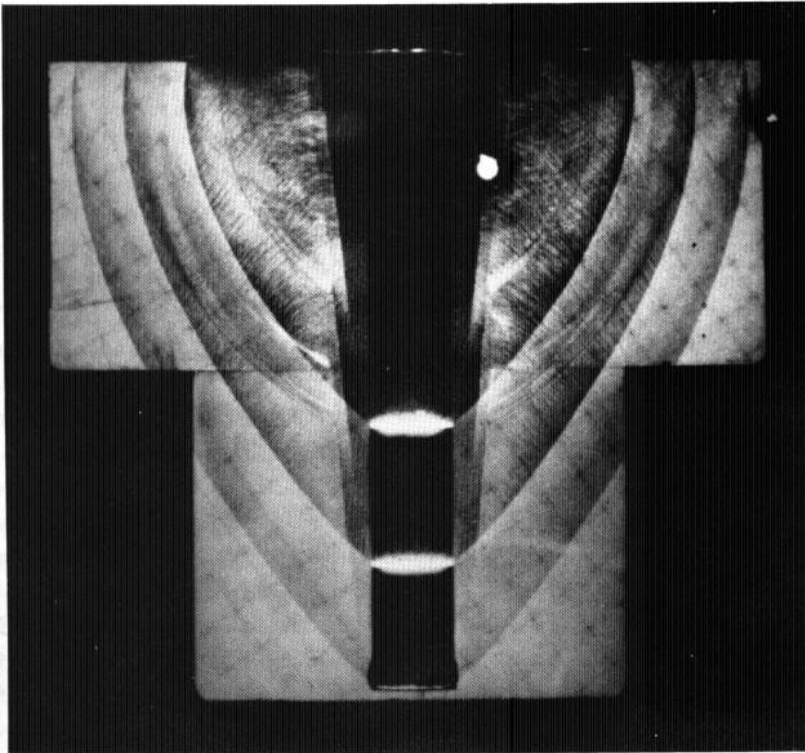

Fig. 3.  $\text{I}^2\text{C}$  photograph for Shot C-4632, a 10-cm-diam Plexiglas tube containing ANFO.

## AQUARIUM DATA

Clay pipe was often used as the confining tube. Density, porosity, and ultrasonic wave velocity were measured at various locations on one particular pipe.<sup>5</sup> Longitudinal and shear wave velocities,  $C_L$  and  $C_s$ , were measured for radial propagation directions, and these are given in Table I.

TABLE I. Ultrasonic Wave Velocities for Clay Pipe

$\rho_0$ (g/cm <sup>3</sup> )	Porosity (%)	$C_L$ (mm/ $\mu$ s)	$C_s$ (mm/ $\mu$ s)
2.342	0.6	4.37	2.96
2.328	2.2	4.33	2.94
2.315	1.4	4.18	2.89
2.339	1.5	4.31	2.98
2.315	2.5	4.45	2.94
2.308	0.8	4.49	3.03
2.457	1.1	4.35	2.94

## REFERENCES

1. B. G. Craig, J. N. Johnson, C. L. Mader, and G. F. Lederman, "Characterization of Two Commercial Explosives," Los Alamos Scientific Laboratory report LA-7140 (May 1978).
2. S. Goldstein and J. N. Johnson, "Aquarium Tests on Aluminized ANFO," Seventh Symposium (International) on Detonation, June 16-19, 1981, Annapolis, Maryland, (preprint, pp. 524-530).
3. J. N. Johnson, C. L. Mader, and S. Goldstein, "Performance Properties of Commercial Explosives," submitted to the Journal of Propellants and Explosives, 1981.
4. O. G. Winslow, W. C. Davis, and W. C. Chiles, "Multiple Exposure Image-Intensifier Camera," *Proceedings of the Sixth Symposium (International) on Detonation, August 24-27, 1976, Coronado, California*, Office of Naval Research symposium report ACR-221 (1976), pp. 664-667.
5. B. W. Olinger, Los Alamos Scientific Laboratory, Group M-6, unpublished data, December 1976.

**Data List**

ANFO, $\rho_0 = 0.76 \text{ g/cm}^3$ , Shot C-5084	29
ANFO, $\rho_0 = 0.78 \text{ g/cm}^3$ , Shot C-5147	36
ANFO, $\rho_0 = 0.787 \text{ g/cm}^3$ , Shot C-4688	43
ANFO, $\rho_0 = 0.793 \text{ g/cm}^3$ , Shot C-4678	47
ANFO, $\rho_0 = 0.80 \text{ g/cm}^3$ , Shot C-5058	52
ANFO, $\rho_0 = 0.896 \text{ g/cm}^3$ , Shot C-4700	58
ANFO, $\rho_0 = 0.897 \text{ g/cm}^3$ , Shot C-4652	62
ANFO, $\rho_0 = 0.901 \text{ g/cm}^3$ , Shot C-4664	66
ANFO, $\rho_0 = 0.931 \text{ g/cm}^3$ , Shot C-4768	71
ANFO, $\rho_0 = 0.954 \text{ g/cm}^3$ , Shot C-4632	77
ANFO with distributed charge, $\rho = 0.797 \text{ g/cm}^3$ , Shot C-4717	85
ANFO/7.5 wt% aluminum, $\rho_0 = 1.10 \text{ g/cm}^3$ , Shot C-4748	89
ANFO/7.5 wt% aluminum, $\rho_0 = 1.11 \text{ g/cm}^3$ , Shot C-4752	92
ANFO/7.5 wt% aluminum, $\rho_0 = 0.77 \text{ g/cm}^3$ , Shot C-5125	97
ANFO/7.5 wt% aluminum, $\rho_0 = 0.874 \text{ g/cm}^3$ , Shot C-4724	104
ANFO/7.5 wt% aluminum, $\rho_0 = 0.877 \text{ g/cm}^3$ , Shot C-4707	107
ANFO/7.5 wt% aluminum, $\rho_0 = 1.06 \text{ g/cm}^3$ , Shot C-4743	111
ANFO/10.8 wt% aluminum, $\rho_0 = 0.80 \text{ g/cm}^3$ , Shot C-5088	114
ANFO/18.91 wt% aluminum, $\rho_0 = 0.93 \text{ g/cm}^3$ , Shot C-5066	121
ANFO/19.32 wt% aluminum, $\rho_0 = 0.90 \text{ g/cm}^3$ , Shot C-5097	127
DBA-1, $\rho_0 = 1.47 \text{ g/cm}^3$ , Shot C-4691	133
DBA-1, $\rho_0 = 1.496 \text{ g/cm}^3$ , Shot C-4663	137
Destex, $\rho_0 = 1.696 \text{ g/cm}^3$ , Shot C-4716	141
Nitromethane, $\rho_0 = 1.13 \text{ g/cm}^3$ , Shot C-4868	143
Nitromethane, $\rho_0 = 1.13 \text{ g/cm}^3$ , Shot C-5017	148
PBX 9404, $\rho_0 = 1.84 \text{ g/cm}^3$ , Shot C-4728	153
PBX 9404, $\rho_0 = 1.84 \text{ g/cm}^3$ , Shot C-4785	156
PBX 9404, $\rho_0 = 1.84 \text{ g/cm}^3$ , Shot C-4981	159
PBX 9404, $\rho_0 = 1.844 \text{ g/cm}^3$ , Shot C-4769	162
PBX 9407, $\rho_0 = 1.6 \text{ g/cm}^3$ , Shot C-4809	166
PBX 9407, $\rho_0 = 1.61 \text{ g/cm}^3$ , Shot C-4628	169
PBX 9407, $\rho_0 = 1.61 \text{ g/cm}^3$ , Shot C-5023	173
PBX 9501, $\rho_0 = 1.84 \text{ g/cm}^3$ , Shot C-4971	183
PBX 9501, $\rho_0 = 1.84 \text{ g/cm}^3$ , Shot C-4972	188
PBX 9501, $\rho_0 = 1.84 \text{ g/cm}^3$ , Shot C-5167	193
PBX 9501, $\rho_0 = 1.84 \text{ g/cm}^3$ , Shot C-5168	197
PBX 9502, $\rho_0 = 1.891 \text{ g/cm}^3$ , Shot C-5149	202
PBX 9502, $\rho_0 = 1.893 \text{ g/cm}^3$ , Shot C-4976	213



**AQUARIUM DATA**

RDX/Fairy dust, $\rho_0 = 1.718 \text{ g/cm}^3$ , Shot C-4730 . . . . .	218
Stratablast-C, $\rho_0 = 1.188 \text{ g/cm}^3$ , Shot C-4771 . . . . .	221
TAL-1005E, $\rho_0 = 1.304 \text{ g/cm}^3$ , Shot C-4791 . . . . .	224
TAL-1005E, $\rho_0 = 1.304 \text{ g/cm}^3$ , Shot C-4805 . . . . .	227
TNT Flake #1, $\rho_0 = 0.762 \text{ g/cm}^3$ , Shot C-4692 . . . . .	232
TNT Flake #1, $\rho_0 = 0.849 \text{ g/cm}^3$ , Shot C-4695 . . . . .	236
X-0320, $\rho_0 = 1.880 \text{ g/cm}^3$ , Shot C-5034 . . . . .	239
X-0321, $\rho_0 = 1.881 \text{ g/cm}^3$ , Shot C-4992 . . . . .	246
X-0341, $\rho_0 = 1.908 \text{ g/cm}^3$ , Shot C-5036 . . . . .	249

AQUARIUM DATA

Material: ANFO Shot no.: C-5084

Experimenter: S. Goldstein Date: November 25, 1980

Charge diameter: 10 cm Charge length: 91.4 cm

Initial density:  $0.76 \text{ g/cm}^3$  Temperature: 277 K

Confinement: 1.6-cm clay pipe in water

Booster: One 1E23 detonator, one P-040 lens, and two 10.2-cm-diam by 1.3-cm-long Comp B charges

Exposures of image intensifier camera: Two

Time between exposures:  $29.02 \mu\text{s}$  Detonation velocity: 2.88 km/s

Notes: ANFO is Gulf N-C-N 100 manufactured by Gulf Oil Chemical Co., Merriam, Kansas

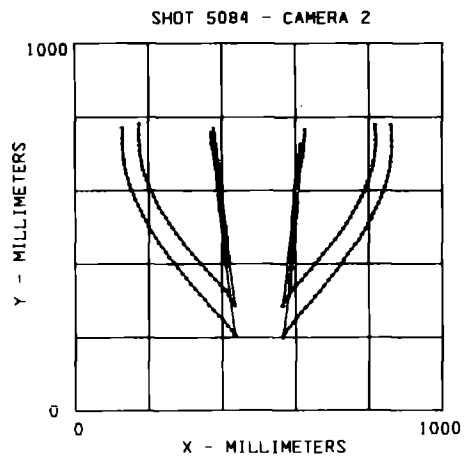
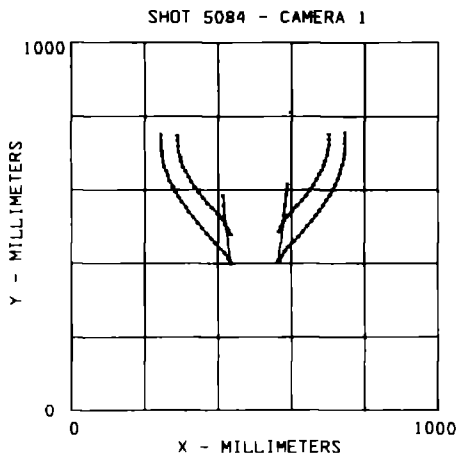

AQUARIUM DATA

SHOT 5084 - Camera 1  
EXPLOSIVE (PIPE) - WATER INTERFACE POSITIONS

Exposure 2

Left			Right		
<i>n</i>	<i>x (mm)</i>	<i>y (mm)</i>	<i>n</i>	<i>x (mm)</i>	<i>y (mm)</i>
1	412.8	583.9	5	587.6	613.8
2	415.4	556.0	6	585.5	585.8
3	416.8	528.1	7	581.7	557.8
4	435.0	400.0	8	578.7	529.9
			9	565.0	404.6

SHOCK FRONT POSITIONS

Exposure 1

Left			Right		
<i>n</i>	<i>x (mm)</i>	<i>y (mm)</i>	<i>n</i>	<i>x (mm)</i>	<i>y (mm)</i>
10	290.2	748.2	30	702.7	753.6
11	289.5	734.2	31	703.0	739.7
12	290.9	720.1	32	702.5	725.7
13	292.2	706.0	33	700.4	711.7
14	295.9	691.9	34	697.7	697.7
15	300.6	677.8	35	693.9	683.8
16	305.5	663.7	36	688.6	669.8
17	311.7	649.6	37	682.6	655.6
18	319.5	635.6	38	675.7	641.7
19	327.1	621.6	39	668.4	627.8
20	335.9	607.4	40	659.4	613.8
21	347.3	593.3	41	649.6	599.7
22	358.2	579.2	42	639.5	585.7
23	370.5	565.1	43	627.8	571.7
24	383.3	551.0	44	615.6	557.7
25	397.5	537.0	45	602.2	543.8
26	410.5	522.9	46	588.9	529.8
27	419.0	508.9	47	578.7	515.9
28	426.7	494.8	48	570.9	501.9
29	435.0	480.6	49	565.0	488.0

AQUARIUM DATA

Exposure 2

Left			Right		
<u>n</u>	<u>x (mm)</u>	<u>y (mm)</u>	<u>n</u>	<u>x (mm)</u>	<u>y (mm)</u>
50	245.3	749.4	76	746.7	756.3
51	245.4	735.4	77	747.4	742.2
52	245.6	721.5	78	747.4	728.2
53	246.0	707.5	79	747.3	714.1
54	247.9	693.5	80	745.5	700.0
55	250.7	679.5	81	743.3	685.9
56	253.7	665.5	82	739.8	671.8
57	258.4	651.6	83	735.8	657.7
58	263.0	637.6	84	731.4	643.7
59	268.9	623.7	85	726.0	629.6
60	276.4	609.7	86	719.5	615.6
61	283.9	595.7	87	713.0	601.5
62	291.8	581.7	88	704.7	587.3
63	300.4	567.7	89	695.5	573.3
64	310.9	553.7	90	687.2	559.2
65	320.4	539.8	91	676.5	545.2
66	330.9	525.9	92	666.1	531.1
67	343.4	511.9	93	655.5	517.1
68	354.5	497.9	94	642.0	503.0
69	367.8	483.9	95	629.7	489.0
70	379.4	469.9	96	617.9	474.9
71	392.8	455.9	97	604.8	460.8
72	404.7	441.9	98	592.4	446.6
73	419.1	428.0	99	583.6	432.8
74	428.1	414.0	100	572.5	418.7
75	435.0	400.0	101	565.0	404.6

SHOT 5084 - Camera 2

EXPLOSIVE (PIPE) - WATER INTERFACE POSITIONS

Exposure 1

Left			Right		
<u>n</u>	<u>x (mm)</u>	<u>y (mm)</u>	<u>n</u>	<u>x (mm)</u>	<u>y (mm)</u>
1	379.1	768.1	29	615.6	724.9
2	380.1	754.0	30	613.0	710.7
3	381.3	739.9	31	611.0	696.6

**AQUARIUM DATA**

4	382.9	725.8	32	608.4	682.6
5	384.2	711.7	33	606.4	668.5
6	385.8	697.5	34	604.6	654.5
7	388.7	683.5	35	603.1	640.3
8	390.0	669.4	36	601.4	626.1
9	392.4	655.4	37	599.4	611.8
10	393.8	641.2	38	597.1	597.7
11	394.7	627.1	39	596.9	583.5
12	396.3	613.0	40	596.4	569.3
13	397.2	598.9	41	595.3	555.3
14	398.2	584.6	42	593.7	541.3
15	399.9	570.5	43	592.1	527.0
16	401.4	556.4	44	590.9	513.0
17	402.9	542.4	45	589.6	498.8
18	405.3	528.3	46	588.5	484.7
19	407.4	514.0	47	586.9	470.7
20	409.3	499.7	48	586.3	456.4
21	410.8	485.7	49	585.1	442.3
22	412.6	471.6	50	583.0	428.1
23	414.4	457.4	51	581.5	413.9
24	415.6	443.4	52	565.0	287.0
25	417.0	429.4			
26	419.5	415.1			
27	420.3	401.1			
28	435.0	288.0			

**Exposure 2**

<u>Left</u>			<u>Right</u>		
<i>n</i>	<i>x (mm)</i>	<i>y (mm)</i>	<i>n</i>	<i>x (mm)</i>	<i>y (mm)</i>
53	370.9	757.0	80	626.2	764.5
54	371.6	742.8	81	626.4	750.5
55	372.4	728.7	82	625.6	736.3
56	374.8	714.6	83	623.7	722.0
57	377.5	700.4	84	621.8	707.9
58	379.2	686.1	85	620.2	693.8
59	381.3	672.1	86	617.0	679.7
60	383.8	657.9	87	613.7	665.7
61	386.3	643.8	88	611.0	651.4
62	386.6	629.5	89	609.6	637.4
63	388.3	615.4	90	608.6	623.3

AQUARIUM DATA

64	389.6	601.3	91	607.1	609.1
65	390.8	587.2	92	605.4	580.8
66	391.1	573.0	93	604.3	566.5
67	392.1	558.8	94	602.8	552.4
68	392.9	544.6	95	601.3	538.4
69	396.5	530.6	96	599.9	524.2
70	398.7	516.4	97	599.0	510.1
71	400.6	502.1	98	597.3	495.9
72	402.4	488.0	99	596.1	481.7
73	403.7	473.9	100	595.0	467.7
74	404.5	459.7	101	593.8	453.6
75	405.4	445.7	102	592.4	439.5
76	406.7	431.5	103	591.2	425.4
77	407.9	417.5	104	590.4	411.4
78	409.5	403.3	105	589.3	397.3
79	435.0	205.2	106	587.9	383.1
			107	586.6	369.0
			108	585.1	354.9
			109	584.3	340.9
			110	565.0	200.0

SHOCK FRONT POSITIONS

Exposure 1

Left			Right		
<i>n</i>	<i>x</i> (mm)	<i>y</i> (mm)	<i>n</i>	<i>x</i> (mm)	<i>y</i> (mm)
111	176.3	781.1	147	817.6	780.7
112	175.8	767.1	148	819.1	766.6
113	175.0	753.0	149	819.3	752.6
114	174.6	739.0	150	819.3	738.4
115	175.9	724.8	151	819.3	724.3
116	176.6	710.7	152	818.1	710.2
117	179.1	696.6	153	816.9	696.1
118	181.5	682.5	154	814.0	682.0
119	183.9	668.4	155	811.0	668.0
120	187.4	654.4	156	807.0	653.9
121	191.3	640.3	157	802.9	639.9
122	196.7	626.3	158	797.8	625.7
123	201.7	612.0	159	791.9	611.6
124	208.0	598.0	160	786.3	597.5

**AQUARIUM DATA**

125	214.9	583.8	161	780.1	583.4
126	221.6	569.7	162	772.7	569.2
127	228.6	555.7	163	765.4	555.2
128	237.0	541.6	164	757.1	541.1
129	245.9	527.6	165	748.1	527.0
130	255.6	513.4	166	739.5	512.9
131	265.3	499.3	167	730.0	498.7
132	275.6	485.2	168	719.6	484.5
133	285.6	471.1	169	708.9	470.3
134	295.9	457.0	170	698.7	456.1
135	306.7	443.0	171	688.6	442.0
136	318.9	428.9	172	676.7	428.0
137	330.8	414.8	173	665.2	413.9
138	343.0	400.7	174	653.1	399.8
139	355.3	386.6	175	641.2	385.6
140	368.2	372.5	176	628.6	371.6
141	381.0	358.4	177	616.2	357.4
142	395.4	344.3	178	602.1	343.3
143	407.5	330.3	179	590.4	329.3
144	416.6	316.2	180	582.1	315.3
145	425.5	302.1	181	570.4	301.2
146	435.0	288.0	182	565.0	287.0

**Exposure 2**

<u>Left</u>			<u>Right</u>		
<u>n</u>	<u>x (mm)</u>	<u>y (mm)</u>	<u>n</u>	<u>x (mm)</u>	<u>y (mm)</u>
183	130.6	772.0	224	862.4	778.7
184	130.7	757.9	225	863.5	764.6
185	130.1	743.9	226	863.5	750.6
186	129.6	729.8	227	863.6	736.5
187	130.5	715.4	228	863.2	722.3
188	131.3	701.4	229	863.1	708.3
189	133.0	687.1	230	861.9	694.1
190	135.1	673.0	231	860.0	680.0
191	137.6	659.0	232	857.6	666.0
192	140.8	644.9	233	855.0	651.9
193	144.9	630.9	234	851.8	637.9
194	148.9	616.8	235	847.9	623.8
195	153.3	602.5	236	843.1	609.6
196	159.4	588.4	237	838.5	595.7

AQUARIUM DATA

197	164.6	574.3	238	832.8	581.6
198	170.9	560.1	239	826.9	567.4
199	177.6	546.0	240	820.4	553.4
200	185.6	531.8	241	813.8	539.3
201	193.0	517.6	242	806.4	525.2
202	200.4	503.4	243	798.6	511.1
203	208.7	489.1	244	790.3	497.0
204	218.4	474.9	245	781.8	482.9
205	228.5	460.7	246	772.6	468.8
206	238.5	446.6	247	762.7	454.7
207	247.6	432.4	248	753.9	440.6
208	256.7	418.2	249	743.5	426.6
209	269.7	404.0	250	733.5	412.4
210	280.3	389.7	251	723.5	398.3
211	291.9	375.5	252	712.8	384.1
212	303.9	361.3	253	701.4	370.0
213	315.7	347.1	254	690.0	355.9
214	327.0	332.9	255	677.9	341.7
215	340.1	318.7	256	666.2	327.5
216	352.5	304.6	257	653.7	313.4
217	363.7	290.4	258	642.0	299.1
218	376.9	276.1	259	628.9	284.9
219	390.3	261.9	260	615.5	270.7
220	403.8	247.7	261	602.7	256.6
221	414.6	233.5	262	593.0	242.6
222	425.8	219.3	263	582.2	228.4
223	435.0	205.2	264	572.1	214.2
			265	565.0	200.0



**AQUARIUM DATA**

**Material:** ANFO    **Shot no.:** C-5147

**Experimenter:** S. Goldstein    **Date:** May 20, 1981

**Charge diameter:** 10 cm    **Charge length:** 91.4 cm

**Initial density:** 0.78 g/cm<sup>3</sup>    **Temperature:** 292 K

**Confinement:** 0.8-mm acetate pipe

**Booster:** One 1E23 detonator, one P-040 lens, and a 10.2-cm-diam by 2.5-cm-long Comp B charge

**Exposures of image intensifier camera:** Two

**Time between exposures:** 61.98 μs    **Detonation velocity:** 2.84 km/s

**Notes:** ANFO is Gulf N-C-N 100 manufactured by Gulf Oil Chemical Co., Merriam, Kansas.

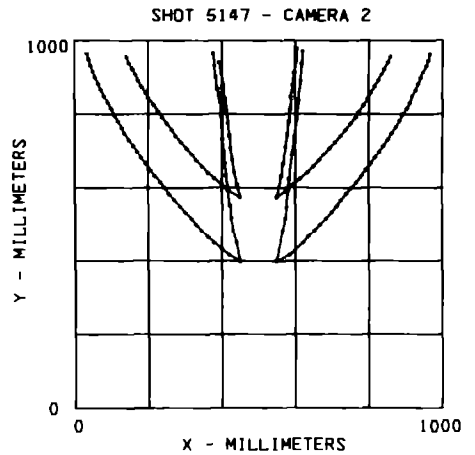
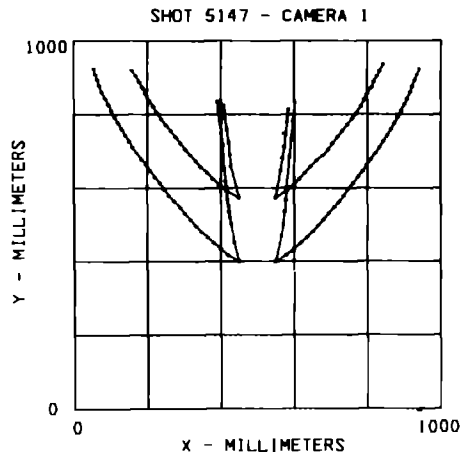

SHOT 5147 - Camera 1  
EXPLOSIVE (PIPE) - WATER INTERFACE POSITIONS

Exposure 1

Left			Right		
<u><i>n</i></u>	<u><i>x</i> (mm)</u>	<u><i>y</i> (mm)</u>	<u><i>n</i></u>	<u><i>x</i> (mm)</u>	<u><i>y</i> (mm)</u>
1	407.5	821.7	8	583.7	810.9
2	412.1	788.9	9	580.1	778.1
3	416.9	756.0	10	575.9	745.3
4	421.8	723.3	11	572.8	712.5
5	425.1	690.5	12	568.6	679.5
6	429.0	657.5	13	562.9	646.7
7	449.2	575.7	14	550.8	575.7

Exposure 2

Left			Right		
<u><i>n</i></u>	<u><i>x</i> (mm)</u>	<u><i>y</i> (mm)</u>	<u><i>n</i></u>	<u><i>x</i> (mm)</u>	<u><i>y</i> (mm)</u>
15	390.2	830.9	30	601.7	829.5
16	397.4	781.7	31	596.0	780.3
17	400.9	748.8	32	592.3	731.2
18	404.3	716.0	33	586.5	682.0
19	406.6	683.1	34	579.7	600.0
20	410.6	650.2	35	578.2	567.1
21	413.4	617.4	36	573.9	534.2
22	415.2	601.1	37	569.7	501.5
23	417.9	568.2	38	564.7	468.5
24	420.5	551.7	39	550.8	400.0
25	422.1	535.3			
26	424.8	519.0			
27	428.4	502.5			
28	436.4	449.5			
29	449.2	400.0			

AQUARIUM DATA

SHOCK FRONT POSITIONS

Exposure 1

Left			Right		
<i>n</i>	<i>x (mm)</i>	<i>y (mm)</i>	<i>n</i>	<i>x (mm)</i>	<i>y (mm)</i>
40	158.9	920.2	62	842.7	937.0
41	168.7	903.7	63	835.1	920.6
42	177.5	887.4	64	827.1	904.1
43	186.7	870.9	65	818.6	887.7
44	194.7	854.5	66	811.0	871.2
45	203.8	838.1	67	800.3	854.8
46	214.3	821.7	68	790.8	838.5
47	225.5	805.3	69	780.9	822.1
48	236.7	788.8	70	770.3	805.6
49	250.0	772.4	71	758.3	789.2
50	262.6	755.9	72	745.2	772.7
51	276.5	739.6	73	732.4	756.3
52	289.2	723.2	74	718.2	739.9
53	302.7	706.8	75	705.6	723.5
54	317.2	690.3	76	692.7	707.1
55	332.4	674.0	77	679.4	690.6
56	345.1	657.7	78	661.3	674.2
57	363.3	641.3	79	645.4	657.8
58	378.8	624.9	80	630.1	641.4
59	396.8	608.5	81	614.4	625.0
60	416.5	592.1	82	600.2	608.6
61	449.2	575.7	83	579.6	592.2
			84	550.8	575.7

Exposure 2

Left			Right		
<i>n</i>	<i>x (mm)</i>	<i>y (mm)</i>	<i>n</i>	<i>x (mm)</i>	<i>y (mm)</i>
85	54.5	925.4	118	941.4	923.8
86	59.0	909.0	119	935.8	907.4
87	64.4	892.5	120	930.2	891.0
88	70.7	876.1	121	923.1	874.7
89	77.0	859.7	122	916.4	858.4
90	85.3	843.4	123	908.4	842.2
91	94.0	826.9	124	900.7	825.9
92	101.3	810.5	125	892.3	809.4

AQUARIUM DATA

93	110.6	794.0	126	884.1	793.1
94	119.5	777.6	127	873.3	776.7
95	129.3	761.1	128	863.4	760.5
96	140.0	744.8	129	853.5	744.1
97	150.4	728.4	130	843.0	727.7
98	160.5	712.0	131	833.0	711.3
99	172.4	695.6	132	820.9	694.8
100	184.1	679.1	133	809.7	678.4
101	195.9	662.7	134	797.6	662.2
102	208.5	646.2	135	786.9	645.7
103	220.3	629.9	136	774.5	629.5
104	234.2	613.5	137	761.2	613.2
105	246.8	597.1	138	747.2	596.8
106	259.1	580.6	139	735.9	580.5
107	272.7	564.2	140	722.9	564.0
108	287.6	547.7	141	709.1	547.8
109	301.5	531.4	142	693.9	531.4
110	316.8	514.9	143	680.7	514.9
111	331.2	498.5	144	664.8	498.5
112	346.0	482.1	145	649.4	482.1
113	362.7	465.6	146	634.2	465.6
114	380.8	449.2	147	618.0	449.2
115	399.9	432.8	148	600.8	432.7
116	420.0	416.4	149	578.5	416.4
117	449.2	400.0	150	550.8	400.0

SHOT 5147 - Camera 2  
EXPLOSIVE (PIPE) - WATER INTERFACE POSITIONS

Exposure 1

<u>Left</u>			<u>Right</u>		
<u>n</u>	<u>x (mm)</u>	<u>y (mm)</u>	<u>n</u>	<u>x (mm)</u>	<u>y (mm)</u>
1	393.6	940.6	13	605.7	976.3
2	399.6	907.7	14	601.0	943.3
3	404.3	874.4	15	596.4	910.4
4	407.9	841.2	16	592.5	877.3
5	412.4	808.1	17	588.0	844.4
6	415.9	774.9	18	584.5	811.4
7	419.4	741.6	19	581.2	778.5
8	423.5	708.5	20	577.5	745.4

**AQUARIUM DATA**

9	428.0	675.4	21	573.5	712.5
10	434.1	642.1	22	566.3	663.1
11	442.3	608.9	23	562.0	630.0
12	449.2	575.7	24	550.8	575.7

**Exposure 2**

<u>Left</u>			<u>Right</u>		
<u>n</u>	<u>x (mm)</u>	<u>y (mm)</u>	<u>n</u>	<u>x (mm)</u>	<u>y (mm)</u>
25	375.9	963.9	42	620.8	969.6
26	379.9	930.8	43	618.0	936.5
27	383.5	897.7	44	614.3	886.7
28	388.6	864.4	45	608.7	837.0
29	394.4	831.2	46	603.0	787.2
30	397.4	798.1	47	596.8	737.4
31	399.9	764.8	48	590.2	687.6
32	401.8	731.6	49	583.8	621.3
33	404.4	698.5	50	579.9	588.2
34	408.2	665.2	51	575.1	544.9
35	411.6	632.1	52	571.2	513.5
36	415.9	599.0	53	565.4	481.7
37	421.9	549.3	54	550.8	400.0
38	424.6	516.1			
39	430.3	483.0			
40	439.9	449.8			
41	449.2	400.0			

**SHOCK FRONT POSITIONS**

**Exposure 1**

<u>Left</u>			<u>Right</u>		
<u>n</u>	<u>x (mm)</u>	<u>y (mm)</u>	<u>n</u>	<u>x (mm)</u>	<u>y (mm)</u>
55	139.9	956.7	79	859.6	955.9
56	146.9	940.2	80	851.9	939.4
57	156.4	923.7	81	843.2	923.0
58	164.4	907.2	82	835.4	906.6
59	171.3	890.7	83	826.2	890.1
60	181.5	874.1	84	816.9	873.5
61	192.7	857.5	85	806.9	857.0
62	201.9	840.9	86	796.1	840.4
63	212.6	824.3	87	785.5	823.9

AQUARIUM DATA

64	224.6	807.8	88	772.2	807.5
65	235.9	791.4	89	762.5	790.9
66	250.4	774.8	90	750.1	774.5
67	262.6	758.1	91	736.8	757.8
68	274.0	741.6	92	722.5	741.2
69	288.7	725.0	93	709.1	724.6
70	303.9	708.5	94	693.9	708.2
71	317.7	691.9	95	678.6	691.9
72	330.1	675.4	96	665.3	675.3
73	346.9	658.7	97	649.4	658.6
74	362.2	642.1	98	632.7	641.9
75	379.6	625.5	99	613.6	625.4
76	399.8	608.9	100	594.4	608.9
77	418.2	592.4	101	575.7	592.3
78	449.2	575.7	102	550.8	575.7

Exposure 2

Left			Right		
<i>n</i>	<i>x</i> (mm)	<i>y</i> (mm)	<i>n</i>	<i>x</i> (mm)	<i>y</i> (mm)
103	33.1	964.3	138	965.9	963.3
104	37.9	947.7	139	963.0	946.7
105	44.0	931.1	140	956.5	930.1
106	50.2	914.5	141	949.0	913.6
107	55.7	897.9	142	941.8	897.0
108	63.6	881.4	143	935.5	880.3
109	71.5	864.8	144	927.8	863.8
110	79.4	848.1	145	919.1	847.3
111	88.4	831.5	146	912.0	830.8
112	97.6	814.9	147	903.0	814.4
113	106.8	798.4	148	892.2	797.8
114	116.5	781.8	149	883.1	781.4
115	126.1	765.1	150	872.6	764.8
116	135.3	748.5	151	861.9	748.2
117	147.0	731.9	152	851.7	731.7
118	157.9	715.4	153	840.6	715.3
119	169.3	698.8	154	829.1	698.8
120	180.7	682.3	155	816.7	682.2
121	193.9	665.6	156	804.4	665.6
122	205.4	649.0	157	791.0	649.0
123	217.5	632.4	158	779.6	632.4

## AQUARIUM DATA

124	232.8	615.8	159	766.4	615.8
125	245.0	599.2	160	753.4	599.2
126	257.4	582.7	161	739.0	582.7
127	270.9	566.1	162	725.8	566.1
128	285.3	549.4	163	712.4	549.4
129	299.5	532.8	164	698.7	532.8
130	315.9	516.2	165	682.7	516.2
131	329.5	499.6	166	667.0	499.7
132	345.8	483.1	167	652.0	483.1
133	361.4	466.5	168	635.5	466.5
134	378.7	449.9	169	622.2	449.9
135	399.3	433.3	170	585.7	416.6
136	419.9	416.7	171	550.8	400.0
137	449.2	400.0			

AQUARIUM DATA

**Material:** ANFO    **Shot no.:** C-4688

**Experimenter:** G. F. Lederman    **Date:** March 29, 1977

**Charge diameter:** 9.99 cm    **Charge length:** 166.37 cm

**Initial density:** 0.787 g/cm<sup>3</sup>    **Temperature:** 348 K

**Confinement:** Clay pipe, 2.24-cm wall with 24.45-cm o.d., in water

**Booster:** One SE-1 detonator, one tetryl pellet, and one 20.32-cm-diam by 2.5-cm-long TNT charge

**Exposures of image intensifier camera:** Two

**Time between exposures:** 128.15  $\mu$ s    **Detonation velocity:** 3.78 km/s

**Notes:** ANFO is Gulf N-C-N 100 manufactured by Gulf Oil Chemical Co., Merriam, Kansas.

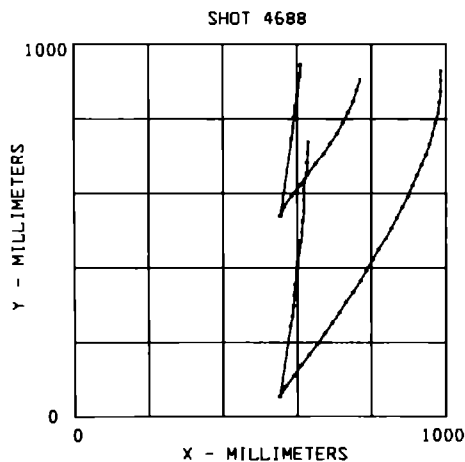



AQUARIUM DATA

SHOT 4688  
EXPLOSIVE (PIPE) - WATER INTERFACE POSITIONS

Exposure 1

Right		
<i>n</i>	<i>x</i> (mm)	<i>y</i> (mm)
1	610.1	944.9
2	607.5	916.6
3	604.1	888.4
4	600.2	860.3
5	595.1	832.1
6	591.8	803.9
7	588.2	775.7
8	585.7	747.5
9	554.4	539.6

Exposure 2

Right		
<i>n</i>	<i>x</i> (mm)	<i>y</i> (mm)
10	629.9	736.3
11	628.2	708.0
12	627.4	679.8
13	626.0	652.4
14	618.1	626.7
15	618.4	608.9
16	617.5	580.7
17	618.3	552.5
18	615.8	524.4
19	612.6	496.2
20	609.2	468.0
21	605.0	439.8
22	601.9	411.6
23	598.5	383.5
24	595.6	355.2
25	592.4	327.0
26	589.3	298.9
27	586.4	270.7
28	582.0	242.4
29	553.1	55.7

## SHOCK FRONT POSITIONS

## Exposure 1

Right		
<i>n</i>	<i>x</i> (mm)	<i>y</i> (mm)
30	769.9	903.2
31	760.8	875.0
32	751.0	846.9
33	738.8	818.7
34	723.9	790.5
35	707.8	762.3
36	689.6	734.2
37	670.9	706.0
38	649.7	677.7
39	628.9	649.6
40	608.1	621.4
41	585.7	593.2
42	564.9	565.0
43	554.4	539.6

## Exposure 2

Right		
<i>n</i>	<i>x</i> (mm)	<i>y</i> (mm)
44	986.7	929.4
45	987.3	901.2
46	986.8	873.0
47	984.0	844.9
48	979.7	816.7
49	972.3	788.4
50	964.9	760.3
51	956.0	732.1
52	946.5	703.9
53	934.6	675.7
54	923.5	647.6
55	910.5	619.4
56	897.8	591.2
57	883.3	563.0
58	868.3	534.8
59	853.0	506.6
60	838.0	478.4

## AQUARIUM DATA

61	820.6	450.2
62	804.0	422.1
63	786.6	393.9
64	769.7	365.7
65	751.2	337.5
66	732.3	309.3
67	712.9	281.1
68	695.0	253.0
69	674.5	224.7
70	654.4	196.6
71	633.1	168.4
72	611.3	140.2
73	591.4	112.0
74	569.3	83.9
75	553.1	55.7

AQUARIUM DATA

Material: ANFO Shot no.: C-4678

Experimenters: B. G. Craig and G. F. Lederman Date: March 9, 1977

Charge diameter: 10.16 cm Charge length: 121.5 cm

Initial density: 0.793 g/cm<sup>3</sup> Temperature: 298 K

Confinement: Clay pipe, 16.7-mm-wall, in water

Booster: One SE-1 detonator, one tetryl pellet, and an 11.43-cm-diam by 2.5-cm-long TNT charge

Exposures of image intensifier camera: Two

Time between exposures: 131.01  $\mu$ s Detonation velocity: 3.267 km/s

Notes: ANFO is Gulf N-C-N 100 manufactured by Gulf Oil Chemical Co., Merriam, Kansas.

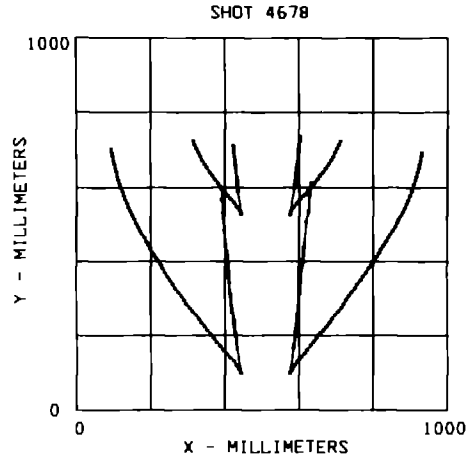

AQUARIUM DATA

SHOT 4678  
EXPLOSIVE (PIPE) - WATER INTERFACE POSITIONS

Exposure 1

Left			Right		
<i>n</i>	<i>x</i> (mm)	<i>y</i> (mm)	<i>n</i>	<i>x</i> (mm)	<i>y</i> (mm)
1	422.7	710.7	15	604.7	732.7
2	424.3	700.4	16	603.5	722.4
3	425.6	690.0	17	601.1	711.9
4	426.7	679.6	18	599.5	701.6
5	427.9	669.2	19	598.3	691.2
6	428.9	658.7	20	597.2	680.8
7	429.8	648.3	21	595.9	670.3
8	430.7	637.9	22	594.6	659.9
9	431.7	627.5	23	593.7	649.5
10	432.9	617.1	24	592.0	639.1
11	434.0	606.8	25	590.3	628.7
12	434.9	596.3	26	589.3	618.3
13	435.4	585.9	27	587.9	607.9
14	444.0	528.0	28	586.5	597.5
			29	575.0	528.0

Exposure 2

Left			Right		
<i>n</i>	<i>x</i> (mm)	<i>y</i> (mm)	<i>n</i>	<i>x</i> (mm)	<i>y</i> (mm)
30	392.3	594.6	60	633.2	610.4
31	392.0	567.2	61	628.5	576.3
32	394.0	532.3	62	625.6	535.0
33	398.5	485.3	63	620.8	506.1
34	405.0	425.8	64	614.6	446.3
35	406.3	415.3	65	613.3	435.9
36	406.9	404.9	66	612.2	425.5
37	407.5	394.5	67	611.2	415.0
38	408.7	384.1	68	609.8	404.6
39	410.1	373.7	69	609.7	394.2
40	411.1	363.3	70	608.7	383.9
41	412.2	352.9	71	606.8	373.5
42	412.8	342.5	72	605.8	363.0
43	414.1	321.7	73	605.2	352.6
44	415.2	311.2	74	604.4	342.2

AQUARIUM DATA

45	415.9	300.9	75	603.6	331.8
46	416.7	290.5	76	602.9	321.4
47	418.2	280.1	77	601.9	310.9
48	419.3	269.7	78	600.6	300.6
49	420.7	259.2	79	599.9	290.2
50	422.8	248.8	80	598.9	279.8
51	424.4	238.4	81	597.7	269.4
52	425.1	228.0	82	596.6	258.9
53	426.0	218.6	83	595.6	248.5
54	428.9	207.2	84	594.2	238.1
55	430.1	196.8	85	593.1	227.7
56	431.3	186.4	86	591.6	217.3
57	432.3	176.0	87	590.4	207.0
58	433.4	165.5	88	589.3	196.5
59	444.0	100.0	89	588.0	186.1
			90	586.5	175.7
			91	585.2	165.2
			92	575.0	100.0

SHOCK FRONT POSITIONS

Exposure 1

<u>Left</u>			<u>Right</u>		
<u>n</u>	<u>x (mm)</u>	<u>y (mm)</u>	<u>n</u>	<u>x (mm)</u>	<u>y (mm)</u>
93	314.6	725.7	113	712.6	725.7
94	318.8	715.3	114	708.1	715.3
95	323.3	705.0	115	703.9	704.9
96	328.3	694.6	116	698.8	694.5
97	333.8	684.2	117	692.5	684.1
98	339.0	673.8	118	686.1	673.7
99	345.4	663.3	119	679.8	663.3
100	352.0	652.9	120	672.5	652.9
101	358.7	642.5	121	665.1	642.4
102	366.0	632.1	122	657.4	632.0
103	373.5	621.7	123	649.6	621.7
104	381.7	611.3	124	641.2	611.2
105	389.8	600.9	125	631.8	600.9
106	398.1	590.5	126	622.8	590.5
107	406.4	580.1	127	613.6	580.0
108	415.5	569.7	128	603.8	569.6

AQUARIUM DATA

109	424.7	559.2	129	594.6	559.2
110	432.4	548.8	130	584.6	548.8
111	439.4	538.5	131	579.0	538.4
112	444.0	528.0	132	575.0	528.0

Exposure 2

Left			Right		
<i>n</i>	<i>x</i> (mm)	<i>y</i> (mm)	<i>n</i>	<i>x</i> (mm)	<i>y</i> (mm)
133	95.4	703.5	192	932.0	693.3
134	96.8	693.1	193	930.2	682.8
135	98.5	682.7	194	928.1	672.4
136	100.6	672.3	195	925.6	662.0
137	102.6	661.9	196	922.9	651.6
138	104.8	651.5	197	920.0	641.2
139	107.7	641.1	198	917.1	630.8
140	110.8	630.6	199	913.8	620.4
141	114.1	620.3	200	910.6	610.0
142	117.0	609.9	201	906.6	599.6
143	120.3	599.5	202	902.6	589.2
144	124.4	589.1	203	898.6	578.8
145	128.1	578.6	204	894.3	568.3
146	132.2	568.2	205	889.5	557.9
147	136.1	557.8	206	885.1	547.5
148	140.8	547.4	207	880.4	537.2
149	145.4	537.0	208	875.5	526.8
150	150.8	526.6	209	870.5	516.4
151	156.2	516.2	210	865.0	505.9
152	160.9	505.8	211	859.2	495.5
153	166.0	495.4	212	853.8	485.1
154	170.9	484.9	213	847.2	474.6
155	177.0	474.5	214	841.7	464.3
156	182.6	464.2	215	835.5	453.9
157	188.0	453.8	216	828.8	443.5
158	194.2	443.4	217	822.4	433.1
159	200.7	433.0	218	816.0	422.7
160	206.9	422.5	219	808.2	412.2
161	213.4	412.1	220	802.4	401.8
162	219.8	401.7	221	795.3	391.4
163	226.5	391.3	222	788.0	381.1
164	233.0	380.9	223	781.5	370.6

AQUARIUM DATA

165	239.5	370.5	224	773.9	360.2
166	245.9	360.1	225	766.1	349.8
167	253.1	349.7	226	758.4	339.4
168	260.1	339.3	227	751.1	329.0
169	267.4	328.8	228	743.3	318.6
170	275.2	318.4	229	735.4	308.2
171	282.7	308.0	230	728.2	297.8
172	290.4	297.7	231	721.5	287.4
173	296.5	287.3	232	714.3	277.0
174	304.9	276.9	233	706.3	266.6
175	313.1	266.4	234	698.2	256.1
176	321.4	256.0	235	690.5	245.7
177	329.2	245.6	236	682.8	235.3
178	336.6	235.1	237	674.3	224.9
179	344.4	224.8	238	666.0	214.5
180	352.4	214.4	239	657.0	204.2
181	361.0	204.0	240	648.9	193.8
182	369.3	193.6	241	640.0	183.3
183	377.3	183.2	242	631.9	172.9
184	385.9	172.8	243	622.4	162.5
185	395.2	162.3	244	614.2	152.0
186	404.5	151.9	245	604.3	141.7
187	413.6	141.5	246	594.5	131.3
188	424.7	131.1	247	587.9	120.9
189	431.9	120.7	248	581.4	110.5
190	438.4	110.3	249	575.0	100.0
191	440.0	100.0			



**AQUARIUM DATA**

**Material:** ANFO      **Shot no.:** C-5058

**Experimenter:** S. Goldstein      **Date:** September 11, 1980

**Charge diameter:** 10 cm      **Charge length:** 15.2 cm

**Initial density:** 0.80 g/cm<sup>3</sup>      **Temperature:** 295 K

**Confinement:** 1.6-cm clay pipe in water

**Booster:** One 1E23 detonator, one P-040 lens, and two 10.2-cm-diam by 1.3-cm-long Comp B charges

**Exposures of image intensifier camera:** Two

**Time between exposures:** 87.07  $\mu$ s      **Detonation velocity:** 3.33 km/s

**Notes:** ANFO is Gulf N-C-N 100 manufactured by Gulf Oil Chemical Co., Merriam, Kansas.

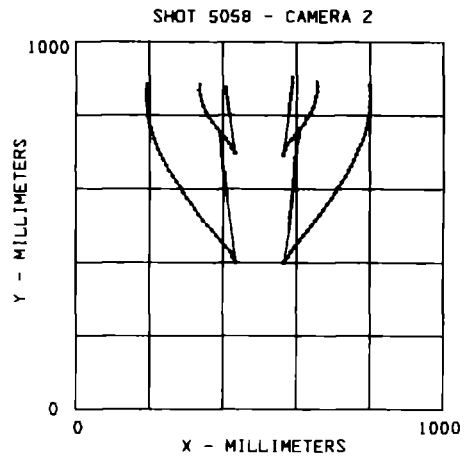
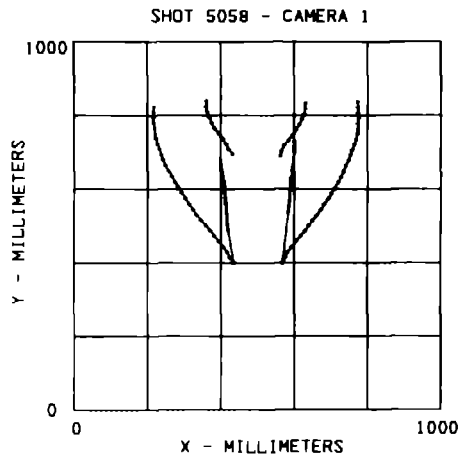

SHOT 5058 - Camera 1  
EXPLOSIVE (PIPE) - WATER INTERFACE POSITIONS

Exposure 2

Left			Right		
<i>n</i>	<i>x</i> (mm)	<i>y</i> (mm)	<i>n</i>	<i>x</i> (mm)	<i>y</i> (mm)
1	400.3	677.4	16	602.4	726.6
2	401.4	662.8	17	601.4	712.1
3	402.9	648.1	18	601.3	697.6
4	404.8	633.5	19	590.2	624.4
5	407.5	618.8	20	590.6	609.9
6	409.2	604.2	21	589.0	595.3
7	410.5	589.6	22	587.8	580.8
8	412.2	575.0	23	587.0	566.3
9	413.5	560.4	24	585.5	551.7
10	414.4	545.8	25	584.0	537.1
11	416.0	531.1	26	567.5	400.0
12	416.9	516.5			
13	418.2	501.9			
14	420.5	487.4			
15	435.8	400.0			

SHOCK FRONT POSITIONS

Exposure 1

Left			Right		
<i>n</i>	<i>x</i> (mm)	<i>y</i> (mm)	<i>n</i>	<i>x</i> (mm)	<i>y</i> (mm)
27	361.1	838.7	38	631.1	832.6
28	360.8	824.1	39	630.0	818.1
29	362.9	809.6	40	628.0	803.7
30	367.8	795.1	41	622.0	789.2
31	374.8	780.4	42	615.0	774.7
32	383.2	765.8	43	605.1	760.1
33	394.7	751.2	44	594.8	745.6
34	406.9	736.5	45	585.4	731.1
35	415.3	721.9	46	573.4	716.5
36	421.8	707.3	47	567.2	702.1
37	432.7	692.7	48	564.0	687.6

AQUARIUM DATA

Exposure 2

Left			Right		
<i>n</i>	<i>x</i> (mm)	<i>y</i> (mm)	<i>n</i>	<i>x</i> (mm)	<i>y</i> (mm)
49	217.9	823.7	79	773.9	836.3
50	217.0	809.1	80	774.9	821.8
51	216.8	794.6	81	775.6	807.3
52	218.1	779.9	82	776.0	792.9
53	219.5	765.3	83	775.8	778.3
54	221.6	750.6	84	774.2	763.7
55	224.5	736.0	85	772.7	749.2
56	228.3	721.3	86	769.6	734.6
57	233.7	706.8	87	765.4	720.1
58	238.2	692.2	88	760.7	705.7
59	244.0	677.6	89	754.8	691.2
60	250.5	663.0	90	749.2	676.6
61	258.0	648.3	91	741.6	662.1
62	266.5	633.7	92	734.4	647.5
63	274.6	619.1	93	728.4	632.8
64	283.2	604.4	94	720.0	618.2
65	293.2	589.9	95	711.2	603.6
66	303.2	575.3	96	701.8	589.0
67	312.5	560.7	97	693.9	574.5
68	323.6	546.1	98	681.8	559.8
69	333.8	531.5	99	672.6	545.3
70	346.6	516.9	100	661.6	530.6
71	357.7	502.3	101	650.4	516.1
72	369.5	487.6	102	640.0	501.6
73	381.8	473.1	103	629.9	487.1
74	394.7	458.6	104	618.3	472.6
75	407.3	443.9	105	605.2	458.2
76	417.0	429.3	106	593.1	443.6
77	425.3	414.7	107	582.4	429.1
78	435.8	400.0	108	574.5	414.6
			109	567.5	400.0

SHOT 5058 - Camera 2  
EXPLOSIVE (PIPE) - WATER INTERFACE POSITIONS

Exposure 1

Left			Right		
<i>n</i>	<i>x</i> (mm)	<i>y</i> (mm)	<i>n</i>	<i>x</i> (mm)	<i>y</i> (mm)
1	407.7	873.8	8	589.0	901.9
2	409.0	859.2	9	587.5	887.4
3	411.3	844.6	10	586.2	872.8
4	414.1	830.0	11	585.0	858.2
5	415.6	815.4	12	583.5	843.6
6	418.9	800.8	13	580.4	829.0
7	432.7	694.2	14	579.6	814.4
			15	564.7	690.6

Exposure 2

Left			Right		
<i>n</i>	<i>x</i> (mm)	<i>y</i> (mm)	<i>n</i>	<i>x</i> (mm)	<i>y</i> (mm)
16	393.4	743.0	29	607.0	754.6
17	394.7	728.5	30	606.8	740.0
18	396.4	713.9	31	603.7	725.4
19	397.4	699.2	32	600.7	710.8
20	398.9	684.8	33	599.2	696.3
21	400.0	670.2	34	597.1	681.8
22	402.1	655.6	35	595.9	667.2
23	403.6	641.1	36	594.6	652.7
24	405.8	626.5	37	593.6	638.1
25	407.1	611.9	38	592.3	623.5
26	408.7	597.3	39	591.3	608.9
27	410.6	582.7	40	589.7	594.3
28	435.2	400.0	41	588.6	579.8
			42	586.9	565.3
			43	584.6	550.7
			44	583.4	536.1
			45	582.2	521.5
			46	581.4	506.9
			47	580.2	492.3
			48	567.4	400.0

AQUARIUM DATA

SHOCK FRONT POSITIONS

Exposure 1

Left			Right		
<i>n</i>	<i>x</i> (mm)	<i>y</i> (mm)	<i>n</i>	<i>x</i> (mm)	<i>y</i> (mm)
49	335.9	883.7	63	655.5	889.7
50	335.8	869.1	64	656.1	880.2
51	337.8	854.5	65	656.0	865.6
52	341.0	839.9	66	653.9	851.0
53	346.5	825.3	67	649.9	836.3
54	353.0	810.8	68	644.9	821.7
55	360.9	796.3	69	637.7	807.2
56	371.0	781.7	70	629.1	792.6
57	382.5	767.2	71	620.9	778.1
58	393.5	752.6	72	609.1	763.5
59	406.0	738.0	73	598.6	749.0
60	416.9	723.4	74	586.4	734.3
61	425.8	708.8	75	574.6	719.7
62	432.7	694.2	76	570.7	705.2
			77	564.7	690.6

Exposure 2

Left			Right		
<i>n</i>	<i>x</i> (mm)	<i>y</i> (mm)	<i>n</i>	<i>x</i> (mm)	<i>y</i> (mm)
78	192.9	883.3	112	798.3	880.9
79	192.4	868.6	113	800.9	866.3
80	191.6	853.9	114	801.5	851.7
81	191.3	839.3	115	800.7	837.1
82	192.6	824.6	116	800.3	822.6
83	194.4	810.0	117	800.0	808.0
84	195.9	795.3	118	796.8	793.4
85	199.2	780.7	119	793.8	778.8
86	202.9	766.1	120	790.3	764.3
87	207.8	751.4	121	786.6	749.7
88	212.9	736.8	122	781.4	735.1
89	217.8	722.1	123	776.1	720.5
90	224.0	707.4	124	770.8	705.9
91	230.8	692.7	125	763.8	691.4
92	238.7	678.1	126	756.7	676.8
93	245.9	663.5	127	749.3	662.3

AQUARIUM DATA

94	254.1	648.8	128	741.0	647.8
95	262.6	634.1	129	732.7	633.1
96	271.1	619.5	130	723.8	618.6
97	282.5	604.8	131	713.9	603.9
98	291.1	590.2	132	705.2	589.3
99	301.5	575.6	133	694.4	574.9
100	312.8	560.9	134	683.5	560.3
101	322.6	546.2	135	674.0	545.8
102	333.3	531.6	136	663.2	531.2
103	345.0	516.9	137	651.7	516.6
104	357.1	502.3	138	641.3	502.0
105	369.5	487.7	139	630.5	487.4
106	381.1	473.0	140	618.1	472.9
107	393.7	458.3	141	606.9	458.3
108	407.1	443.8	142	595.1	443.8
109	419.2	429.2	143	585.3	429.2
110	427.3	414.6	144	576.0	414.7
111	435.2	400.0	145	567.4	400.0

**AQUARIUM DATA**

**Material:** ANFO      **Shot no.:** C-4700

**Experimenters:** G. F. Lederman and B. G. Craig      **Date:** May 17, 1977

**Charge diameter:** 19.88 cm      **Charge length:** 166.7 cm

**Initial density:** 0.896 g/cm<sup>3</sup>      **Temperature:** 298 K

**Confinement:** Clay pipe, 2.23-cm wall with 24.34-cm o.d., in water

**Booster:** One SE-1 detonator, one tetryl pellet, and a 2.5-cm-diam by 20.3-cm-long TNT charge

**Exposures of image intensifier camera:** Two

**Time between exposures:** 125.0  $\mu$ s      **Detonation velocity:** 4.15 km/s

**Notes:** ANFO is Gulf N-C-N 100 manufactured by Gulf Oil Chemical Co., Merriam, Kansas

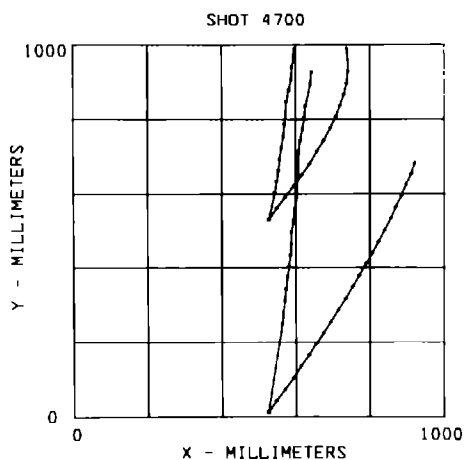

SHOT 4700  
EXPLOSIVE (PIPE) - WATER INTERFACE POSITIONS

Exposure 1

<u>Right</u>		
<u><i>n</i></u>	<u><i>x</i> (mm)</u>	<u><i>y</i> (mm)</u>
1	597.6	986.9
2	595.4	970.2
3	589.8	939.6
4	587.7	909.0
5	581.0	878.2
6	575.6	847.5
7	572.6	816.8
8	570.2	786.2
9	566.7	755.5
10	561.7	724.8
11	557.4	694.1
12	553.2	663.5
13	548.0	632.6
14	542.5	601.8
15	527.2	530.5

Exposure 2

<u>Right</u>		
<u><i>n</i></u>	<u><i>x</i> (mm)</u>	<u><i>y</i> (mm)</u>
16	643.4	926.3
17	640.8	895.6
18	626.5	834.0
19	622.5	803.5
20	617.9	772.6
21	612.0	741.9
22	608.8	711.1
23	606.6	649.6
24	603.1	618.8
25	601.2	587.9
26	596.6	557.3
27	594.1	526.7
28	589.0	495.9
29	587.9	465.2
30	585.4	434.6



## AQUARIUM DATA

31	581.0	404.0
32	576.7	373.1
33	574.0	342.3
34	570.6	311.7
35	566.0	280.8
36	564.0	250.0
37	525.2	11.7

## SHOCK FRONT POSITIONS

### Exposure 1

#### Right

<u><i>n</i></u>	<u><i>x (mm)</i></u>	<u><i>y (mm)</i></u>
38	739.1	990.8
39	741.8	960.1
40	742.0	929.5
41	738.4	898.8
42	730.7	868.1
43	720.7	837.3
44	708.2	806.6
45	693.2	775.9
46	676.0	745.2
47	657.2	714.5
48	637.8	683.9
49	616.1	653.2
50	594.4	622.5
51	572.2	591.7
52	548.3	561.1
53	527.2	530.4

### Exposure 2

#### Right

<u><i>n</i></u>	<u><i>x (mm)</i></u>	<u><i>y (mm)</i></u>
54	921.3	685.4
55	910.9	657.5
56	898.1	626.6
57	885.4	595.7
58	870.3	565.0
59	856.5	534.2
60	840.0	503.3

## AQUARIUM DATA

61	823.8	472.5
62	807.3	441.8
63	789.3	411.0
64	771.1	380.1
65	753.1	349.4
66	734.5	318.8
67	715.6	288.1
68	694.7	257.3
69	675.1	226.7
70	655.3	196.0
71	634.9	165.4
72	613.9	134.6
73	592.8	104.0
74	569.8	73.4
75	546.4	42.7
76	525.2	11.7

**AQUARIUM DATA**

**Material:** ANFO      **Shot no.:** C-4652

**Experimenter:** B. G. Craig      **Date:** December 12, 1976

**Charge diameter:** 9.76 cm      **Charge length:** 89.6 cm

**Initial density:** 0.897 g/cm<sup>3</sup>      **Temperature:** 298 K

**Confinement:** Clay pipe, 16-mm-thick wall, in water

**Booster:** One SE-1 detonator, one 1.27-by1.27-cm pellet, and an 11.43-cm-diam by 2.5-cm-long TNT charge

**Exposures of image intensifier camera:** Two

**Time between exposures:** 63.15  $\mu$ s      **Detonation velocity:** 3.47 km/s

**Notes:** ANFO is Gulf N-C-N 100 manufactured by Gulf Oil Chemical Co., Merriam, Kansas

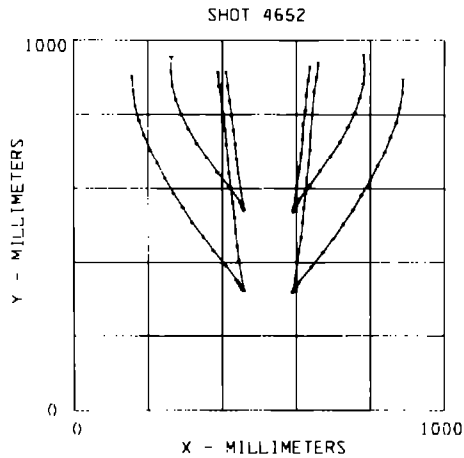

SHOT 4652  
EXPLOSIVE (PIPE) - WATER INTERFACE POSITIONS

Exposure 1

Left			Right		
<i>n</i>	<i>x</i> (mm)	<i>y</i> (mm)	<i>n</i>	<i>x</i> (mm)	<i>y</i> (mm)
1	411.1	914.4	10	637.4	928.7
2	415.6	875.1	11	631.3	889.3
3	420.8	835.8	12	626.8	850.1
4	424.7	796.6	13	624.2	810.8
5	429.7	757.3	14	619.0	771.5
6	434.6	718.0	15	616.5	732.2
7	438.6	678.7	16	612.5	693.0
8	443.5	639.5	17	608.3	653.6
9	458.4	543.5	18	592.3	539.3

Exposure 2

Left			Right		
<i>n</i>	<i>x</i> (mm)	<i>y</i> (mm)	<i>n</i>	<i>x</i> (mm)	<i>y</i> (mm)
19	388.5	914.1	34	660.6	939.1
20	391.8	874.8	35	654.2	899.9
21	397.9	835.6	36	648.7	860.7
22	403.4	796.4	37	638.4	743.0
23	408.0	757.2	38	636.5	703.9
24	411.3	718.0	39	633.4	664.7
25	415.5	678.7	40	628.9	625.5
26	418.5	639.4	41	625.8	586.2
27	422.8	600.1	42	620.7	547.0
28	428.5	560.9	43	617.2	507.7
29	432.5	521.6	44	612.8	468.5
30	436.4	482.5	45	607.2	429.1
31	440.8	443.2	46	591.1	321.4
32	444.5	404.1			
33	458.0	323.8			

## AQUARIUM DATA

## SHOCK FRONT POSITIONS

## Exposure 1

Left			Right		
<i>n</i>	<i>x</i> (mm)	<i>y</i> (mm)	<i>n</i>	<i>x</i> (mm)	<i>y</i> (mm)
47	263.1	957.4	63	782.4	962.3
48	261.3	918.3	64	784.6	925.1
49	265.8	879.1	65	780.9	883.8
50	274.4	839.9	66	771.6	844.5
51	289.2	800.7	67	757.6	805.3
52	309.0	761.5	68	740.6	766.0
53	331.6	722.3	69	718.5	726.7
54	358.3	683.1	70	692.0	687.5
55	386.8	643.9	71	664.6	648.2
56	417.6	604.7	72	636.3	608.9
57	447.8	565.5	73	606.5	569.6
58	450.9	561.2	74	601.9	561.8
59	452.9	556.5	75	599.7	557.3
60	455.4	552.1	76	597.2	553.0
61	456.7	547.4	77	595.1	548.8
62	458.3	542.9	78	593.4	544.6
			79	592.3	539.9

## Exposure 2

Left			Right		
<i>n</i>	<i>x</i> (mm)	<i>y</i> (mm)	<i>n</i>	<i>x</i> (mm)	<i>y</i> (mm)
80	157.3	902.7	102	888.9	896.8
81	159.4	863.5	103	886.0	857.6
82	165.1	824.1	104	879.3	818.4
83	174.4	784.9	105	869.2	779.1
84	188.6	745.6	106	855.5	739.8
85	204.4	706.4	107	839.6	700.6
86	224.2	668.0	108	820.2	661.4
87	245.2	628.0	109	800.1	622.2
88	268.8	588.6	110	777.3	582.8
89	293.0	549.4	111	752.9	543.7
90	318.3	510.2	112	727.4	504.4
91	347.7	470.9	113	699.7	465.3
92	376.6	431.6	114	671.3	426.1
93	409.2	392.4	115	639.2	386.8
94	438.8	353.0	116	606.7	347.5

**AQUARIUM DATA**

95	443.7	347.2	117	602.4	341.3
96	447.0	341.5	118	599.2	335.2
97	449.4	337.0	119	596.1	330.4
98	451.5	333.8	120	593.8	315.1
99	453.5	330.3	121	590.8	320.8
100	455.3	327.1			
101	457.7	323.7			

**AQUARIUM DATA**

**Material:** ANFO    **Shot no.:** C-4664

**Experimenter:** B. G. Craig    **Date:** January 26, 1977

**Charge diameter:** 19.8 cm    **Charge length:** 166 cm

**Initial density:** 0.901 g/cm<sup>3</sup>    **Temperature:** 297 K

**Confinement:** Clay pipe, 22-mm wall

**Booster:** One SE-1 detonator, one tetryl pellet, and a 20.32-cm-diam by 2.5-cm-long TNT charge

**Exposures of image intensifier camera:** Two

**Time between exposures:** 125.00  $\mu$ s    **Detonation velocity:** 4.12 km/s

**Notes:** ANFO is Gulf N-C-N 100 manufactured by Gulf Oil Chemical Co., Merriam, Kansas.

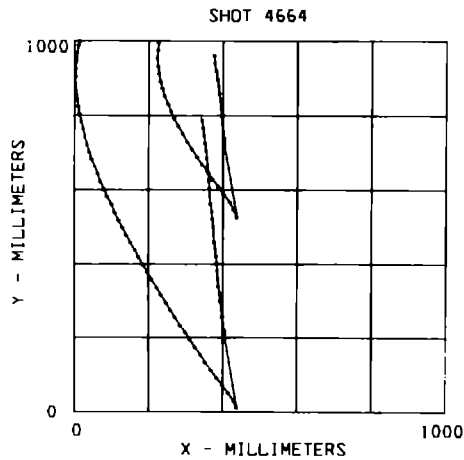

SHOT 4664  
EXPLOSIVE (PIPE) - WATER INTERFACE POSITIONS

Exposure 1

<u>Left</u>		
<u><i>n</i></u>	<u><i>x</i> (mm)</u>	<u><i>y</i> (mm)</u>
1	377.2	960.0
2	378.0	939.6
3	382.4	919.3
4	385.2	899.0
5	387.8	878.7
6	390.6	858.3
7	392.7	838.0
8	394.8	817.6
9	396.9	797.3
10	398.4	777.0
11	400.3	756.7
12	403.0	736.3
13	404.8	715.9
14	437.6	527.2

Exposure 2

<u>Left</u>		
<u><i>n</i></u>	<u><i>x</i> (mm)</u>	<u><i>y</i> (mm)</u>
15	343.9	786.1
16	347.1	765.8
17	349.3	745.4
18	352.0	725.0
19	354.2	704.7
20	356.7	684.4
21	358.7	664.1
22	360.5	643.7
23	362.3	623.4
24	363.6	603.1
25	365.0	582.8
26	366.9	562.4
27	369.2	542.0
28	371.2	521.7
29	373.2	501.4
30	375.1	481.1



## AQUARIUM DATA

31	377.1	460.7
32	379.9	440.4
33	382.0	420.0
34	383.9	399.7
35	385.3	379.4
36	386.8	359.1
37	388.9	338.7
38	391.5	318.4
39	393.7	298.1
40	396.6	277.7
41	398.1	257.4
42	401.0	237.0
43	404.3	216.7
44	406.0	196.4
45	438.1	12.1

## SHOCK FRONT POSITIONS

Exposure 1

Left

<u>n</u>	<u>x (mm)</u>	<u>y (mm)</u>
46	227.0	994.9
47	225.0	974.6
48	223.8	954.2
49	225.1	933.9
50	228.0	913.5
51	231.7	893.2
52	237.2	872.9
53	243.9	852.5
54	251.7	832.2
55	260.4	811.8
56	269.1	791.6
57	279.8	771.2
58	291.6	750.9
59	303.4	730.5
60	316.5	710.2
61	330.2	689.9
62	343.7	669.6
63	357.8	649.2
64	372.3	628.8

AQUARIUM DATA

65	387.6	608.5
66	402.0	588.2
67	418.1	567.9
68	429.7	547.5
69	437.6	527.2

Exposure 2

Left		
<u>n</u>	<u>x (mm)</u>	<u>y (mm)</u>
70	15.0	999.1
71	11.5	988.2
72	8.0	967.8
73	5.6	947.5
74	4.0	927.1
75	3.6	906.8
76	3.9	886.5
77	5.2	866.1
78	7.5	845.8
79	9.8	825.4
80	13.6	805.1
81	17.6	784.8
82	22.8	764.5
83	27.7	744.1
84	33.7	723.8
85	40.4	703.4
86	46.9	683.2
87	55.5	662.8
88	62.8	642.4
89	70.6	622.1
90	79.6	601.8
91	89.0	581.5
92	99.5	561.2
93	108.8	540.8
94	118.7	520.4
95	129.9	500.1
96	139.9	479.8
97	151.8	459.5
98	162.9	439.1
99	173.6	418.8
100	185.8	398.5

## AQUARIUM DATA

101	197.1	378.2
102	209.0	357.8
103	222.3	337.4
104	233.2	317.1
105	246.6	296.8
106	258.8	276.5
107	271.2	256.1
108	284.5	235.8
109	298.4	215.4
110	311.4	195.2
111	325.1	174.8
112	339.4	154.5
113	353.9	134.1
113	368.9	113.8
115	384.1	93.5
116	399.4	73.2
117	415.2	52.8
118	429.4	32.5
119	438.1	12.1

AQUARIUM DATA

**Material:** ANFO    **Shot no.:** C-4768

**Experimenter:** T. E. Gould    **Date:** April 5, 1978

**Charge diameter:** 9.76 cm    **Charge length:** 120.65 cm

**Initial density:** 0.931 g/cm<sup>3</sup>    **Temperature:** 299 K

**Confinement:** Clay pipe, 1.62-cm wall with 9.76-cm i.d., in water

**Booster:** One SE-1 detonator, one PBX-9407 pellet, and two 10.16-cm-diam by 1.27-cm-long TNT charges

**Exposures of image intensifier camera:** Two

**Time between exposures:** Camera 1, 58.86  $\mu$ s; Camera 2, 79.95  $\mu$ s

**Detonation velocity:** 3.65 km/s

**Notes:** ANFO is Gulf N-C-N 500 manufactured by Gulf Oil Chemical Co., Merriam, Kansas

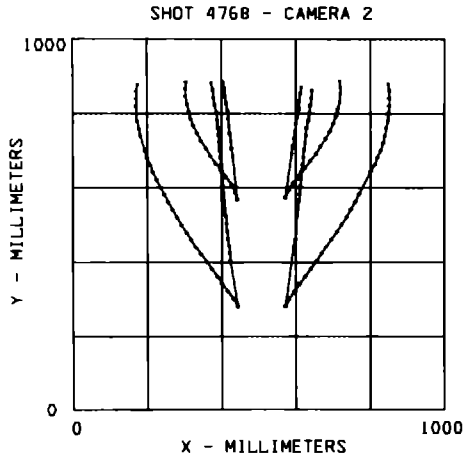
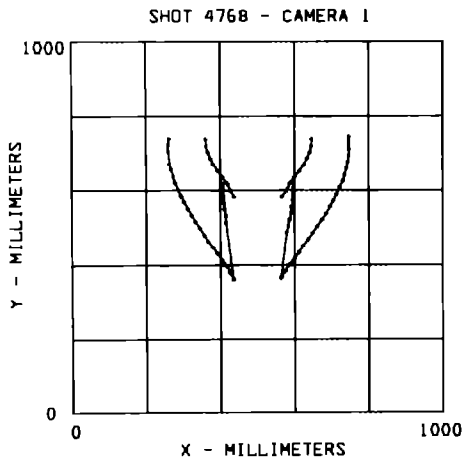

AQUARIUM DATA

SHOT 4768 - Camera 1  
EXPLOSIVE (PIPE) - WATER INTERFACE POSITIONS

Exposure 2

Left			Right		
<i>n</i>	<i>x</i> (mm)	<i>y</i> (mm)	<i>n</i>	<i>x</i> (mm)	<i>y</i> (mm)
1	406.4	617.1	9	598.7	624.7
2	407.0	599.9	10	597.9	607.4
3	408.6	582.8	11	596.3	590.2
4	409.9	565.6	12	594.2	572.9
5	412.0	548.4	13	591.6	555.7
6	414.5	531.2	14	590.2	538.6
7	415.4	514.1	15	587.1	521.5
8	434.2	362.1	16	583.2	504.3
			17	579.0	487.1
			18	563.7	367.1

SHOCK FRONT POSITIONS

Exposure 1

Left			Right		
<i>n</i>	<i>x</i> (mm)	<i>y</i> (mm)	<i>n</i>	<i>x</i> (mm)	<i>y</i> (mm)
19	360.6	738.0	29	646.3	737.6
20	361.9	720.8	30	645.4	720.5
21	365.9	703.6	31	641.8	703.3
22	372.9	686.5	32	634.1	686.2
23	382.0	669.4	33	624.2	669.1
24	392.8	652.3	34	613.1	652.0
25	405.8	635.2	35	600.7	634.8
26	419.0	618.0	36	587.4	617.6
27	427.0	600.8	37	577.7	600.5
28	436.4	583.7	38	565.4	583.4

Exposure 2

Left			Right		
<i>n</i>	<i>x</i> (mm)	<i>y</i> (mm)	<i>n</i>	<i>x</i> (mm)	<i>y</i> (mm)
39	261.9	740.5	62	745.9	745.4
40	260.7	723.2	63	747.4	728.1
41	260.5	705.9	64	746.9	711.0

AQUARIUM DATA

42	264.0	671.5	65	745.9	693.8
43	267.7	654.3	66	743.3	676.5
44	272.9	637.0	67	740.0	659.5
45	279.1	619.7	68	734.5	642.2
46	287.1	602.4	69	729.4	625.0
47	294.6	585.2	70	721.6	607.9
48	294.6	585.2	71	713.5	590.6
49	303.4	568.1	72	704.8	573.4
50	312.5	550.8	73	694.4	556.2
51	323.7	533.7	74	684.2	539.0
52	333.7	516.5	75	673.3	521.7
53	345.1	499.4	76	661.4	504.4
54	356.1	482.2	77	649.0	487.2
55	367.1	465.1	78	636.2	470.1
56	379.5	448.0	79	623.4	453.0
57	392.2	430.9	80	612.0	435.7
58	404.4	413.8	81	599.3	418.6
59	418.7	396.5	82	584.6	401.5
60	426.9	379.2	83	574.3	384.2
61	434.2	362.1	84	563.7	367.1

SHOT 4768 - Camera 2  
EXPLOSIVE (PIPE) - WATER INTERFACE POSITIONS

Exposure 1

Left			Right		
<u>n</u>	<u>x (mm)</u>	<u>y (mm)</u>	<u>n</u>	<u>x (mm)</u>	<u>y (mm)</u>
1	404.5	884.6	13	615.1	871.4
2	408.3	864.8	14	611.1	851.5
3	410.8	844.9	15	608.2	831.6
4	412.8	825.0	16	608.5	811.6
5	416.5	805.1	17	602.9	791.7
6	418.6	785.1	18	600.7	771.8
7	420.3	765.2	19	597.6	751.9
8	421.6	745.4	20	594.2	732.0
9	424.6	725.5	21	592.2	712.1
10	426.7	705.5	22	588.6	692.1
11	429.5	685.6	23	571.1	574.1
12	442.2	567.7			

AQUARIUM DATA

Exposure 2

Left			Right		
<i>n</i>	<i>x</i> (mm)	<i>y</i> (mm)	<i>n</i>	<i>x</i> (mm)	<i>y</i> (mm)
24	372.9	881.3	50	643.7	860.2
25	376.8	861.4	51	641.0	840.3
26	378.9	841.5	52	638.6	820.5
27	381.5	821.6	53	636.0	800.5
28	385.9	801.6	54	633.2	780.6
29	388.0	781.7	55	629.0	760.7
30	389.6	761.9	56	627.0	740.8
31	391.4	742.0	57	624.8	721.0
32	393.3	722.1	58	622.2	701.0
33	395.4	702.1	59	619.9	681.0
34	396.7	682.2	60	617.5	661.0
35	398.9	662.2	61	614.9	641.3
36	400.7	642.4	62	612.8	621.4
37	402.1	622.5	63	611.1	601.5
38	403.6	602.6	64	609.7	581.5
39	405.4	582.7	65	606.5	561.6
40	407.2	562.7	66	604.5	541.7
41	408.5	542.8	67	601.9	521.8
42	411.4	522.9	68	599.6	501.9
43	413.1	503.0	69	599.2	482.0
44	414.9	483.1	70	598.5	462.0
45	416.8	463.2	71	592.6	442.1
46	419.2	443.3	72	570.9	283.2
47	421.8	423.4			
48	423.8	403.6			
49	442.9	283.0			

SHOCK FRONT POSITIONS

Exposure 1

Left			Right		
<i>n</i>	<i>x</i> (mm)	<i>y</i> (mm)	<i>n</i>	<i>x</i> (mm)	<i>y</i> (mm)
73	305.7	886.3	90	717.8	889.4
74	303.8	866.5	91	719.3	872.8
75	303.6	846.6	92	720.8	852.9
76	306.7	826.7	93	718.2	833.0

AQUARIUM DATA

77	311.0	806.7	94	713.8	813.0
78	316.7	786.7	95	707.7	793.1
79	324.9	766.8	96	700.0	773.2
80	334.2	747.0	97	691.0	753.4
81	345.5	727.1	98	679.8	733.5
82	357.5	707.2	99	666.5	713.5
83	370.3	687.2	100	654.3	693.6
84	384.0	667.3	101	639.1	673.7
85	397.6	647.4	102	624.6	653.8
86	412.0	627.6	103	610.5	633.9
87	426.8	607.7	104	593.6	614.0
88	436.1	587.7	105	580.4	594.1
89	442.2	567.7	106	571.1	574.1

Exposure 2

Left			Right		
<i>n</i>	<i>x</i> (mm)	<i>y</i> (mm)	<i>n</i>	<i>x</i> (mm)	<i>y</i> (mm)
107	174.8	880.2	137	848.6	881.6
108	171.7	860.4	138	851.4	861.8
109	171.1	840.5	139	851.9	841.9
110	170.4	820.6	140	851.8	822.0
111	172.0	800.6	141	850.5	802.0
112	173.9	780.7	142	848.2	782.1
113	177.5	760.8	143	844.1	762.2
114	181.4	741.0	144	839.9	742.3
115	192.9	701.1	145	834.3	722.4
116	200.2	681.1	146	827.6	702.5
117	208.4	661.2	147	820.2	682.6
118	215.6	641.4	148	811.4	662.5
119	224.6	621.5	149	802.0	642.7
120	235.3	601.6	150	770.6	582.7
121	246.1	581.6	151	760.4	562.7
122	257.0	561.7	152	748.8	542.7
123	267.7	541.8	153	736.6	522.7
124	280.0	521.9	154	723.3	502.6
125	291.9	502.0	155	710.6	482.7
126	304.9	482.1	156	695.8	462.7
127	318.9	462.1	157	681.9	442.6
128	330.6	442.2	158	669.1	422.8
129	344.7	422.4	159	655.8	402.8



## AQUARIUM DATA

130	359.3	402.5	160	640.0	382.9
131	373.6	382.6	161	625.3	362.8
132	387.5	362.6	162	610.3	342.8
133	401.9	342.7	163	594.4	322.9
134	416.4	322.7	164	582.2	303.0
135	431.6	302.9	165	570.9	283.2
136	442.9	283.0			

AQUARIUM DATA

Material: ANFO Shot no.: C-4632

Experimenter: B. G. Craig Date: October 1, 1976

Charge diameter: 10.1 cm Charge length: 89.3 cm

Initial density: 0.954 g/cm<sup>3</sup> Temperature: 294 K

Confinement: 6.35-mm Plexiglas in water

Booster: One SE-1 detonator, one PBX-9407 pellet, and a 10.16-cm-diam by 2.54-cm-long TNT charge

Exposures of image intensifier camera: Three

Time between exposures: 53.0 and 46.3  $\mu$ s Detonation velocity: 3.33 km/s

Notes: ANFO is Gulf N-C-N 100 manufactured by Gulf Oil Chemical Co., Merriam, Kansas.

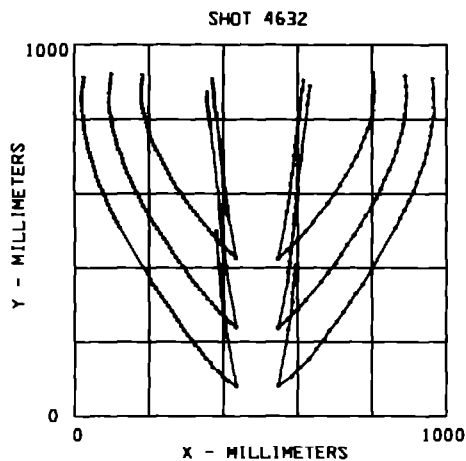

AQUARIUM DATA

SHOT 4632  
EXPLOSIVE (PIPE) - WATER INTERFACE POSITIONS

Exposure 1

Left			Right		
<u>n</u>	<u>x (mm)</u>	<u>y (mm)</u>	<u>n</u>	<u>x (mm)</u>	<u>y (mm)</u>
1	370.3	905.5	28	614.4	901.4
2	371.4	892.8	29	611.7	876.2
3	372.7	880.2	30	608.6	851.1
4	374.5	867.6	31	606.1	826.1
5	376.2	855.0	32	603.3	801.0
6	377.0	842.4	33	599.2	775.8
7	378.7	829.8	34	596.7	750.7
8	380.2	817.3	35	593.8	725.7
9	381.4	804.7	36	590.3	700.6
10	389.8	741.6	37	588.1	675.4
11	391.1	729.1	38	584.7	650.3
12	392.5	716.5	39	582.2	625.3
13	393.7	703.8	40	578.5	600.1
14	395.3	691.3	41	575.2	574.8
15	396.5	678.6	42	572.1	549.6
16	398.0	666.0	43	549.0	423.7
17	399.6	653.4			
18	401.0	640.8			
19	402.4	628.2			
20	403.9	615.7			
21	405.2	603.1			
22	406.6	590.5			
23	408.3	577.8			
24	409.7	565.2			
25	411.6	552.6			
26	413.3	540.0			
27	435.7	426.6			

Exposure 2

Left			Right		
<u>n</u>	<u>x (mm)</u>	<u>y (mm)</u>	<u>n</u>	<u>x (mm)</u>	<u>y (mm)</u>
44	356.3	869.6	67	633.6	889.1
45	356.1	857.1	68	630.7	863.9
46	357.4	844.4	69	626.8	838.5

AQUARIUM DATA

47	358.7	831.9	70	608.7	688.3
48	360.0	819.3	71	601.9	638.0
49	361.9	806.7	72	599.9	613.0
50	363.4	794.1	73	597.4	587.9
51	364.3	781.5	74	594.7	562.7
52	390.0	567.3	75	591.6	537.7
53	391.2	554.7	76	589.5	512.6
54	392.1	542.1	77	587.3	487.5
55	393.1	529.6	78	584.2	462.4
56	394.8	517.0	79	581.5	437.3
57	395.5	504.3	80	578.6	412.3
58	396.0	491.8	81	575.3	387.1
59	397.6	479.1	82	573.1	362.0
60	398.9	466.5	83	549.0	236.5
61	400.9	453.9			
62	402.3	441.3			
63	404.1	428.8			
64	405.7	416.2			
65	406.9	403.6			
66	435.7	239.7			

Exposure 3

Left			Right		
<u>n</u>	<u>x (mm)</u>	<u>y (mm)</u>	<u>n</u>	<u>x (mm)</u>	<u>y (mm)</u>
84	381.7	495.8	100	594.5	405.7
85	382.4	483.1	101	592.1	380.5
86	387.9	407.6	102	589.2	355.5
87	389.2	395.0	103	586.9	330.4
88	391.4	382.3	104	584.6	305.3
89	392.6	369.7	105	582.8	280.2
90	393.6	357.1	106	575.3	230.0
91	395.5	332.0	107	549.0	79.3
92	397.1	319.4			
93	398.4	306.8			
94	399.3	294.2			
95	401.2	281.6			
96	405.3	243.7			
97	407.2	231.2			
98	409.4	218.6			
99	435.7	79.9			

## AQUARIUM DATA

## SHOCK FRONT POSITIONS

## Exposure 1

Left			Right		
<i>n</i>	<i>x</i> (mm)	<i>y</i> (mm)	<i>n</i>	<i>x</i> (mm)	<i>y</i> (mm)
108	183.4	918.0	148	802.1	925.7
109	181.7	905.4	149	805.5	900.6
110	180.8	892.8	150	806.1	875.4
111	179.9	880.2	151	804.7	850.3
112	179.8	867.6	152	801.6	825.3
113	180.2	855.0	153	796.0	800.2
114	181.8	842.4	154	788.5	775.1
115	183.4	829.8	155	780.2	749.9
116	186.2	817.3	156	769.4	724.9
117	189.2	804.7	157	757.7	699.8
118	192.5	792.0	158	744.4	674.7
119	196.1	779.4	159	729.5	649.6
120	199.7	766.8	160	715.1	624.5
121	203.9	754.2	161	698.9	599.4
122	208.9	741.6	162	681.6	574.3
123	214.3	729.1	163	662.1	549.1
124	220.6	716.5	164	642.5	524.1
125	226.2	703.8	165	621.7	499.1
126	232.8	691.3	166	599.7	473.9
127	239.6	678.6	167	573.1	448.8
128	246.2	666.0	168	549.0	423.7
129	252.5	653.4			
130	260.2	640.8			
131	267.6	628.2			
132	275.8	615.7			
133	284.7	603.1			
134	293.7	590.5			
135	302.4	577.8			
136	311.7	565.2			
137	322.2	552.6			
138	330.4	540.0			
139	340.0	527.5			
140	350.3	514.9			
141	360.7	502.3			
142	370.4	489.7			

AQUARIUM DATA

143	381.5	477.1
144	393.9	464.4
145	406.3	451.8
146	421.8	439.3
147	435.7	426.6

Exposure 2

Left			Right		
<u>n</u>	<u>x (mm)</u>	<u>y (mm)</u>	<u>n</u>	<u>x (mm)</u>	<u>y (mm)</u>
169	100.4	920.1	224	888.3	914.2
170	97.4	907.5	225	891.0	889.1
171	95.7	894.9	226	892.5	864.0
172	94.9	882.3	227	891.6	838.8
173	93.6	869.6	228	889.1	813.8
174	93.9	857.0	229	885.8	788.7
175	93.7	844.4	230	880.5	763.6
176	94.3	831.8	231	873.6	738.5
177	95.7	819.3	232	865.3	713.4
178	98.4	806.7	233	856.5	688.3
179	100.3	794.1	234	846.4	663.2
180	102.2	781.5	235	835.3	638.1
181	105.1	768.8	236	824.0	613.0
182	108.1	756.3	237	811.0	587.9
183	111.3	743.6	238	797.5	562.8
184	114.7	731.1	239	782.6	537.7
185	119.1	718.5	240	768.4	512.7
186	123.3	705.9	241	751.8	487.5
187	127.7	693.3	242	733.5	462.4
188	132.4	680.6	243	717.7	437.4
189	137.2	668.4	244	701.3	412.3
190	142.4	655.5	245	681.7	387.2
191	148.3	642.8	246	663.9	362.0
192	154.5	630.3	247	644.1	337.0
193	159.6	617.7	248	622.1	311.9
194	165.7	605.1	249	600.4	286.8
195	172.8	592.5	250	575.0	261.6
196	178.9	579.8	251	549.0	236.5
197	185.6	567.3			
198	192.5	554.7			
199	199.7	542.1			

AQUARIUM DATA

200	207.0	529.5
201	215.3	516.9
202	221.9	504.3
203	230.6	491.8
204	239.3	479.1
205	248.1	466.5
206	256.0	453.8
207	263.9	441.3
208	273.2	428.7
209	282.2	416.1
210	291.7	403.5
211	299.7	390.9
212	309.0	378.3
213	318.1	365.6
214	327.9	353.0
215	338.6	340.5
216	348.0	327.9
217	358.6	315.4
218	368.5	302.7
219	380.5	290.1
220	392.4	277.5
221	404.8	264.9
222	420.2	252.3
223	435.7	239.7

Exposure 3

Left			Right		
<u>n</u>	<u>x (mm)</u>	<u>y (mm)</u>	<u>n</u>	<u>x (mm)</u>	<u>y (mm)</u>
252	24.4	911.5	309	961.9	907.6
253	22.8	898.9	310	965.1	882.5
254	21.8	887.0	311	965.8	857.3
255	19.8	873.6	312	965.9	832.3
256	19.6	861.1	313	964.4	807.2
257	19.9	848.4	314	960.8	782.1
258	20.9	835.9	315	957.9	757.0
259	20.9	823.3	316	952.5	731.9
260	22.5	810.8	317	945.6	706.9
261	22.8	798.1	318	939.8	681.7
262	24.7	785.5	319	930.5	656.6
263	27.0	772.9	320	922.1	631.5

AQUARIUM DATA

264	28.6	760.3	321	911.5	606.5
265	31.3	747.7	322	900.5	581.3
266	34.4	735.1	323	888.4	556.2
267	37.3	722.5	324	876.7	531.2
268	40.2	710.0	325	863.7	506.1
269	43.6	697.3	326	774.8	355.4
270	47.5	684.7	327	757.7	330.4
271	51.3	672.1	328	740.3	305.3
272	55.1	659.5	329	723.9	280.1
273	59.0	646.9	330	706.4	255.0
274	64.1	634.3	331	687.2	230.0
275	68.8	621.8	332	669.5	204.9
276	74.6	609.2	333	649.9	179.7
277	79.8	596.6	334	631.2	154.6
278	84.6	583.9	335	606.7	129.6
279	89.8	571.3	336	583.0	104.5
280	96.5	558.7	337	549.0	79.3
281	103.3	546.1			
282	108.7	533.5			
283	114.8	521.0			
284	120.8	508.4			
285	202.9	369.7			
286	210.8	357.1			
287	219.8	344.5			
288	226.4	332.0			
289	234.4	319.4			
290	243.0	306.8			
291	252.0	294.2			
292	261.8	281.6			
293	269.4	268.9			
294	278.5	256.4			
295	287.2	243.7			
296	295.3	231.2			
297	305.2	218.6			
298	314.8	206.0			
299	323.1	193.4			
300	335.1	180.8			
301	343.4	168.2			
302	354.0	155.5			
303	366.3	143.0			
304	374.0	130.4			



## AQUARIUM DATA

305	387.5	117.8
306	398.8	105.2
307	412.7	92.6
308	435.7	79.9

AQUARIUM DATA

Material: ANFO with distributed charge      Shot no.: C-4717

Experimenter: B. G. Craig      Date: August 18, 1977

Charge diameter: 10.5 cm      Charge length: 152.4 cm

Initial density: 0.797 g/cm<sup>3</sup>      Temperature: 297 K

Confinement: Pyrex tube, 0.26-cm wall with 11.02-cm o.d., 4.29-cm air; 2.37-cm clay, in water

Booster: One 1E23 detonator, one P-040 lens, and a 10.18-cm-diam by 2.44-cm-long TNT charge

Exposures of image intensifier camera: Two

Time between exposures: 140.68  $\mu$ s      Detonation velocity: 3.156 km/s

Notes: ANFO is Gulf N-C-N 100 manufactured by Gulf Oil Chemical Co., Merriam, Kansas

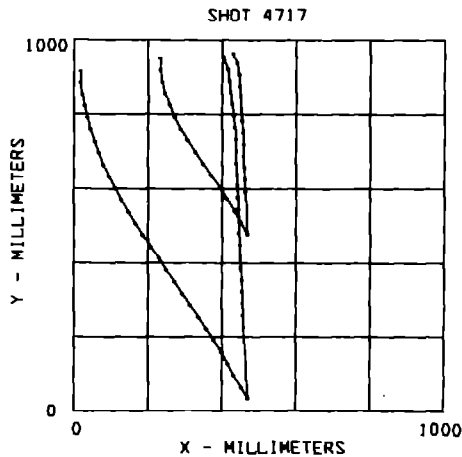

AQUARIUM DATA

SHOT 4717  
EXPLOSIVE (PIPE) - WATER INTERFACE POSITIONS

Exposure 1

Left		
<u>n</u>	<u>x (mm)</u>	<u>y (mm)</u>
1	429.4	961.8
2	439.2	938.8
3	445.9	907.2
4	447.9	875.8
5	449.6	844.3
6	452.3	812.6
7	455.0	781.1
8	456.6	749.6
9	457.7	718.1
10	459.1	686.5
11	460.8	654.9
12	462.2	623.5
13	463.0	591.9
14	470.0	478.1

Exposure 2

Left		
<u>n</u>	<u>x (mm)</u>	<u>y (mm)</u>
15	404.1	952.9
16	415.7	921.3
17	419.4	889.7
18	423.6	858.3
19	427.2	826.7
20	431.2	795.1
21	434.8	763.6
22	436.2	732.1
23	438.2	700.5
24	438.8	669.0
25	439.3	637.4
26	442.0	605.9
27	443.3	574.3
28	443.4	542.8

AQUARIUM DATA

29	446.0	511.3
30	446.7	479.7
31	448.0	448.2
32	449.7	416.6
33	451.6	385.1
34	453.8	353.6
35	455.2	322.0
36	455.9	290.4
37	456.7	259.0
38	458.1	227.5
39	469.5	34.2

SHOCK FRONT POSITIONS

Exposure 1

Left

<u>n</u>	<u>x (mm)</u>	<u>y (mm)</u>
40	232.8	951.3
41	233.5	919.8
42	238.1	888.2
43	246.2	856.8
44	257.9	825.2
45	272.0	793.6
46	288.7	762.1
47	306.2	730.6
48	328.7	699.0
49	350.8	667.5
50	370.8	636.0
51	394.2	604.4
52	413.9	572.8
53	432.6	541.3
54	452.4	509.8
55	470.0	478.2

Exposure 2

Left

<u>n</u>	<u>x (mm)</u>	<u>y (mm)</u>
56	17.8	917.4
57	18.2	885.9
58	23.3	854.4

## AQUARIUM DATA

59	28.2	822.8
60	36.3	791.2
61	45.3	759.7
62	54.8	728.2
63	67.6	696.6
64	80.3	665.1
65	95.0	633.6
66	111.0	602.0
67	128.6	570.4
68	147.0	538.9
69	167.3	507.4
70	187.4	475.9
71	207.4	444.3
72	229.6	412.7
73	250.7	381.2
74	272.3	349.7
75	294.1	318.1
76	314.7	286.5
77	337.4	255.1
78	357.9	223.6
79	378.9	191.9
80	398.0	160.3
81	414.6	128.9
82	431.7	97.4
83	452.0	65.8
84	469.5	34.2

AQUARIUM DATA

**Material:** ANFO with 7.5 wt% aluminum    **Shot no.:** C-4748

**Experimenter:** B. G. Craig    **Date:** January 10, 1978

**Charge diameter:** 3.838 cm    **Charge length:** 10.80 cm

**Initial density:** 1.100 g/cm<sup>3</sup>    **Temperature:** 297 K

**Confinement:** Red clay pipe, 10.16-cm-diam by 120.65-cm-long, in water

**Booster:** One SE-1 detonator, one PBX-9407 pellet, and a 2.54-cm-diam by 10.80-cm-long TNT charge

**Exposures of image intensifier camera:** Two

**Time between exposures:** 68.79  $\mu$ s    **Detonation velocity:** 3.75 km/s

**Notes:** ANFO is Gulf N-C-N 750 manufactured by Gulf Oil Chemical Co., Merriam, Kansas.

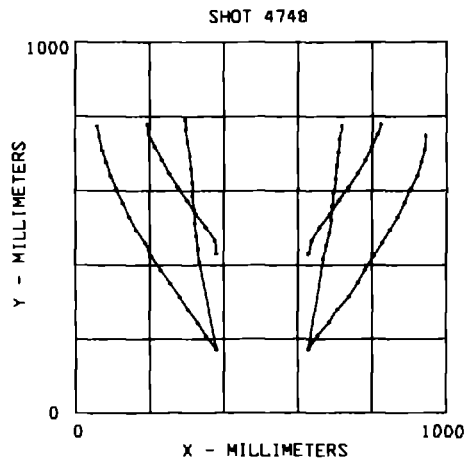

AQUARIUM DATA

SHOT 4748  
EXPLOSIVE (PIPE) - WATER INTERFACE POSITIONS

Exposure 2

Left			Right		
<i>n</i>	<i>x</i> (mm)	<i>y</i> (mm)	<i>n</i>	<i>x</i> (mm)	<i>y</i> (mm)
1	296.0	790.3	14	718.8	773.5
2	298.8	764.3	15	713.4	737.6
3	303.3	728.4	16	710.0	701.7
4	308.2	692.5	17	705.5	665.8
5	312.4	656.5	18	701.5	630.0
6	314.6	620.7	19	696.8	594.1
7	317.2	584.8	20	692.8	558.1
8	320.1	548.9	21	689.5	522.2
9	322.1	513.0	22	684.5	486.4
10	324.6	477.1	23	674.4	450.5
11	329.4	441.3	24	667.8	414.5
12	335.3	405.2	25	629.0	173.6
13	380.1	172.2			

SHOCK FRONT POSITIONS

Exposure 1

Left			Right		
<i>n</i>	<i>x</i> (mm)	<i>y</i> (mm)	<i>n</i>	<i>x</i> (mm)	<i>y</i> (mm)
26	193.7	778.3	37	822.5	778.0
27	198.8	754.1	38	817.0	754.1
28	214.6	718.1	39	799.7	718.2
29	233.7	682.2	40	784.1	682.2
30	251.5	646.3	41	761.8	646.3
31	275.2	610.5	42	737.4	610.6
32	301.0	574.6	43	712.2	574.6
33	324.9	538.6	44	685.9	538.6
34	352.1	502.7	45	657.8	502.7
35	375.4	466.9	46	636.4	466.9
36	380.1	430.9	47	629.0	431.0

AQUARIUM DATA

Exposure 2

Left			Right		
<i>n</i>	<i>x</i> (mm)	<i>y</i> (mm)	<i>n</i>	<i>x</i> (mm)	<i>y</i> (mm)
48	60.1	775.3	66	944.4	748.0
49	64.2	746.5	67	943.7	712.0
50	71.6	710.6	68	934.1	676.0
51	82.6	674.6	69	922.3	640.1
52	95.1	638.8	70	903.6	604.3
53	109.8	602.9	71	887.7	568.4
54	127.9	567.0	72	870.2	532.5
55	145.1	531.0	73	847.8	496.7
56	163.6	495.2	74	826.8	460.7
57	186.2	459.3	75	805.0	424.8
58	204.9	423.4	76	781.1	388.9
59	230.7	387.5	77	761.2	353.1
60	255.1	351.6	78	738.3	317.1
61	279.4	315.7	79	706.6	281.2
62	303.7	279.9	80	684.4	245.3
63	329.2	243.9	81	653.4	209.5
64	352.4	208.1	82	629.0	173.6
65	380.1	172.2			



**AQUARIUM DATA**

**Material:** ANFO with 7.5 wt% aluminum      **Shot no.:** C-4752

**Experimenters:** J. J. Dick and T. E. Gould      **Date:** February 14, 1978

**Charge diameter:** 19.66 cm      **Charge length:** 151.13 cm

**Initial density:** 1.11 g/cm<sup>3</sup>      **Temperature:** 291 K

**Confinement:** Brownish clay pipe, 2.33-cm wall with 24.32-cm o.d., in water

**Booster:** One SE-1 detonator, one PBX-9407 pellet, and a 20.32-cm-diam by 2.54-cm-long TNT charge

**Exposures of image intensifier camera:** Two

**Time between exposures:** 64.75  $\mu$ s      **Detonation velocity:** 4.24 km/s

**Notes:** ANFO is Gulf N-C-N 750 manufactured by Gulf Oil Chemical Co., Merriam, Kansas

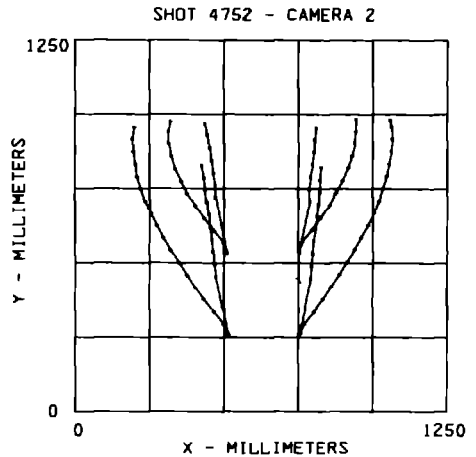
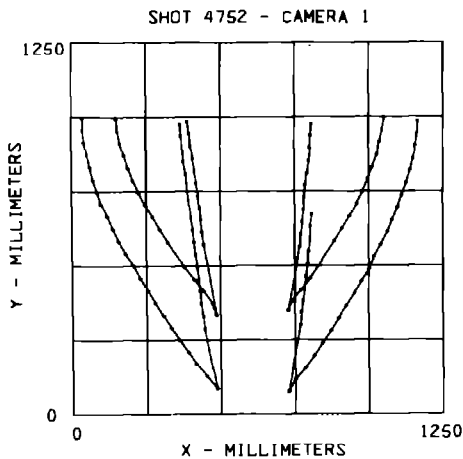

SHOT 4752 - Camera 1  
EXPLOSIVE (PIPE) - WATER INTERFACE POSITIONS

Exposure 1

Left			Right		
<i>n</i>	x (mm)	y (mm)	<i>n</i>	x (mm)	y (mm)
1	390.6	982.3	13	808.7	974.5
2	396.7	940.9	14	804.4	933.3
3	400.5	899.7	15	801.6	891.9
4	405.9	858.2	16	798.2	850.5
5	411.7	816.8	17	792.2	809.0
6	418.9	775.5	18	786.1	767.8
7	424.2	734.1	19	782.7	726.4
8	430.1	692.7	20	778.8	684.9
9	433.8	651.4	21	774.4	643.7
10	438.0	610.0	22	770.7	602.3
11	443.0	568.5	23	766.7	560.8
12	485.5	332.3	24	728.3	348.8

Exposure 2

Left			Right		
<i>n</i>	x (mm)	y (mm)	<i>n</i>	x (mm)	y (mm)
25	365.0	972.7	40	806.8	669.6
26	369.2	931.4	41	801.4	628.3
27	375.0	848.6	42	801.3	586.8
28	383.5	807.2	43	797.7	545.5
29	399.7	658.8	44	793.7	504.1
30	406.2	617.4	45	787.9	462.8
31	410.7	576.1	46	782.6	421.3
32	415.9	534.6	47	778.5	380.1
33	420.1	493.3	48	773.4	338.7
34	427.2	451.9	49	768.0	297.2
35	432.1	410.5	50	729.3	74.2
36	435.9	369.2			
37	442.4	327.8			
38	446.8	286.4			
39	488.3	85.0			

AQUARIUM DATA

SHOCK FRONT POSITIONS

Exposure 1

Left			Right		
<u>n</u>	<u>x (mm)</u>	<u>y (mm)</u>	<u>n</u>	<u>x (mm)</u>	<u>y (mm)</u>
51	149.9	992.9	68	1052.5	997.7
52	155.0	951.6	69	1045.7	956.1
53	163.2	910.3	70	1037.6	914.6
54	175.2	869.9	71	1026.7	873.2
55	189.7	827.4	72	1013.2	831.6
56	205.6	786.1	73	996.3	790.1
57	224.1	744.8	74	978.8	748.6
58	246.5	703.3	75	957.6	707.0
59	271.7	662.0	76	934.6	665.7
60	296.5	620.6	77	910.2	624.2
61	323.0	579.2	78	886.1	582.7
62	378.0	496.6	79	803.0	458.3
63	409.4	455.1	80	771.4	416.8
64	441.6	413.7	81	738.0	375.5
65	473.7	372.4	82	728.3	348.8
66	478.5	359.2			
67	485.5	332.3			

Exposure 2

Left			Right		
<u>n</u>	<u>x (mm)</u>	<u>y (mm)</u>	<u>n</u>	<u>x (mm)</u>	<u>y (mm)</u>
83	36.5	996.0	106	1167.7	985.6
84	37.8	954.6	107	1163.9	944.2
85	41.9	913.3	108	1158.2	903.0
86	49.9	871.9	109	1149.3	861.4
87	59.9	830.3	110	1139.0	820.0
88	71.1	789.0	111	1126.3	778.4
89	84.8	747.6	112	1112.0	736.9
90	100.3	706.1	113	1096.5	695.3
91	118.6	664.7	114	1079.5	653.9
92	136.5	623.4	115	1062.2	612.5
93	158.1	582.0	116	1041.0	571.0
94	181.8	540.6	117	1019.7	529.7
95	205.8	499.4	118	999.0	488.3
96	229.5	457.9	119	975.4	447.0

AQUARIUM DATA

97	253.9	416.5	120	951.6	405.4
98	278.9	375.0	121	924.9	364.0
99	306.5	333.6	122	898.6	322.6
100	332.9	292.0	123	872.7	281.1
101	360.9	250.6	124	844.3	239.8
102	391.1	209.3	125	817.2	198.5
103	419.6	167.8	126	787.9	157.0
104	452.9	126.5	127	753.0	115.8
105	488.3	85.0	128	729.3	74.2

SHOT 4752 - Camera 2  
EXPLOSIVE (PIPE) - WATER INTERFACE POSITIONS

Exposure 1

Left			Right		
<u>n</u>	<u>x (mm)</u>	<u>y (mm)</u>	<u>n</u>	<u>x (mm)</u>	<u>y (mm)</u>
1	436.9	966.6	9	811.0	952.6
2	446.2	925.1	10	806.0	911.3
3	452.5	883.8	11	802.7	869.9
4	457.9	842.3	12	797.5	828.4
5	464.4	800.8	13	792.7	786.9
6	469.8	759.4	14	788.2	745.5
7	472.6	717.9	15	786.9	703.9
8	511.0	533.0	16	753.9	536.4

Exposure 2

Left			Right		
<u>n</u>	<u>x (mm)</u>	<u>y (mm)</u>	<u>n</u>	<u>x (mm)</u>	<u>y (mm)</u>
17	425.8	825.6	28	827.1	819.5
18	433.0	784.2	29	823.3	788.1
19	438.1	742.8	30	822.4	736.7
20	441.8	701.3	31	817.2	695.2
21	449.9	659.8	32	811.9	653.7
22	454.9	618.4	33	807.7	612.4
23	460.1	577.0	34	803.1	570.9
24	464.2	535.5	35	798.8	529.4
25	469.6	494.1	36	793.4	488.0
26	473.3	452.7	37	790.8	446.5
27	513.9	257.4	38	756.7	262.1

AQUARIUM DATA

SHOCK FRONT POSITIONS

Exposure 1

Left			Right		
<u>n</u>	<u>x (mm)</u>	<u>y (mm)</u>	<u>n</u>	<u>x (mm)</u>	<u>y (mm)</u>
39	320.1	974.3	51	942.9	983.7
40	314.4	940.8	52	943.5	942.2
41	315.0	899.4	53	939.6	900.0
42	323.3	858.0	54	931.3	859.5
43	336.4	816.5	55	917.2	817.9
44	355.7	775.1	56	900.3	776.5
45	377.8	733.7	57	877.5	735.1
46	404.5	692.2	58	853.3	693.6
47	433.5	650.7	59	824.1	652.1
48	466.6	609.3	60	795.0	610.8
49	500.1	567.8	61	762.4	569.2
50	511.0	533.0	62	753.9	536.4

Exposure 2

Left			Right		
<u>n</u>	<u>x (mm)</u>	<u>y (mm)</u>	<u>n</u>	<u>x (mm)</u>	<u>y (mm)</u>
63	199.9	956.4	81	1058.1	981.0
64	193.8	915.0	82	1064.3	957.8
65	195.6	873.6	84	1065.8	916.4
66	201.7	832.1	84	1061.7	875.0
67	209.3	790.6	85	1056.0	833.5
68	221.8	749.3	86	1047.0	792.0
69	236.3	707.7	87	1034.4	750.7
70	254.3	666.3	88	1020.5	709.1
71	275.0	624.2	89	1003.9	667.7
72	297.3	583.5	90	985.3	626.3
73	322.7	542.0	91	962.6	584.8
74	350.0	500.6	92	939.1	543.3
75	377.2	459.2	93	912.4	501.9
76	405.0	417.6	94	887.7	460.5
77	432.7	376.2	95	860.2	419.0
78	466.2	334.8	96	833.6	377.6
79	500.8	293.3	97	802.9	366.2
80	513.9	257.4	98	768.4	294.7
			99	756.7	262.1

AQUARIUM DATA

Material: ANFO with 7.5 wt% aluminum      Shot no.: C-5125

Experimenter: S. Goldstein      Date: April 8, 1981

Charge diameter: 10 cm      Charge length: 91.4 cm

Initial density:  $0.77 \text{ g/cm}^3$       Temperature: 288 K

Confinement: 1.6-cm clay pipe in water

Booster: One 1E23 detonator, one P-040 lens, and a 10.2-cm-diam by 2.5-cm-long  
Comp B charge

Exposures of image intensifier camera: Two

Time between exposures:  $41.98 \mu\text{s}$       Detonation velocity: 3.41 km/s

Notes: ANFO is Gulf N-C-N 100 mixed with 7.5 wt% aluminum

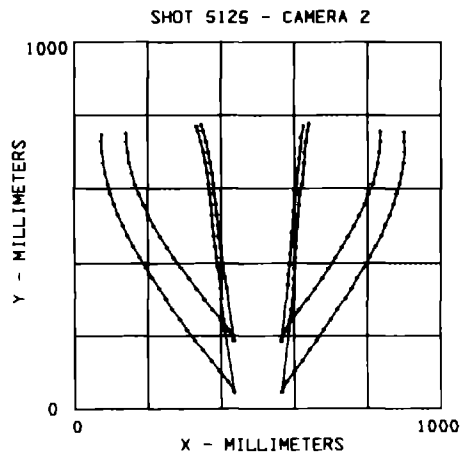
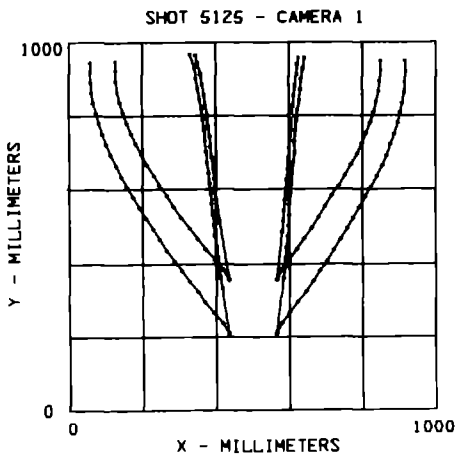

AQUARIUM DATA

SHOT 5125 - Camera 1  
EXPLOSIVE (PIPE) - WATER INTERFACE POSITIONS

Exposure 1

Left			Right		
<i>n</i>	<i>x</i> (mm)	<i>y</i> (mm)	<i>n</i>	<i>x</i> (mm)	<i>y</i> (mm)
1	344.9	965.1	19	625.4	956.6
2	349.6	943.1	20	622.1	940.5
3	359.0	914.6	21	620.0	912.0
4	363.9	886.1	22	616.2	883.5
5	368.4	857.6	23	613.8	855.0
6	372.3	829.0	24	610.6	826.4
7	376.4	800.6	25	607.1	797.9
8	378.3	772.1	26	604.2	769.5
9	382.8	743.5	27	601.6	741.0
10	385.5	714.9	28	600.3	712.4
11	388.3	686.5	29	597.4	683.9
12	391.7	658.0	30	594.5	655.4
13	395.8	629.5	31	592.1	626.9
14	398.7	600.9	32	590.9	598.4
15	402.1	572.4	33	588.5	569.8
16	405.3	544.0	34	585.2	541.3
17	409.2	515.4	35	583.7	512.9
18	435.7	354.6	36	579.8	484.3
			37	564.3	354.6

Exposure 2

Left			Right		
<i>n</i>	<i>x</i> (mm)	<i>y</i> (mm)	<i>n</i>	<i>x</i> (mm)	<i>y</i> (mm)
38	330.0	966.9	62	641.8	957.3
39	342.2	930.4	63	636.0	928.8
40	347.2	901.9	64	632.6	900.2
41	351.3	873.5	65	631.9	871.7
42	356.5	845.1	66	628.3	843.3
43	361.7	816.4	67	623.6	814.7
44	365.1	787.8	68	619.7	786.1
45	368.2	759.4	69	616.6	757.7
46	370.7	731.0	70	613.9	729.3
47	373.1	702.4	71	614.4	700.7
48	375.8	673.8	72	610.7	672.1

AQUARIUM DATA

49	379.5	645.3	73	607.1	643.7
50	382.4	616.9	74	605.2	615.2
51	386.3	588.3	75	603.6	586.6
52	389.0	559.8	76	600.8	558.1
53	391.9	531.3	77	599.9	529.6
54	394.2	502.9	78	597.8	501.2
55	397.0	474.3	79	596.3	472.6
56	401.3	445.8	80	591.8	444.1
57	404.7	417.3	81	589.8	415.6
58	407.5	388.8	82	586.9	387.1
59	411.3	360.2	83	582.8	358.4
60	416.6	331.7	84	564.3	209.4
61	435.7	209.4			

SHOCK FRONT POSITIONS

Exposure 1

Left			Right		
<i>n</i>	<i>x</i> (mm)	<i>y</i> (mm)	<i>n</i>	<i>x</i> (mm)	<i>y</i> (mm)
85	127.1	948.7	107	850.4	949.7
86	126.7	924.8	108	850.5	924.9
87	128.6	896.3	109	848.8	896.3
88	132.4	867.7	110	844.2	867.9
89	138.3	839.3	111	838.4	839.4
90	146.1	810.7	112	831.3	810.8
91	156.5	782.2	113	820.9	782.3
92	167.9	753.7	114	810.5	753.8
93	182.0	725.3	115	798.1	725.4
94	196.8	696.7	116	784.4	696.8
95	211.7	668.1	117	768.2	668.3
96	229.6	639.7	118	752.4	639.8
97	246.5	611.2	119	735.1	611.3
98	266.5	582.6	120	717.2	582.7
99	285.7	554.1	121	698.5	554.2
100	305.6	525.7	122	679.6	525.8
101	327.5	497.1	123	661.1	497.2
102	349.3	468.6	124	640.2	468.7
103	371.7	440.1	125	619.2	440.2
104	396.6	411.6	126	597.9	411.8
105	418.0	383.0	127	578.6	383.2
106	435.7	354.6	128	564.3	354.6



AQUARIUM DATA

Exposure 2

Left			Right		
<i>n</i>	<i>x</i> (mm)	<i>y</i> (mm)	<i>n</i>	<i>x</i> (mm)	<i>y</i> (mm)
129	58.9	945.6	156	916.3	949.3
130	58.7	922.6	157	918.2	922.2
131	59.6	894.1	158	917.4	893.6
132	62.3	865.6	159	914.9	865.2
133	66.8	837.2	160	910.6	836.7
134	73.4	808.6	161	903.9	808.1
135	81.5	780.1	162	896.7	779.6
136	90.6	751.5	163	887.7	751.2
137	101.3	723.0	164	877.3	722.6
138	113.2	694.3	165	866.1	694.1
139	127.7	665.7	166	852.7	665.5
140	142.3	637.3	167	838.7	637.1
141	158.0	608.6	168	823.2	608.6
142	174.2	580.0	169	808.1	580.0
143	191.2	551.6	170	791.2	551.6
144	209.7	523.1	171	775.8	523.1
145	228.7	494.5	172	757.8	494.5
146	245.9	466.0	173	739.8	466.0
147	264.7	437.5	174	722.4	437.6
148	287.2	409.0	175	703.8	409.1
149	306.8	380.4	176	684.1	380.5
150	327.0	352.0	177	664.9	352.0
151	350.3	323.5	178	644.6	323.5
152	370.5	295.0	179	623.7	295.0
153	394.1	266.4	180	601.7	266.4
154	417.9	237.9	181	579.9	237.9
155	435.7	209.4	182	564.3	209.4

SHOT 5125 - Camera 2  
EXPLOSIVE (PIPE) - WATER INTERFACE POSITIONS

Exposure 1

Left			Right		
<u><i>n</i></u>	<u>x (mm)</u>	<u>y (mm)</u>	<u><i>n</i></u>	<u>x (mm)</u>	<u>y (mm)</u>
1	347.4	772.9	19	624.8	770.7
2	351.5	755.9	20	618.2	738.2
3	360.1	727.3	21	615.9	709.6
4	364.4	698.7	22	613.5	681.2
5	369.8	670.3	23	610.8	652.7
6	374.3	641.8	24	606.6	624.1
7	378.9	613.2	25	603.3	595.6
8	382.2	584.6	26	601.1	567.1
9	385.9	556.2	27	598.6	538.7
10	388.1	527.7	28	596.2	510.0
11	391.1	499.2	29	593.6	481.5
12	393.8	470.7	30	591.4	453.1
13	397.5	442.2	31	589.0	424.6
14	401.5	413.7	32	586.3	396.0
15	405.5	385.1	33	583.4	367.5
16	409.9	356.6	34	582.3	339.0
17	415.8	328.1	35	564.3	186.2
18	435.7	186.2			

Exposure 2

Left			Right		
<u><i>n</i></u>	<u>x (mm)</u>	<u>y (mm)</u>	<u><i>n</i></u>	<u>x (mm)</u>	<u>y (mm)</u>
36	333.5	768.9	57	639.6	774.7
37	336.7	756.7	58	634.9	754.8
38	345.6	728.1	59	631.3	726.2
39	351.3	699.5	60	628.5	697.6
40	356.6	671.1	61	626.8	669.2
41	361.8	642.6	62	623.9	640.8
42	365.3	614.1	63	619.4	612.2
43	369.5	585.5	64	615.8	583.6
44	372.7	557.0	65	613.3	555.1
45	375.3	528.6	66	610.7	526.7
46	376.9	500.0	67	609.1	498.1
47	379.7	471.5	68	605.5	469.6

AQUARIUM DATA

48	384.0	443.1	69	602.5	441.1
49	386.8	414.5	70	601.6	412.7
50	390.4	386.0	71	599.6	384.1
51	394.6	357.4	72	598.7	355.6
52	397.5	329.0	73	597.2	327.1
53	399.9	300.5	74	594.5	298.6
54	406.3	243.4	75	591.0	270.0
55	410.3	214.9	76	587.9	241.5
56	435.7	45.1	77	584.3	213.0
			78	564.3	45.1

SHOCK FRONT POSITIONS

Exposure 1

Left			Right		
<u>n</u>	<u>x (mm)</u>	<u>y (mm)</u>	<u>n</u>	<u>x (mm)</u>	<u>y (mm)</u>
79	141.8	749.5	100	834.2	755.2
80	141.7	728.0	101	834.2	727.9
81	144.9	699.4	102	832.4	699.4
82	149.1	671.0	103	827.6	670.9
83	156.8	642.6	104	821.0	642.5
84	164.1	614.0	105	812.5	613.9
85	175.9	585.4	106	803.2	585.3
86	187.7	557.0	107	791.0	556.9
87	201.9	528.6	108	777.7	528.4
88	217.4	500.0	109	762.9	499.9
89	233.6	471.4	110	747.4	471.3
90	251.0	442.9	111	729.9	442.9
91	270.0	414.5	112	711.9	414.4
92	290.7	385.9	113	693.2	385.8
93	310.9	357.4	114	674.9	357.3
94	332.0	328.8	115	654.7	328.8
95	353.9	300.3	116	635.0	300.3
96	376.7	271.7	117	613.2	271.7
97	400.2	243.2	118	591.6	243.3
98	420.9	214.8	119	573.3	214.8
99	435.7	186.2	120	564.3	186.2

## AQUARIUM DATA

## Exposure 2

Left			Right		
<i>n</i>	<i>x</i> (mm)	<i>y</i> (mm)	<i>n</i>	<i>x</i> (mm)	<i>y</i> (mm)
121	74.5	747.3	147	900.0	754.7
122	74.0	729.5	148	900.5	729.5
123	75.1	700.9	149	901.1	700.9
124	78.5	672.4	150	898.6	672.4
125	82.9	644.0	151	893.7	644.0
126	89.5	615.5	152	886.5	615.4
127	97.8	586.9	153	879.6	586.8
128	108.3	558.4	154	871.0	558.4
129	118.5	530.0	155	861.2	530.0
130	130.9	501.4	156	848.2	501.4
131	145.4	472.8	157	837.5	472.8
132	160.3	444.4	158	821.3	444.3
133	176.4	415.9	159	805.3	415.9
134	193.4	387.4	160	789.7	387.3
135	211.5	358.8	161	772.3	358.8
136	230.2	330.3	162	756.1	330.3
137	248.5	301.8	163	737.5	301.8
138	266.9	273.3	164	717.9	273.2
139	287.7	244.8	165	700.3	244.8
140	306.8	216.3	166	680.5	216.3
141	327.8	187.8	167	662.3	187.8
142	350.5	159.2	168	641.8	159.2
143	372.5	130.7	169	621.1	130.7
144	394.9	102.3	170	599.3	102.2
145	417.8	73.7	171	577.6	73.7
146	435.7	45.1	172	564.3	45.1

**AQUARIUM DATA**

**Material:** ANFO with 7.5 wt% aluminum      **Shot no.:** C-4724

**Experimenter:** B. G. Craig      **Date:** September 28, 1977

**Charge diameter:** 9.8 cm      **Charge length:** 120.7 cm

**Initial density:** 0.874 g/cm<sup>3</sup>      **Temperature:** 297 K

**Confinement:** Red clay pipe, 1.55-cm wall with 12.9-cm o.d., in water

**Booster:** One SE-1 detonator, one tetryl pellet, and a 10.8-cm-diam by 1.25-cm-long TNT charge

**Exposures of image intensifier camera:** Two

**Time between exposures:** 101.6 μs      **Detonation velocity:** 3.63 km/s

**Notes:** ANFO is Gulf N-C-N 750 manufactured by Gulf Oil Chemical Co., Merriam, Kansas

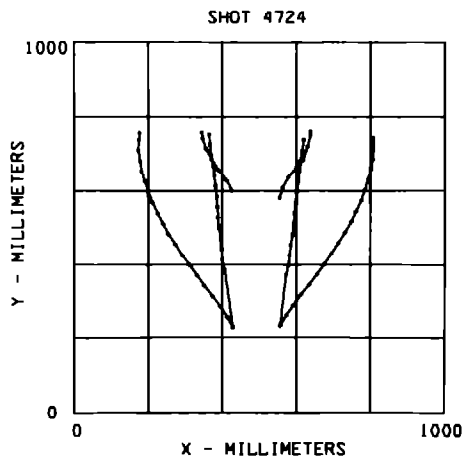

SHOT 4724  
EXPLOSIVE (PIPE) - WATER INTERFACE POSITIONS

Exposure 2

Left			Right		
<i>n</i>	<i>x</i> (mm)	<i>y</i> (mm)	<i>n</i>	<i>x</i> (mm)	<i>y</i> (mm)
1	365.7	752.5	16	620.6	736.3
2	366.5	724.3	17	616.8	708.2
3	370.6	696.2	18	612.3	680.0
4	374.9	668.0	19	608.6	651.8
5	378.2	639.6	20	605.5	623.6
6	381.4	611.4	21	601.6	595.5
7	384.4	583.3	22	598.5	567.2
8	386.7	554.9	23	595.5	538.7
9	388.6	526.7	24	592.7	510.6
10	391.1	498.6	25	589.5	482.3
11	394.5	470.4	26	585.8	454.1
12	397.6	442.0	27	582.4	425.6
13	399.8	413.8	28	577.6	397.4
14	405.9	385.7	29	572.4	369.3
15	427.6	229.8	30	556.1	234.3

SHOCK FRONT POSITIONS

Exposure 1

Left			Right		
<i>n</i>	<i>x</i> (mm)	<i>y</i> (mm)	<i>n</i>	<i>x</i> (mm)	<i>y</i> (mm)
31	345.8	759.0	38	638.2	761.8
32	346.9	741.7	39	638.7	750.2
33	356.2	713.4	40	632.2	722.0
34	371.3	685.3	41	618.4	683.2
35	390.7	656.8	42	601.2	665.5
36	410.9	628.7	43	578.4	637.3
37	427.0	600.4	44	563.6	609.1
			45	555.6	580.9

AQUARIUM DATA

Exposure 2

Left			Right		
<i>n</i>	<i>x</i> (mm)	<i>y</i> (mm)	<i>n</i>	<i>x</i> (mm)	<i>y</i> (mm)
46	176.4	756.5	66	808.5	743.8
47	174.4	738.5	67	808.2	715.5
48	173.9	710.3	68	806.1	687.2
49	177.7	682.1	69	801.4	658.9
50	182.4	653.8	70	793.6	630.5
51	191.0	625.5	71	785.1	602.3
52	199.8	597.2	72	744.9	574.0
53	211.8	568.9	73	761.8	545.7
54	224.7	540.5	74	747.9	517.3
55	239.4	512.2	75	731.3	489.1
56	255.1	484.1	76	713.7	460.8
57	273.0	455.9	77	694.7	432.4
58	291.0	427.4	78	676.2	404.1
59	310.9	399.3	79	656.0	375.8
60	331.1	371.2	80	634.7	347.5
61	351.2	343.0	81	612.5	319.2
62	372.8	314.6	82	592.1	290.8
63	394.8	286.3	83	573.8	262.6
64	413.9	258.2	84	556.1	234.3
65	427.6	229.8			

AQUARIUM DATA

**Material:** ANFO with 7.5 wt% aluminum    **Shot no.:** C-4707

**Experimenter:** B. G. Craig    **Date:** June 16, 1977

**Charge diameter:** 20.20 cm    **Charge length:** 151.1 cm

**Initial density:** 0.877 g/cm<sup>3</sup>    **Temperature:** 296 K

**Confinement:** Clay pipe, 2.41-cm wall with 25.02-cm o.d., in water

**Booster:** One SE-1 detonator, one tetryl pellet, and a 2.5-cm-diam by 2.03-cm-long TNT charge

**Exposures of image intensifier camera:** Two

**Time between exposures:** 102.0  $\mu$ s    **Detonation velocity:** 3.98 km/s

**Notes:** ANFO is Gulf N-C-N 750 manufactured by Gulf Oil Chemical Co., Merriam, Kansas

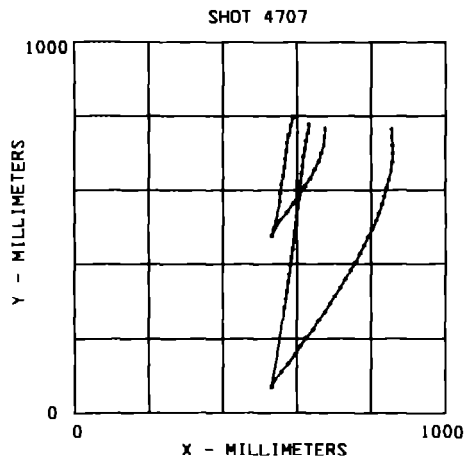



AQUARIUM DATA

SHOT 4707  
EXPLOSIVE (PIPE) - WATER INTERFACE POSITIONS

Exposure 1

Right		
<i>n</i>	<i>x</i> (mm)	<i>y</i> (mm)
1	588.2	793.7
2	580.9	771.3
3	578.1	748.9
4	574.1	726.3
5	571.1	703.8
6	567.7	681.3
7	564.4	658.8
8	562.1	636.4
9	558.7	613.9
10	555.6	591.3
11	552.5	568.8
12	533.2	474.2

Exposure 2

Right		
<i>n</i>	<i>x</i> (mm)	<i>y</i> (mm)
13	631.9	776.6
14	628.5	754.1
15	625.4	731.6
16	621.3	709.1
17	617.1	686.6
18	614.3	664.1
19	611.5	641.7
20	609.5	619.1
21	606.5	596.7
22	604.3	574.1
23	601.6	551.6
24	598.9	529.1
25	596.0	506.7
26	594.6	484.2
27	591.2	461.6
28	588.4	439.1
29	584.9	416.6
30	582.1	394.2

AQUARIUM DATA

31	579.2	371.7
32	576.1	349.2
33	573.2	326.6
34	569.8	304.2
35	567.0	281.6
36	532.0	68.1

SHOCK FRONT POSITIONS

Exposure 1

Right

<u>n</u>	<u>x (mm)</u>	<u>y (mm)</u>
37	675.6	766.7
38	675.3	744.2
39	673.0	721.7
40	666.4	699.2
41	658.0	676.7
42	646.9	654.2
43	635.5	631.8
44	621.1	609.3
45	606.2	586.7
46	590.3	564.2
47	573.1	541.7
48	555.1	519.3
49	542.3	496.8
50	533.2	474.2

Exposure 2

Right

<u>n</u>	<u>x (mm)</u>	<u>y (mm)</u>
51	855.1	765.6
52	857.0	743.1
53	858.3	720.6
54	858.1	698.0
55	856.2	675.5
56	852.9	653.1
57	848.4	630.6
58	842.8	608.1
59	836.4	585.6
60	829.5	563.0

## AQUARIUM DATA

61	822.1	540.6
62	813.0	518.1
63	804.6	495.7
64	792.9	473.1
65	781.3	450.6
66	770.5	428.1
67	758.9	405.6
68	745.2	383.2
69	732.2	360.6
70	719.1	338.1
71	703.8	315.6
72	689.2	293.1
73	674.7	270.7
74	659.0	248.2
75	644.3	225.7
76	627.3	203.1
77	610.6	180.6
78	595.2	158.1
79	577.1	135.7
80	559.5	113.2
81	542.1	90.7
82	532.0	68.1

AQUARIUM DATA

**Material:** ANFO with 7.5 wt% aluminum      **Shot no.:** C-4743

**Experimenter:** B. G. Craig      **Date:** December 7, 1977

**Charge diameter:** 19.9 cm      **Charge length:** 151.3 cm

**Initial density:** 1.06 g/cm<sup>3</sup>      **Temperature:** 293 K

**Confinement:** Clay pipe, 2.52-cm wall with 19.9-cm i.d., in water

**Booster:** One SE-1 detonator, one PBX-9407 pellet, and one 20.3-cm-diam by 2.5-cm-long TNT charge

**Exposures of image intensifier camera:** Two

**Time between exposures:** 64.75 μs      **Detonation velocity:** 3.985 km/s

**Notes:** ANFO is Gulf N-C-N 750 manufactured by Gulf Oil Chemical Co., Merriam, Kansas

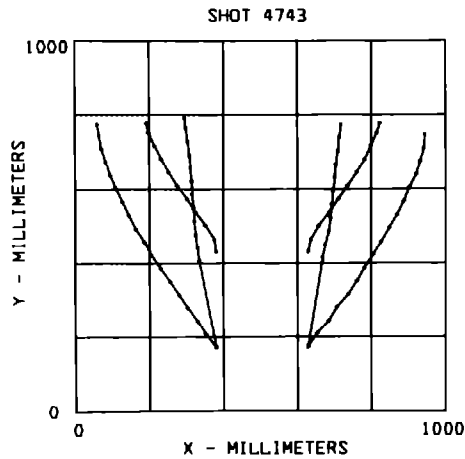

AQUARIUM DATA

SHOT 4743  
EXPLOSIVE (PIPE) - WATER INTERFACE POSITIONS

Exposure 2

Left			Right		
<i>n</i>	<i>x</i> (mm)	<i>y</i> (mm)	<i>n</i>	<i>x</i> (mm)	<i>y</i> (mm)
1	296.0	790.3	14	718.8	773.5
2	298.8	764.3	15	713.4	737.6
3	303.3	728.4	16	710.0	701.7
4	308.2	692.5	17	705.5	665.8
5	312.4	656.5	18	701.5	630.0
6	314.6	620.7	19	696.8	594.1
7	317.2	584.8	20	692.8	558.1
8	320.1	548.9	21	689.5	522.2
9	322.1	513.0	22	684.5	486.4
10	324.6	477.1	23	674.4	450.5
11	329.4	441.3	24	667.8	414.5
12	335.3	405.2	25	629.0	173.6
13	380.1	172.2			

SHOCK FRONT POSITIONS

Exposure 1

Left			Right		
<i>n</i>	<i>x</i> (mm)	<i>y</i> (mm)	<i>n</i>	<i>x</i> (mm)	<i>y</i> (mm)
26	193.7	778.3	37	822.5	778.0
27	198.8	754.1	38	817.0	754.1
28	214.6	718.1	39	799.7	718.7
29	233.7	682.2	40	784.1	682.2
30	251.5	646.3	41	761.8	646.3
31	275.2	610.5	42	737.4	610.6
32	301.0	574.6	43	712.2	574.6
33	324.9	538.6	44	685.9	538.6
34	352.1	502.7	45	657.8	502.7
35	375.4	466.9	46	636.4	466.9
36	380.1	430.9	47	629.0	430.9

## Exposure 2

Left			Right		
<i>n</i>	x (mm)	y (mm)	<i>n</i>	x (mm)	y (mm)
48	60.1	775.3	66	944.4	748.0
49	64.2	746.5	67	943.7	712.0
50	71.6	710.6	68	934.1	676.0
51	82.6	674.6	69	922.3	640.1
52	95.1	638.8	70	903.6	604.3
53	109.8	602.9	71	887.7	568.4
54	127.9	567.0	72	870.2	532.5
55	145.1	531.0	73	847.8	496.7
56	163.6	495.2	74	826.8	460.7
57	186.2	459.3	75	805.0	424.8
58	204.9	423.4	76	781.1	388.9
59	230.7	387.5	77	761.2	353.1
60	255.1	351.6	78	738.3	317.1
61	279.4	315.7	79	706.6	281.2
62	303.7	279.9	80	684.4	245.3
63	329.2	243.9	81	653.4	209.5
64	352.4	208.7	82	629.0	173.6
65	380.1	172.2			

AQUARIUM DATA

**Material:** ANFO with 10.8 wt% aluminum      **Shot no.:** C-5088

**Experimenter:** S. Goldstein      **Date:** December 12, 1980

**Charge diameter:** 10 cm      **Charge length:** 91.4 cm

**Initial density:** 0.80 g/cm<sup>3</sup>      **Temperature:** 285 K

**Confinement:** 1.6-cm clay pipe in water

**Booster:** One 1E23 detonator, one P-040 lens, and two 10.2-cm-diam by 1.3-cm-long Comp B charges

**Exposures of image intensifier camera:** Two

**Time between exposures:** 29.03  $\mu$ s      **Detonation velocity:** 3.29 km/s

**Notes:** ANFO is Gulf N-C-N 100 manufactured by Gulf Oil Chemical Co., Merriam, Kansas

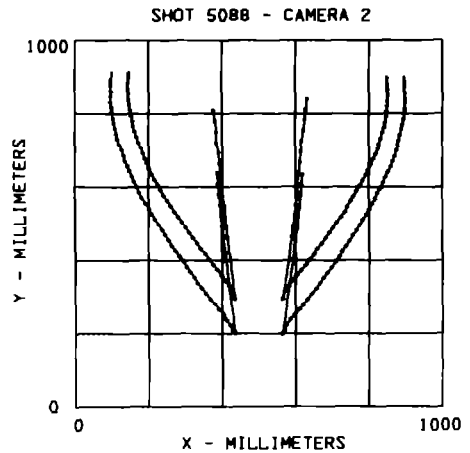
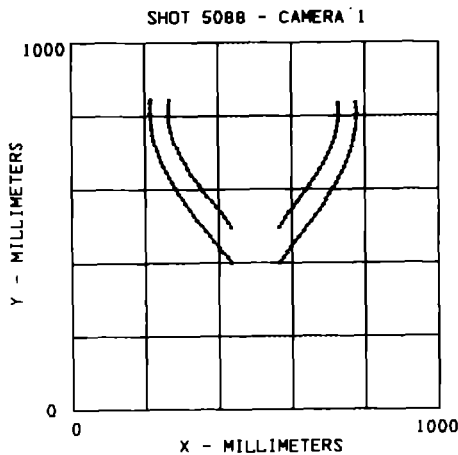

SHOT 5088 - Camera 1  
SHOCK FRONT POSITIONS

Exposure 1

Left			Right		
<u>n</u>	<u>x (mm)</u>	<u>y (mm)</u>	<u>n</u>	<u>x (mm)</u>	<u>y (mm)</u>
1	265.9	843.9	26	726.6	834.8
2	264.9	829.1	27	727.4	829.2
3	265.1	814.6	28	727.7	814.7
4	265.3	800.1	29	727.5	800.1
5	265.2	785.5	30	727.1	785.6
6	268.5	771.0	31	725.3	771.1
7	272.0	756.4	32	722.2	756.5
8	275.4	742.0	33	717.5	742.1
9	280.4	727.5	34	712.5	727.6
10	287.1	713.0	35	707.0	713.1
11	293.5	698.5	36	700.8	698.6
12	300.0	684.0	37	693.8	684.0
13	309.2	669.4	38	686.2	669.5
14	317.3	654.9	39	677.3	655.0
15	325.6	640.4	40	668.1	640.4
16	336.4	625.9	41	658.9	626.0
17	347.5	611.4	42	648.5	611.5
18	357.3	596.9	43	638.3	597.0
19	368.9	582.4	44	627.3	582.5
20	381.8	567.8	45	614.6	567.9
21	393.3	553.3	46	603.2	553.4
22	406.2	538.7	47	590.2	538.9
23	417.3	524.2	48	581.3	524.4
24	427.1	509.8	49	572.5	509.9
25	435.0	495.4	50	565.0	495.4

Exposure 2

Left			Right		
<u>n</u>	<u>x (mm)</u>	<u>y (mm)</u>	<u>n</u>	<u>x (mm)</u>	<u>y (mm)</u>
51	216.1	843.9	83	775.5	834.8
52	215.7	835.4	84	777.4	820.1
53	215.6	821.0	85	777.6	805.5
54	214.7	806.4	86	777.2	791.1
55	216.0	791.9	87	776.4	776.6



AQUARIUM DATA

56	217.7	777.3	88	774.8	762.1
57	219.4	762.8	89	772.0	747.5
58	221.4	748.3	90	768.6	733.0
59	224.5	733.8	91	764.7	718.6
60	228.7	719.3	92	760.4	704.1
61	233.3	704.8	93	755.2	689.5
62	238.8	690.3	94	749.6	675.1
63	243.9	675.7	95	742.7	660.5
64	250.2	661.2	96	737.0	646.0
65	258.0	646.7	97	728.9	631.6
66	266.1	632.3	98	721.1	617.0
67	275.0	617.7	99	713.3	602.6
68	282.7	603.3	100	703.4	588.0
69	291.8	588.7	101	693.9	573.6
70	301.5	574.2	102	685.6	559.0
71	310.8	559.6	103	676.0	544.5
72	320.9	545.1	104	664.0	530.0
73	332.3	530.6	105	652.7	515.5
74	342.1	516.1	106	642.2	500.9
75	353.5	501.7	107	632.8	486.6
76	364.8	487.2	108	620.7	472.2
77	376.6	472.7	109	609.0	457.8
78	386.2	458.1	110	597.6	443.2
79	401.5	443.6	111	585.9	428.8
80	411.2	429.0	112	576.3	414.3
81	424.4	414.5	113	565.0	400.0
82	435.0	400.0			

SHOT 5088 - Camera 2  
EXPLOSIVE (PIPE) - WATER INTERFACE POSITIONS

Exposure 1

Left			Right		
<i>n</i>	<i>x</i> (mm)	<i>y</i> (mm)	<i>n</i>	<i>x</i> (mm)	<i>y</i> (mm)
1	377.3	806.2	15	632.3	839.0
2	381.2	777.6	16	628.7	810.0
3	384.2	748.5	17	625.3	781.2
4	384.6	719.7	18	621.3	752.2
5	389.2	690.9	19	617.0	723.1
6	392.6	662.1	20	614.1	694.2

AQUARIUM DATA

7	394.2	633.0	21	611.1	665.3
8	398.8	604.0	22	607.6	636.2
9	402.3	575.1	23	605.3	607.3
10	404.8	546.1	24	603.7	578.3
11	408.3	517.2	25	600.4	549.5
12	411.4	488.3	26	596.8	520.6
13	415.6	459.4	27	592.7	491.8
14	435.0	295.2	28	589.7	463.1
			29	565.0	295.4

Exposure 2

Left			Right		
<u>n</u>	<u>x (mm)</u>	<u>y (mm)</u>	<u>n</u>	<u>x (mm)</u>	<u>y (mm)</u>
30	387.0	636.3	39	619.0	631.8
31	389.9	607.5	40	616.4	602.8
32	391.8	578.8	41	612.7	573.9
33	394.3	550.1	42	609.7	544.9
34	396.6	521.3	43	606.2	515.9
35	400.7	492.5	44	604.3	486.8
36	403.6	463.7	45	600.6	458.1
37	408.8	420.2	46	565.0	200.0
38	435.0	200.0			

SHOCK FRONT POSITIONS

Exposure 1

Left			Right		
<u>n</u>	<u>x (mm)</u>	<u>y (mm)</u>	<u>n</u>	<u>x (mm)</u>	<u>y (mm)</u>
47	148.4	908.6	90	849.4	895.7
48	147.0	896.2	91	851.5	877.2
49	145.1	881.6	92	852.1	862.8
50	144.7	867.2	93	851.9	848.4
51	145.1	852.6	94	850.7	834.0
52	145.3	838.1	95	849.5	819.6
53	147.5	823.7	96	848.2	805.3
54	149.6	809.2	97	846.9	790.9
55	152.6	794.7	98	844.7	776.6
56	156.1	780.3	99	841.3	762.2
57	159.0	765.7	100	836.9	747.8

AQUARIUM DATA

58	163.2	751.2	101	832.8	733.4
59	168.0	736.7	102	828.8	718.9
60	172.5	722.2	103	823.1	704.5
61	177.6	707.7	104	817.5	690.2
62	182.7	693.2	105	811.6	675.9
63	188.1	678.8	106	805.1	661.5
64	195.5	664.3	107	798.5	647.1
65	201.5	649.8	108	791.0	632.7
66	209.1	635.3	109	782.8	618.4
67	216.7	620.8	110	775.1	603.9
68	225.1	606.3	111	766.8	589.5
69	233.7	591.7	112	758.9	575.2
70	242.3	577.3	113	749.0	560.9
71	250.8	562.8	114	740.3	546.5
72	260.1	548.4	115	732.5	532.1
73	270.5	533.9	116	722.7	517.7
74	280.1	519.3	117	712.3	503.3
75	289.5	504.9	118	701.5	488.9
76	299.6	490.3	119	691.5	474.5
77	309.2	475.8	120	682.0	460.2
78	319.9	461.4	121	671.4	445.8
79	331.4	446.9	122	659.8	431.5
80	341.8	432.5	123	649.5	417.1
81	352.5	417.9	124	638.7	402.6
82	363.5	403.4	125	627.5	388.2
83	375.4	388.9	126	615.6	373.9
84	386.0	374.4	127	602.7	359.5
85	397.9	359.9	128	590.7	345.2
86	410.1	345.5	129	582.0	330.8
87	420.5	331.0	130	570.8	316.4
88	427.9	316.5	131	565.0	295.4
89	435.0	295.4			

Exposure 2

Left			Right		
<i>n</i>	<i>x</i> (mm)	<i>y</i> (mm)	<i>n</i>	<i>x</i> (mm)	<i>y</i> (mm)
132	102.4	908.6	182	896.8	895.2
133	98.8	889.6	183	898.2	885.6
134	98.2	875.2	184	898.2	871.3
135	98.0	860.7	185	898.8	856.8

AQUARIUM DATA

136	97.2	846.1	186	899.1	842.4
137	97.4	831.6	187	898.8	828.0
138	99.4	817.1	188	897.7	813.6
139	100.4	802.7	189	896.5	799.3
140	103.0	788.2	190	894.6	785.0
141	106.5	773.7	191	891.7	770.5
142	109.8	759.2	192	888.5	756.0
143	113.2	744.7	193	885.1	741.6
144	116.4	730.2	194	882.4	727.1
145	121.7	715.7	195	878.3	712.6
146	125.9	701.1	196	873.8	698.2
147	131.1	686.7	197	869.3	683.9
148	135.7	672.2	198	864.6	669.5
149	141.2	657.8	199	859.3	655.2
150	147.8	643.3	200	852.1	640.8
151	154.4	628.7	201	845.0	626.2
152	160.0	614.2	202	838.9	611.8
153	167.7	599.7	203	832.2	597.4
154	174.5	585.2	204	823.9	583.1
155	182.4	570.8	205	816.6	568.7
156	190.3	556.3	206	808.5	554.4
157	199.5	541.9	207	799.9	539.9
158	207.6	527.3	208	792.0	525.5
159	216.5	512.8	209	782.9	510.9
160	226.3	498.3	210	774.6	496.5
161	237.1	483.8	211	766.0	482.1
162	245.5	469.3	212	756.9	467.9
163	254.7	454.9	213	748.3	453.5
164	264.1	440.4	214	739.0	439.1
165	273.6	426.0	215	729.0	424.8
166	282.9	411.4	216	718.5	410.2
167	294.7	396.9	217	708.3	395.8
168	304.1	382.3	218	697.5	381.4
169	313.5	367.8	219	687.3	367.0
170	324.3	353.4	220	676.9	352.7
171	333.5	338.9	221	666.9	338.3
172	345.1	324.4	222	656.6	324.0
173	356.8	310.0	223	644.4	309.6
174	368.1	295.4	224	633.7	295.2
175	379.3	280.9	225	621.6	280.8
176	390.3	266.4	226	609.2	266.4

## AQUARIUM DATA

177	403.0	251.9	227	596.7	252.0
178	411.8	237.5	228	584.9	237.7
179	421.8	223.0	229	575.3	223.4
180	429.1	208.8	230	569.4	208.9
181	435.0	200.0	231	565.0	200.0

AQUARIUM DATA

Material: ANFO with 18.91 wt% aluminum Shot no.: C-5066

Experimenter: S. Goldstein Date: October 1, 1980

Charge diameter: 10 cm Charge length: 91.4 cm

Initial density:  $0.93 \text{ g/cm}^3$  Temperature: 285 K

Confinement: 1.6-cm clay pipe in water

Booster: One 1E23 detonator, one P-040 lens, and two 10.2-cm-diam by 1.3-cm-long Comp B charges

Exposures of image intensifier camera: Two

Time between exposures:  $29.04 \mu\text{s}$  Detonation velocity: 3.49 km/s

Notes: ANFO is Gulf N-C-N 100 manufactured by Gulf Oil Chemical Co., Merriam, Kansas

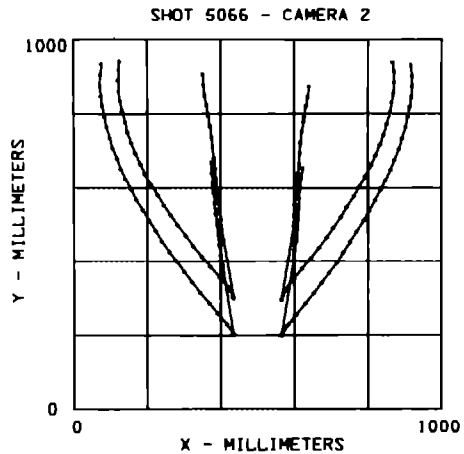
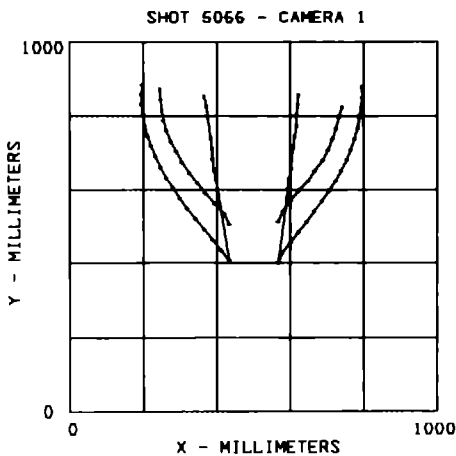

AQUARIUM DATA

SHOT 5066 - Camera 1  
EXPLOSIVE (PIPE) - WATER INTERFACE POSITIONS

Exposure 2

Left			Right		
<i>n</i>	<i>x</i> (mm)	<i>y</i> (mm)	<i>n</i>	<i>x</i> (mm)	<i>y</i> (mm)
1	364.6	853.0	10	622.3	856.1
2	371.8	825.0	11	619.6	828.0
3	375.0	796.8	12	616.7	799.8
4	383.2	740.3	13	616.1	771.6
5	386.9	712.2	14	611.9	743.4
6	389.0	684.0	15	607.6	715.3
7	392.3	655.7	16	603.3	687.1
8	397.9	627.5	17	601.1	658.8
9	434.1	408.7	18	597.2	630.6
			19	594.0	602.5
			20	589.2	572.9
			21	566.7	400.0

SHOCK FRONT POSITIONS

Exposure 1

Left			Right		
<i>n</i>	<i>x</i> (mm)	<i>y</i> (mm)	<i>n</i>	<i>x</i> (mm)	<i>y</i> (mm)
22	245.4	873.4	36	741.5	823.1
23	246.9	845.3	37	731.1	794.9
24	249.9	817.1	38	725.2	766.6
25	255.3	788.9	39	714.4	738.5
26	263.0	760.7	40	702.6	710.3
27	274.2	732.4	41	687.5	682.1
28	289.3	704.2	42	666.7	653.9
29	305.0	676.0	43	647.6	625.7
30	325.3	647.7	44	624.1	597.6
31	346.8	619.6	45	600.7	569.3
32	369.1	591.4	46	580.0	541.1
33	393.8	563.1	47	566.2	512.9
34	419.5	534.8			
35	433.0	506.6			

## Exposure 2

Left			Right		
<i>n</i>	<i>x</i> (mm)	<i>y</i> (mm)	<i>n</i>	<i>x</i> (mm)	<i>y</i> (mm)
48	197.3	884.2	66	794.2	879.4
49	195.3	860.4	67	797.3	851.2
50	195.5	832.2	68	792.5	823.1
51	199.2	804.0	69	788.3	794.8
52	203.9	775.7	70	782.8	766.5
53	211.5	747.5	71	774.5	738.4
54	221.0	719.2	72	764.6	710.2
55	232.7	691.0	73	752.7	682.0
56	247.4	662.7	74	737.6	653.8
57	261.8	634.6	75	722.9	625.6
58	279.3	606.4	76	704.9	597.4
59	298.2	578.3	77	686.7	569.2
60	318.0	550.0	78	665.5	541.0
61	341.3	521.8	79	645.3	512.8
62	364.3	493.6	80	622.1	484.7
63	388.7	465.4	81	600.0	456.5
64	411.8	437.0	82	576.9	428.2
65	434.1	408.7	83	566.7	400.0

## SHOT 5066 - Camera 2

## EXPLOSIVE (PIPE) - WATER INTERFACE POSITIONS

## Exposure 1

Left			Right		
<i>n</i>	<i>x</i> (mm)	<i>y</i> (mm)	<i>n</i>	<i>x</i> (mm)	<i>y</i> (mm)
1	352.0	906.0	19	639.8	873.0
2	354.1	877.8	20	636.1	844.8
3	357.4	849.6	21	631.3	818.3
4	361.2	821.5	22	627.2	790.1
5	366.6	793.4	23	624.5	777.4
6	371.5	765.2	24	620.6	749.2
7	375.6	737.0	25	617.3	721.1
8	377.5	708.9	26	615.4	693.0
9	381.0	680.8	27	612.9	664.8
10	384.3	652.5	28	609.8	636.6
11	386.1	624.3	29	606.8	608.5



AQUARIUM DATA

12	389.8	596.3	30	604.5	580.4
13	392.7	568.2	31	601.8	552.2
14	396.1	540.0	32	599.2	524.0
15	400.4	511.7	33	597.7	495.8
16	403.9	483.7	34	565.3	295.3
17	409.0	455.5			
18	434.6	300.7			

Exposure 2

Left			Right		
<i>n</i>	<i>x</i> (mm)	<i>y</i> (mm)	<i>n</i>	<i>x</i> (mm)	<i>y</i> (mm)
35	374.5	668.9	47	622.7	653.6
36	376.3	640.7	48	618.8	625.4
37	378.8	612.5	49	615.2	597.3
38	382.2	584.5	50	613.1	569.2
39	383.7	556.3	51	611.3	541.0
40	386.0	528.0	52	609.7	512.8
41	390.1	500.0	53	608.0	484.7
42	393.9	471.8	54	606.1	456.6
43	397.0	443.7	55	600.5	428.3
44	400.3	415.5	56	598.6	400.3
45	404.9	387.3	57	565.3	200.0
46	434.8	202.2			

SHOCK FRONT POSITIONS

Exposure 1

Left			Right		
<i>n</i>	<i>x</i> (mm)	<i>y</i> (mm)	<i>n</i>	<i>x</i> (mm)	<i>y</i> (mm)
58	125.7	942.1	82	866.9	939.8
59	122.8	920.1	83	871.2	914.8
60	121.5	892.0	84	871.8	886.6
61	122.9	863.7	85	869.2	858.3
62	127.1	835.6	86	865.0	830.3
63	132.8	807.5	87	859.2	802.1
64	139.4	779.3	88	851.2	774.0
65	147.3	751.1	89	842.5	745.8
66	156.9	723.0	90	832.6	717.6
67	168.3	694.9	91	821.3	689.5
68	180.9	666.7	92	808.3	661.3

AQUARIUM DATA

69	194.9	638.5	93	793.9	633.2
70	210.8	610.4	94	778.5	605.1
71	227.7	582.3	95	762.1	576.9
72	245.1	554.1	96	744.1	548.7
73	263.8	525.9	97	726.1	520.6
74	283.0	497.8	98	707.1	492.5
75	304.8	469.7	99	688.2	464.3
76	325.2	441.5	100	667.1	436.1
77	347.7	413.3	101	645.0	407.9
78	371.5	385.2	102	622.4	379.8
79	397.1	357.0	103	598.3	351.7
80	421.4	328.8	104	577.4	323.5
81	434.6	300.7	105	565.3	295.3

Exposure 2

Left			Right		
<i>n</i>	<i>x</i> (mm)	<i>y</i> (mm)	<i>n</i>	<i>x</i> (mm)	<i>y</i> (mm)
106	76.9	934.3	133	916.4	932.1
107	73.4	906.1	134	920.0	903.9
108	72.0	878.0	135	920.8	875.7
109	74.8	849.8	136	918.7	847.5
110	78.1	821.7	137	914.9	819.5
111	83.4	793.5	138	908.8	791.3
112	90.6	765.3	139	901.8	763.1
113	98.1	737.1	140	893.4	734.9
114	106.8	709.1	141	884.4	706.8
115	117.7	681.0	142	874.0	678.7
116	128.4	652.7	143	861.7	650.5
117	141.8	624.5	144	848.8	622.3
118	156.1	596.5	145	835.3	594.3
119	170.5	568.3	146	820.2	566.1
120	188.1	540.1	147	804.2	537.9
121	204.9	512.0	148	788.1	509.7
122	222.6	483.9	149	770.3	481.6
123	240.7	455.8	150	752.1	453.5
124	259.2	427.5	151	733.6	425.3
125	279.8	399.3	152	716.0	397.1
126	300.2	371.3	153	695.7	369.1
127	322.0	343.1	154	674.5	340.9
128	342.5	314.9	155	652.6	312.7

## AQUARIUM DATA

129	367.6	286.8	156	629.9	284.5
130	391.5	258.7	157	606.7	256.5
131	416.2	230.5	158	583.3	228.3
132	434.8	202.2	159	565.3	200.0

AQUARIUM DATA

Material: ANFO with 19.32 wt% aluminum      Shot no.: C-5097

Experimenter: S. Goldstein      Date: January 23, 1981

Charge diameter: 10.2 cm      Charge length: 122 cm

Initial density: 0.90 g/cm<sup>3</sup>      Temperature: 282 K

Confinement: 1.6-cm clay pipe in water

Booster: One 1E23 detonator, one P-040 lens, and a 10.2-cm-diam by 10.2-cm-long  
Comp B charge

Exposures of image intensifier camera: Two

Time between exposures: 39.03  $\mu$ s      Detonation velocity: 3.51 km/s

Notes: ANFO is Gulf N-C-N 100 manufactured by Gulf Oil Chemical Co., Merriam,  
Kansas

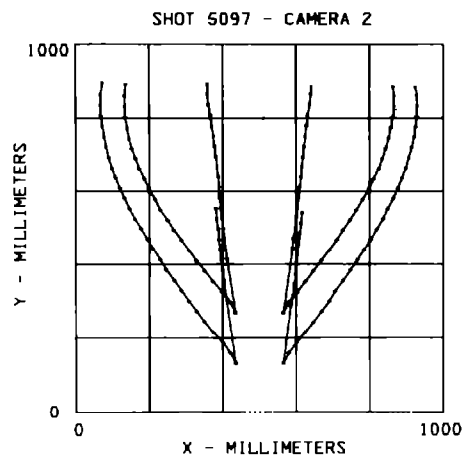
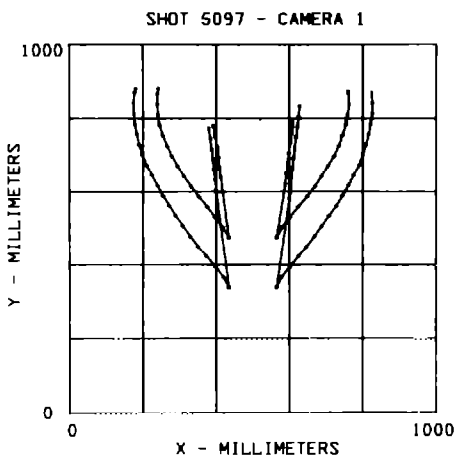

AQUARIUM DATA

SHOT 5097 - Camera 1  
EXPLOSIVE (PIPE) - WATER INTERFACE POSITIONS

Exposure 1

Left			Right		
<u>n</u>	<u>x (mm)</u>	<u>y (mm)</u>	<u>n</u>	<u>x (mm)</u>	<u>y (mm)</u>
1	393.9	777.6	8	610.8	788.4
2	397.8	749.9	9	606.8	760.5
3	402.8	722.0	10	601.9	732.6
4	406.3	694.1	11	598.9	704.6
5	408.2	666.4	12	595.0	676.7
6	412.7	638.5	13	592.2	648.8
7	435.5	475.6	14	588.9	620.8
			15	564.5	475.6

Exposure 2

Left			Right		
<u>n</u>	<u>x (mm)</u>	<u>y (mm)</u>	<u>n</u>	<u>x (mm)</u>	<u>y (mm)</u>
16	380.7	771.6	24	628.2	831.7
17	384.9	743.7	25	625.0	803.7
18	388.6	715.7	26	621.7	775.8
19	391.2	687.8	27	618.3	747.9
20	393.3	659.9	28	615.1	720.0
21	398.0	632.0	29	611.2	692.0
22	399.2	604.0	30	607.8	664.2
23	435.5	338.7	31	605.6	636.2
			32	603.0	608.3
			33	600.1	580.3
			34	564.5	338.7

SHOCK FRONT POSITIONS

Exposure 1

Left			Right		
<u>n</u>	<u>x (mm)</u>	<u>y (mm)</u>	<u>n</u>	<u>x (mm)</u>	<u>y (mm)</u>
35	242.7	881.2	51	759.2	875.4
36	240.0	865.7	52	761.0	866.8
37	239.3	837.9	53	762.6	838.8
38	242.2	810.0	54	758.1	810.8

AQUARIUM DATA

39	247.4	782.3	55	753.2	782.9
40	255.3	754.5	56	744.8	755.0
41	267.2	726.6	57	734.9	727.0
42	279.3	698.7	58	721.6	699.0
43	295.4	671.0	59	705.4	671.2
44	311.7	643.2	60	688.0	643.3
45	331.8	615.2	61	669.9	615.4
46	352.6	587.3	62	647.6	587.4
47	374.4	559.4	63	625.4	559.5
48	397.4	531.5	64	601.8	531.6
49	418.1	503.6	65	579.7	503.6
50	435.5	475.6	66	564.5	475.6

Exposure 2

Left			Right		
<u>n</u>	<u>x (mm)</u>	<u>y (mm)</u>	<u>n</u>	<u>x (mm)</u>	<u>y (mm)</u>
67	180.9	881.1	88	824.9	867.6
68	178.2	869.4	89	826.9	841.1
69	175.7	841.5	90	826.2	813.2
70	176.8	813.5	91	822.4	785.5
71	178.7	785.6	92	817.1	757.6
72	184.3	757.7	93	810.1	729.7
73	190.5	729.8	94	799.5	701.6
74	200.1	701.8	95	789.2	673.8
75	212.0	673.9	96	776.4	646.0
76	225.2	646.0	97	762.0	618.1
77	239.9	618.1	98	744.4	590.1
78	255.2	590.1	99	728.1	562.2
79	272.6	562.2	100	709.0	534.3
80	290.5	534.3	101	688.8	506.3
81	310.0	506.3	102	668.1	478.4
82	330.1	478.4	103	647.4	450.5
83	351.7	450.5	104	624.9	422.6
84	373.6	422.6	105	601.9	394.6
85	398.6	394.6	106	578.3	366.7
86	420.4	366.7	107	564.5	338.7
87	435.5	338.7			

AQUARIUM DATA

SHOT 5097 - Camera 2  
EXPLOSIVE (PIPE) - WATER INTERFACE POSITIONS

Exposure 1

Left			Right		
<i>n</i>	<i>x</i> (mm)	<i>y</i> (mm)	<i>n</i>	<i>x</i> (mm)	<i>y</i> (mm)
1	359.1	891.2	18	641.1	883.0
2	358.2	863.2	19	639.8	862.7
3	361.2	835.0	20	636.7	834.6
4	365.9	806.8	21	632.2	806.5
5	369.9	778.8	22	627.9	778.4
6	374.7	750.7	23	625.1	750.3
7	377.7	722.5	24	622.4	722.1
8	382.2	694.3	25	618.9	693.9
9	385.2	666.3	26	615.2	666.0
10	388.1	638.2	27	612.7	638.0
11	390.4	610.0	28	610.1	609.9
12	392.3	581.8	29	607.2	581.8
13	394.9	553.7	30	603.1	553.9
14	398.2	525.7	31	599.9	525.9
15	401.6	497.5	32	597.9	497.9
16	411.6	412.9	33	592.4	469.8
17	435.5	269.1	34	590.2	441.9
			35	564.5	269.1

Exposure 2

Left			Right		
<i>n</i>	<i>x</i> (mm)	<i>y</i> (mm)	<i>n</i>	<i>x</i> (mm)	<i>y</i> (mm)
36	380.9	551.0	45	616.1	540.1
37	383.7	522.9	46	612.8	511.9
38	387.9	494.8	47	610.6	483.7
39	389.6	466.6	48	606.6	455.6
40	392.5	438.5	49	603.8	427.6
41	396.1	410.4	50	600.8	399.4
42	400.7	382.2	51	597.5	371.3
43	403.5	354.0	52	594.5	343.3
44	435.5	132.0	53	591.3	315.2
			54	584.7	287.0
			55	564.5	132.0

## SHOCK FRONT POSITIONS

## Exposure 1

Left			Right		
<i>n</i>	x (mm)	y (mm)	<i>n</i>	x (mm)	y (mm)
56	136.9	892.7	79	863.9	886.1
57	132.5	859.8	80	865.9	859.9
58	132.6	831.6	81	866.3	831.7
59	135.7	803.4	82	862.5	803.6
60	139.9	775.4	83	858.2	775.5
61	145.8	747.3	84	852.1	747.4
62	152.6	719.1	85	844.5	719.2
63	162.7	690.9	86	835.6	691.1
64	173.1	662.9	87	824.2	663.0
65	186.6	634.8	88	811.7	634.9
66	200.6	606.6	89	797.6	606.7
67	216.3	578.4	90	781.7	578.5
68	230.7	550.3	91	765.5	550.5
69	250.0	522.3	92	746.9	522.4
70	269.0	494.1	93	728.8	494.2
71	287.5	466.0	94	709.2	466.1
72	308.2	437.8	95	689.6	438.0
73	328.9	409.8	96	668.6	409.9
74	352.0	381.6	97	646.9	381.7
75	374.0	353.4	98	625.6	353.5
76	397.5	325.4	99	602.8	325.5
77	420.9	297.3	100	579.0	297.3
78	435.5	269.0	101	564.5	269.0

## Exposure 2

Left			Right		
<i>n</i>	x (mm)	y (mm)	<i>n</i>	x (mm)	y (mm)
102	73.1	895.9	130	925.7	884.7
103	68.9	863.2	131	928.7	861.5
104	67.6	835.1	132	930.0	833.4
105	67.9	806.9	133	928.4	805.4
106	72.8	778.8	134	925.6	777.3
107	77.9	750.7	135	921.4	749.2
108	83.0	722.6	136	914.6	721.1



## AQUARIUM DATA

109	89.9	694.4	137	906.7	693.1
110	98.8	666.3	138	898.0	665.1
111	108.3	638.2	139	888.2	637.1
112	120.2	610.1	140	876.7	609.0
113	133.3	581.9	141	864.7	581.0
114	147.2	553.8	142	850.1	553.0
115	162.2	525.8	143	836.2	525.1
116	178.4	497.6	144	819.4	496.9
117	195.6	469.4	145	802.6	468.7
118	212.4	441.3	146	785.7	440.7
119	229.8	413.2	147	766.8	412.5
120	247.4	385.0	148	748.1	384.3
121	267.8	356.9	149	727.5	356.3
122	288.1	328.9	150	707.3	328.3
123	308.7	300.7	151	689.4	300.1
124	329.7	272.5	152	668.5	272.1
125	350.6	244.4	153	646.8	244.1
126	374.1	216.3	154	624.9	216.1
127	399.3	188.2	155	601.0	188.1
128	420.7	160.0	156	579.4	160.0
129	435.5	132.0	157	564.5	132.0

AQUARIUM DATA

Material: DBA-1 Shot no.: C-4691

Experimenter: G. F. Lederman Date: April 6, 1977

Charge diameter: 9.84 cm Charge length: 121.9 cm

Initial density: 1.47 g/cm<sup>3</sup> Temperature: 300 K

Confinement: Clay pipe, 1.71-cm wall with 9.84-cm i.d., in water

Booster: One SE-1 detonator, one tetryl pellet, and a 2.5-cm-diam by 10-cm-long Comp B charge

Exposures of image intensifier camera : Three

Time between exposures: 47 and 59  $\mu$ s

Detonation velocity: 4.53 km/s

Notes: DBA-1 is manufactured by Ireco Chemicals, Inc., Salt Lake City, Utah

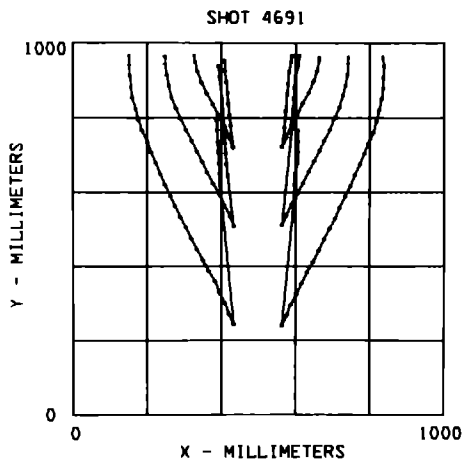

AQUARIUM DATA

SHOT 4691  
EXPLOSIVE (PIPE) - WATER INTERFACE POSITIONS

Exposure 1

Left			Right		
<i>n</i>	<i>x</i> (mm)	<i>y</i> (mm)	<i>n</i>	<i>x</i> (mm)	<i>y</i> (mm)
1	408.3	952.3	9	589.4	964.5
2	410.5	923.2	10	585.9	946.9
3	413.5	894.1	11	582.4	917.9
4	416.0	865.1	12	579.4	888.8
5	418.6	836.1	13	576.4	859.7
6	421.1	807.1	14	573.5	816.1
7	425.4	778.0	15	570.0	772.8
8	432.2	719.8	16	563.1	721.7

Exposure 2

Left			Right		
<i>n</i>	<i>x</i> (mm)	<i>y</i> (mm)	<i>n</i>	<i>x</i> (mm)	<i>y</i> (mm)
17	390.9	935.3	27	610.7	965.6
18	395.8	906.1	28	606.0	936.7
19	401.3	848.0	29	600.5	907.6
20	402.7	819.1	30	597.0	878.5
21	404.5	790.0	31	595.3	849.4
22	409.9	731.8	32	593.6	820.4
23	411.8	702.8	33	591.9	791.4
24	413.6	673.8	34	563.9	509.2
25	416.3	644.7			
26	433.0	507.3			

Exposure 3

Left			Right		
<i>n</i>	<i>x</i> (mm)	<i>y</i> (mm)	<i>n</i>	<i>x</i> (mm)	<i>y</i> (mm)
35	386.3	793.1	43	606.6	765.0
36	388.1	767.0	44	607.4	736.0
37	389.9	734.9	45	606.9	707.0
38	391.2	705.9	46	604.3	678.0
39	392.5	676.9	47	599.0	648.9
40	394.9	647.8	48	597.4	619.8
41	397.3	618.7	49	596.6	590.8
42	433.0	243.3	50	563.3	239.3

## SHOCK FRONT POSITIONS

## Exposure 1

Left			Right		
<i>n</i>	<i>x</i> (mm)	<i>y</i> (mm)	<i>n</i>	<i>x</i> (mm)	<i>y</i> (mm)
51	326.9	967.5	61	663.9	962.5
52	328.7	952.2	62	663.0	954.2
53	334.4	923.2	63	657.6	925.1
54	345.9	894.1	64	647.6	896.0
55	360.7	865.1	65	634.3	866.9
56	376.2	836.1	66	618.3	838.0
57	391.8	807.0	67	604.3	808.9
58	407.5	778.0	68	588.4	779.9
59	421.3	748.9	69	574.7	750.8
60	432.2	719.8	70	563.1	721.7

## Exposure 2

Left			Right		
<i>n</i>	<i>x</i> (mm)	<i>y</i> (mm)	<i>n</i>	<i>x</i> (mm)	<i>y</i> (mm)
71	248.9	965.0	88	741.4	961.7
72	248.8	943.1	89	741.9	945.0
73	252.5	914.0	90	740.0	915.0
74	257.5	884.9	91	734.9	886.8
75	265.8	855.8	92	727.4	857.7
76	277.1	826.9	93	718.2	828.8
77	290.3	797.8	94	705.1	799.7
78	304.7	768.7	95	692.7	770.6
79	319.8	739.7	96	677.8	741.6
80	334.0	710.7	97	664.6	712.5
81	349.1	681.7	98	649.6	683.6
82	362.0	652.6	99	634.2	654.5
83	378.6	623.5	100	619.4	625.4
84	394.3	594.4	101	604.6	596.4
85	408.6	565.5	102	588.3	567.4
86	422.7	536.4	103	574.8	538.3
87	433.0	507.3	104	563.9	509.2

AQUARIUM DATA

Exposure 3

Left			Right		
<i>n</i>	<i>x</i> (mm)	<i>y</i> (mm)	<i>n</i>	<i>x</i> (mm)	<i>y</i> (mm)
105	152.2	965.7	131	835.4	960.9
106	152.2	940.4	132	837.9	936.5
107	153.5	911.3	133	837.3	907.4
108	156.5	882.2	134	836.9	878.3
109	160.5	853.2	135	831.8	849.2
110	168.3	824.2	136	825.8	820.3
111	176.3	795.2	137	817.5	791.2
112	186.4	766.1	138	809.9	762.1
113	199.2	737.0	139	797.3	733.0
114	210.3	708.0	140	785.4	704.1
115	223.6	678.9	141	773.2	675.0
116	235.4	649.9	142	760.5	645.9
117	248.1	620.8	143	747.8	616.8
118	261.2	591.8	144	733.3	587.8
119	275.7	562.8	145	718.9	558.9
120	289.4	533.7	146	706.1	529.8
121	302.8	504.6	147	691.7	500.6
122	317.5	475.6	148	676.8	471.7
123	333.0	446.6	149	662.9	442.7
124	350.0	417.5	150	648.7	413.6
125	365.6	388.5	151	631.8	384.5
126	382.8	359.4	152	617.3	355.4
127	395.0	330.4	153	602.8	326.4
128	409.6	301.4	154	586.4	297.5
129	420.1	272.3	155	576.4	268.3
130	433.0	243.3	156	563.3	239.3

AQUARIUM DATA

**Material:** DBA-1    **Shot no.:** C-4663

**Experimenter:** B. G. Craig    **Date:** January 21, 1977

**Charge diameter:** 19.8 cm    **Charge length:** 168.2 cm

**Initial density:** 1.496 g/cm<sup>3</sup>    **Temperature:** 298 K

**Confinement:** Clay pipe, 22.7-mm-thick wall, in water

**Booster:** One SE-1 detonator, one tetryl pellet, and a 20-cm-diam by 2.5-cm-long Comp B charge

**Exposures of image intensifier camera:** Two

**Time between exposures:** 103.4  $\mu$ s    **Detonation velocity:** 4.81 km/s

**Notes:** ANFO is Gulf N-C-N 100 manufactured by Gulf Oil Chemical Co., Merriam, Kansas

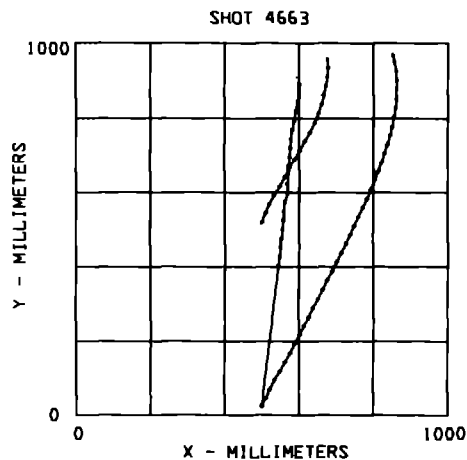

AQUARIUM DATA

SHOT 4663  
EXPLOSIVE (PIPE) - WATER INTERFACE POSITIONS

Exposure 2

Right		
<i>n</i>	<i>x</i> (mm)	<i>y</i> (mm)
1	601.1	890.4
2	599.2	866.0
3	595.8	841.5
4	590.8	817.1
5	586.0	792.8
6	581.4	768.4
7	577.6	744.0
8	576.0	719.5
9	574.7	695.1
10	573.8	670.8
11	568.0	622.0
12	569.5	597.6
13	562.3	573.2
14	560.3	548.7
15	558.9	524.5
16	557.2	500.0
17	554.0	475.5
18	550.8	451.2
19	548.9	426.9
20	545.8	402.4
21	500.0	22.7

SHOCK FRONT POSITIONS

Exposure 1

Right		
<i>n</i>	<i>x</i> (mm)	<i>y</i> (mm)
22	676.9	956.4
23	679.0	934.7
24	676.8	910.4
25	672.9	886.0
26	666.9	861.5
27	660.0	837.1
28	651.2	812.7

AQUARIUM DATA

29	640.9	788.4
30	629.4	764.0
31	616.8	739.5
32	602.6	715.1
33	588.4	690.7
34	575.2	666.4
35	561.3	642.0
36	548.4	617.5
37	533.8	593.1
38	519.9	568.7
39	509.4	544.4
40	500.0	520.0

Exposure 2

Right

<u>n</u>	<u>x (mm)</u>	<u>y (mm)</u>
41	851.0	968.3
42	857.3	949.9
43	861.1	925.5
44	862.9	901.2
45	862.7	876.7
46	861.3	852.3
47	859.3	827.9
48	855.4	803.5
49	851.1	779.1
50	845.1	754.7
51	838.8	730.3
52	830.6	705.9
53	822.6	681.5
54	812.9	657.1
55	803.0	632.7
56	793.0	583.9
57	783.0	583.9
58	771.5	559.5
59	759.8	535.1
60	748.7	510.7
61	737.8	486.2
62	725.9	461.8
63	714.0	437.5
64	701.6	413.1



## AQUARIUM DATA

65	689.4	388.7
66	676.7	364.2
67	664.9	339.9
68	652.3	315.5
69	639.0	291.1
70	627.4	266.7
71	614.0	242.3
72	601.6	217.9
73	588.6	193.5
74	576.0	169.1
75	564.1	144.7
76	550.0	120.3
77	535.5	95.9
78	522.8	71.6
79	509.9	47.1
80	500.0	22.7

AQUARIUM DATA

Material: Destex Shot no.: C-4716

Experimenter: B. G. Craig Date: August 4, 1977

Charge diameter: 10.3 cm Charge length: 118.7 cm

Initial density: 1.696 g/cm<sup>3</sup> Temperature: 295 K

Confinement: Bare charge in water

Booster: One 1E23 detonator, one P-040 lens, and a 11.4-cm-diam by 10.5-cm-long TNT charge

Exposures of image intensifier camera: One

Detonation velocity: 6.63 km/s

Notes: Destex composition (74.8 wt% TNT/18.7 wt% aluminum/4.7 wt% wax/1.8 wt% graphite)

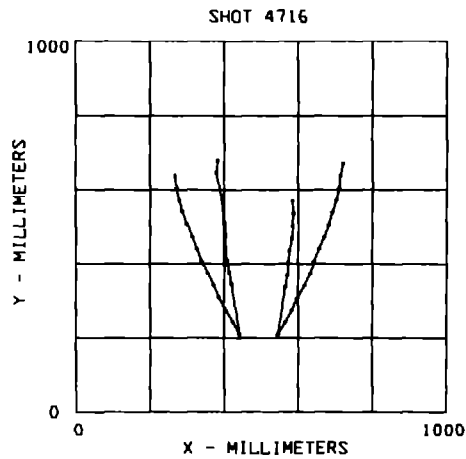

AQUARIUM DATA

SHOT 4716  
EXPLOSIVE (PIPE) - WATER INTERFACE POSITIONS

Exposure 1

Left			Right		
<i>n</i>	<i>x</i> (mm)	<i>y</i> (mm)	<i>n</i>	<i>x</i> (mm)	<i>y</i> (mm)
1	383.1	676.6	11	585.0	565.9
2	380.0	645.7	12	588.5	532.8
3	397.7	541.4	13	585.7	499.8
4	401.7	508.4	14	583.4	466.8
5	403.6	475.4	15	577.0	433.6
6	404.0	442.2	16	574.0	400.5
7	408.4	409.1	17	570.7	367.5
8	413.3	376.0	18	565.0	334.4
9	419.5	343.0	19	544.3	207.7
10	441.4	209.5			

SHOCK FRONT POSITIONS

Exposure 1

Left			Right		
<i>n</i>	<i>x</i> (mm)	<i>y</i> (mm)	<i>n</i>	<i>x</i> (mm)	<i>y</i> (mm)
20	268.6	638.1	34	722.3	670.9
21	271.3	605.2	35	715.7	637.8
22	277.9	572.1	36	710.2	604.8
23	288.1	539.2	37	702.8	571.7
24	299.5	506.3	38	693.4	538.6
25	312.7	473.3	39	683.9	505.5
26	326.7	440.3	40	670.5	472.5
27	340.6	407.4	41	657.2	439.4
28	354.5	374.5	42	643.3	406.3
29	371.0	341.5	43	632.2	373.2
30	387.0	308.6	44	616.3	340.1
31	403.1	275.4	45	597.8	307.0
32	423.2	242.6	46	581.3	273.9
33	441.4	209.5	47	564.7	240.9
			48	544.3	207.7

AQUARIUM DATA

**Material:** Nitromethane      **Shot no.:** C-4868

**Experimenter:** J. B. Ramsay      **Date:** January 24, 1979

**Charge diameter:** 2.5 cm      **Charge length:** 58.4 cm

**Initial density:** 1.13 g/cm<sup>3</sup>      **Temperature:** 299 K

**Confinement:** 5-mm Teflon in water

**Booster:** One SE-1 detonator, one 1.3-cm-diam by 1.3-cm-long PBX-9407 pellet, and a 2.5- by 2.5-cm PBX-9404 pellet

**Exposures of image intensifier camera:** Two

**Time between exposures:** 37.29  $\mu$ s      **Detonation velocity:** 6.2 km/s

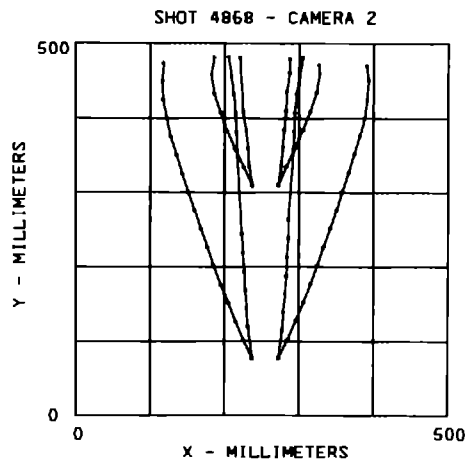
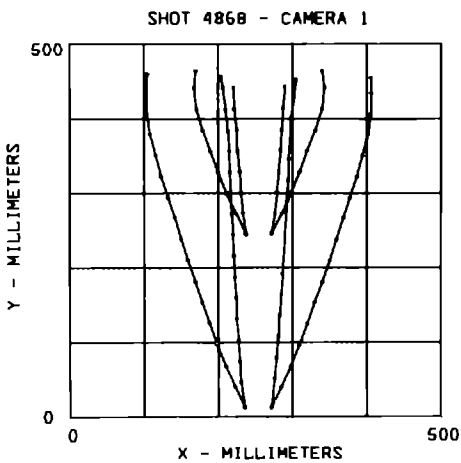

AQUARIUM DATA

SHOT 4868 - Camera 1  
EXPLOSIVE (PIPE) - WATER INTERFACE POSITIONS

Exposure 1

Left			Right		
<i>n</i>	<i>x (mm)</i>	<i>y (mm)</i>	<i>n</i>	<i>x (mm)</i>	<i>y (mm)</i>
1	220.9	441.1	9	290.2	441.7
2	221.5	412.9	10	287.3	413.5
3	225.0	384.7	11	285.6	385.4
4	226.2	356.6	12	283.8	357.2
5	228.9	328.4	13	281.3	329.0
6	230.9	300.3	14	279.2	300.9
7	233.3	272.1	15	276.4	272.7
8	237.4	243.9	16	271.9	244.6

Exposure 2

Left			Right		
<i>n</i>	<i>x (mm)</i>	<i>y (mm)</i>	<i>n</i>	<i>x (mm)</i>	<i>y (mm)</i>
17	204.2	454.3	34	305.3	450.5
18	206.6	440.1	35	302.3	429.2
19	210.1	411.9	36	298.6	401.0
20	213.5	383.7	37	295.0	344.6
21	214.7	355.6	38	293.9	316.5
22	215.6	327.4	39	292.4	288.3
23	216.8	299.3	40	286.6	191.8
24	218.1	271.1	41	284.6	163.6
25	219.7	243.0	42	282.8	135.4
26	221.2	214.8	43	280.7	107.3
27	222.4	186.7	44	278.6	79.1
28	223.9	158.6	45	276.1	51.0
29	225.4	130.5	46	271.4	12.2
30	227.4	102.4			
31	229.1	74.3			
32	230.7	46.2			
33	235.8	12.9			

## SHOCK FRONT POSITIONS

## Exposure 1

Left			Right		
<i>n</i>	<i>x</i> (mm)	<i>y</i> (mm)	<i>n</i>	<i>x</i> (mm)	<i>y</i> (mm)
47	169.7	463.5	56	340.2	463.6
48	167.4	441.1	57	343.3	441.6
49	171.2	412.9	58	339.6	413.4
50	179.3	384.7	59	331.2	385.2
51	189.3	356.6	60	320.2	357.1
52	200.2	328.4	61	309.8	329.1
53	211.0	300.3	62	298.4	301.0
54	224.5	272.1	63	285.5	272.7
55	237.4	243.9	64	271.9	244.6

## Exposure 2

Left			Right		
<i>n</i>	<i>x</i> (mm)	<i>y</i> (mm)	<i>n</i>	<i>x</i> (mm)	<i>y</i> (mm)
65	105.3	459.1	82	405.5	454.1
66	103.1	435.3	83	406.9	434.5
67	104.3	407.1	84	406.0	406.3
68	108.7	379.0	85	401.9	378.2
69	115.6	350.8	86	394.5	350.1
70	123.7	322.7	87	386.3	321.9
71	132.1	294.5	88	377.3	293.8
72	141.4	266.3	89	368.3	265.6
73	150.3	238.2	90	359.1	237.5
74	159.4	210.0	91	349.8	209.3
75	168.8	181.9	92	340.0	181.2
76	178.4	153.7	93	330.1	153.0
77	188.3	125.6	94	319.7	124.8
78	198.7	97.4	95	308.8	96.7
79	209.9	69.3	96	297.3	68.5
80	222.4	41.2	97	284.6	40.4
81	235.8	12.9	98	271.4	12.2

AQUARIUM DATA

SHOT 4868 - Camera 2  
 EXPLOSIVE (PIPE) - WATER INTERFACE POSITIONS

Exposure 1

Left			Right		
<i>n</i>	<i>x</i> (mm)	<i>y</i> (mm)	<i>n</i>	<i>x</i> (mm)	<i>y</i> (mm)
1	221.2	479.2	7	287.8	477.7
2	225.3	408.3	8	287.2	459.1
3	229.3	383.5	9	283.4	434.2
4	231.4	358.6	10	282.6	409.4
5	233.5	333.9	11	279.7	384.5
6	237.5	309.1	12	278.0	359.7
			13	275.6	334.9
			14	272.4	309.9

Exposure 2

Left			Right		
<i>n</i>	<i>x</i> (mm)	<i>y</i> (mm)	<i>n</i>	<i>x</i> (mm)	<i>y</i> (mm)
15	205.6	480.2	28	305.4	478.9
16	209.3	455.4	29	300.5	456.2
17	212.9	430.5	30	296.5	431.3
18	214.6	405.6	31	294.3	406.5
19	216.1	380.8	32	293.0	381.6
20	216.7	355.8	33	292.4	356.7
21	223.3	243.1	34	286.1	262.2
22	225.4	218.2	35	285.5	237.4
23	226.8	193.4	36	284.5	212.6
24	228.0	168.5	37	283.3	187.8
25	230.0	143.7	38	281.6	163.0
26	231.6	118.8	39	279.2	138.2
27	237.6	77.1	40	277.8	113.4
			41	272.6	77.9

## SHOCK FRONT POSITIONS

## Exposure 1

Left			Right		
<i>n</i>	<i>x</i> (mm)	<i>y</i> (mm)	<i>n</i>	<i>x</i> (mm)	<i>y</i> (mm)
42	185.5	480.0	50	326.4	470.2
43	182.1	457.9	51	327.8	459.1
44	186.2	433.1	52	323.6	434.2
45	194.2	408.4	53	315.4	409.4
46	203.7	383.6	54	305.4	384.5
47	214.3	358.7	55	294.7	359.6
48	226.0	334.0	56	283.0	334.8
49	237.5	309.1	57	272.4	309.9

## Exposure 2

Left			Right		
<i>n</i>	<i>x</i> (mm)	<i>y</i> (mm)	<i>n</i>	<i>x</i> (mm)	<i>y</i> (mm)
58	118.5	472.8	75	391.1	469.2
59	116.3	449.2	76	393.5	450.8
60	117.5	424.4	77	391.6	425.9
61	122.1	399.6	78	388.0	401.0
62	127.6	374.7	79	381.5	376.2
63	135.5	349.9	80	373.9	351.3
64	143.3	325.1	81	366.6	326.5
65	151.6	300.3	82	358.4	301.6
66	159.6	275.5	83	350.5	276.8
67	168.2	250.7	84	342.1	251.9
68	177.5	225.9	85	333.2	227.0
69	186.1	201.2	86	324.7	202.2
70	194.9	176.3	87	315.6	177.4
71	204.6	151.6	88	306.4	152.5
72	214.6	126.7	89	295.7	127.7
73	225.8	101.9	90	285.2	102.8
74	237.6	77.1	91	272.6	77.9



AQUARIUM DATA

**Material:** Nitromethane    **Shot no.:** C-5017

**Experimenter:** S. Goldstein    **Date:** June 2, 1980

**Charge diameter:** 2.54 cm    **Charge length:** 31.8 cm

**Initial density:** 1.13 g/cm<sup>3</sup>    **Temperature:** 296 K

**Confinement:** 4.8-mm Teflon in water

**Booster:** One RP-1/PT detonator, one PBX-9407 pellet, and one 2.5-cm-diam by 2.5-cm-long PBX-9404-03 pellet

**Exposures of image intensifier camera:** Two

**Time between exposures:** 24.12  $\mu$ s    **Detonation velocity:** 6.2 km/s

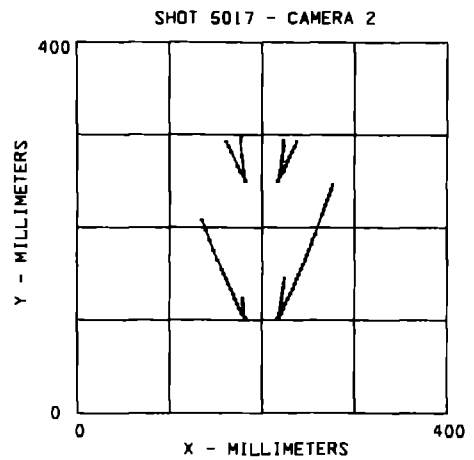
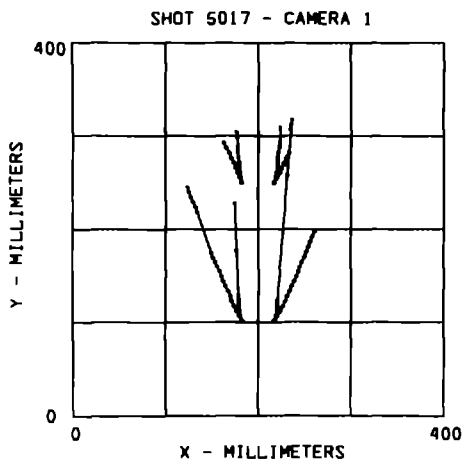

SHOT 5017 - Camera 1  
EXPLOSIVE (PIPE) - WATER INTERFACE POSITIONS

Exposure 1

Left			Right		
<i>n</i>	<i>x</i> (mm)	<i>y</i> (mm)	<i>n</i>	<i>x</i> (mm)	<i>y</i> (mm)
1	176.7	303.5	11	224.2	308.8
2	177.3	298.2	12	223.2	292.8
3	178.2	287.5	13	222.8	287.5
4	178.2	282.2	14	222.2	282.1
5	178.7	276.8	15	221.6	276.7
6	179.4	271.5	16	221.2	271.4
7	180.0	266.2	17	220.4	266.1
8	180.8	260.8	18	219.8	260.7
9	181.5	255.5	19	218.9	255.4
10	182.5	250.1	20	217.5	250.0

Exposure 2

Left			Right		
<i>n</i>	<i>x</i> (mm)	<i>y</i> (mm)	<i>n</i>	<i>x</i> (mm)	<i>y</i> (mm)
21	174.5	226.7	29	236.5	316.6
22	176.9	176.4	30	236.0	311.2
23	178.7	127.9	31	235.3	305.9
24	179.1	122.6	32	231.9	268.5
25	179.6	117.2	33	231.0	257.6
26	180.2	111.9	34	220.9	122.5
27	180.8	106.5	35	220.5	117.2
28	182.5	101.2	36	220.1	111.8
			37	219.5	106.5
			38	217.5	101.1

AQUARIUM DATA

SHOCK FRONT POSITIONS

Exposure 1

Left			Right		
<i>n</i>	<i>x</i> (mm)	<i>y</i> (mm)	<i>n</i>	<i>x</i> (mm)	<i>y</i> (mm)
39	162.7	292.9	48	233.5	282.1
40	165.3	287.6	49	230.7	276.7
41	168.5	282.2	50	227.9	271.4
42	170.8	276.9	51	225.6	266.1
43	173.7	271.5	52	223.3	260.7
44	175.8	266.2	53	220.2	255.4
45	178.3	260.8	54	217.5	250.0
46	180.7	255.5			
47	182.5	249.9			

Exposure 2

Left			Right		
<i>n</i>	<i>x</i> (mm)	<i>y</i> (mm)	<i>n</i>	<i>x</i> (mm)	<i>y</i> (mm)
55	123.8	245.6	76	260.5	197.3
56	125.5	240.2	77	258.2	192.2
57	127.6	234.9	78	255.7	186.6
58	129.6	229.5	79	253.7	181.3
59	131.8	224.2	80	251.7	175.9
60	133.9	218.8	81	249.7	170.6
61	149.3	176.1	82	247.4	165.2
62	151.4	170.7	83	245.2	159.9
63	153.7	165.4	84	243.2	154.6
64	155.7	160.0	85	241.1	149.2
65	157.8	154.7	86	238.6	143.9
66	160.2	149.3	87	236.0	138.5
67	162.3	143.9	88	233.7	133.2
68	164.4	138.6	89	231.6	127.8
69	167.0	133.3	90	229.0	122.5
70	169.7	127.9	91	226.4	117.1
71	171.6	122.6	92	223.7	111.8
72	174.2	117.2	93	220.9	106.4
73	176.9	111.9	94	217.5	101.1
74	179.8	106.5			
75	182.5	101.2			

**SHOT 5017 - Camera 2**  
**EXPLOSIVE (PIPE) - WATER INTERFACE POSITIONS**

Exposure 1

Left			Right		
<i>n</i>	<i>x</i> (mm)	<i>y</i> (mm)	<i>n</i>	<i>x</i> (mm)	<i>y</i> (mm)
1	177.0	298.0	7	223.5	292.8
2	176.9	292.6	8	223.1	287.4
3	178.3	276.7	9	222.5	282.1
4	179.1	271.4	10	221.9	276.7
5	180.3	260.7	11	221.4	271.4
6	182.5	250.0	12	220.9	266.1
			13	220.1	260.7
			14	219.0	255.4
			15	217.5	250.0

Exposure 2

Left			Right		
<i>n</i>	<i>x</i> (mm)	<i>y</i> (mm)	<i>n</i>	<i>x</i> (mm)	<i>y</i> (mm)
16	179.2	122.6	21	224.0	144.0
17	179.4	117.2	22	223.4	138.6
18	179.8	111.9	23	222.6	133.3
19	180.3	106.5	24	221.9	128.0
20	182.5	101.2	25	221.2	122.6
			26	220.7	117.2
			27	220.0	111.9
			28	219.1	106.5
			29	217.5	101.2

**SHOCK FRONT POSITIONS**

Exposure 1

Left			Right		
<i>n</i>	<i>x</i> (mm)	<i>y</i> (mm)	<i>n</i>	<i>x</i> (mm)	<i>y</i> (mm)
30	161.1	292.8	36	237.6	292.8
31	163.9	287.4	37	235.4	287.4
32	166.4	282.1	38	232.5	282.1
33	174.3	266.1	39	230.2	276.7

AQUARIUM DATA

34	176.7	260.7	40	227.5	271.4
35	182.5	250.0	41	225.6	266.1
			42	223.6	260.7
			43	217.5	250.0

Exposure 2

Left			Right		
<i>n</i>	<i>x</i> (mm)	<i>y</i> (mm)	<i>n</i>	<i>x</i> (mm)	<i>y</i> (mm)
44	135.3	208.1	60	276.6	245.5
45	139.3	197.4	61	274.6	240.2
46	143.4	186.7	62	272.5	234.8
47	147.5	176.0	63	270.7	229.5
48	152.0	165.3	64	268.6	224.1
49	156.3	154.6	65	266.5	218.8
50	158.6	149.3	66	264.4	213.4
51	161.3	143.9	67	257.0	192.0
52	163.5	138.6	68	254.9	186.7
53	166.0	133.3	69	253.0	181.4
54	168.4	127.9	70	250.9	176.0
55	170.6	122.6	71	248.8	170.7
56	173.2	117.2	72	246.4	165.3
57	175.9	111.9	73	244.3	160.0
58	178.6	106.5	74	242.2	154.6
59	182.5	101.2	75	239.9	149.3
			76	237.6	143.9
			77	235.3	138.6
			78	233.0	133.3
			79	230.4	127.9
			80	228.0	122.6
			81	225.6	117.2
			82	223.0	111.9
			83	220.6	106.5
			84	217.5	101.2

AQUARIUM DATA

Material: PBX 9404 Shot no.: C-4728

Experimenter: B. G. Craig Date: October 7, 1977

Charge diameter: 2.54 cm Charge length: 30.3 cm

Initial density: 1.84 g/cm<sup>3</sup> Temperature: 296 K

Confinement: Bare charge in water

Booster: One SE-1 detonator and one tetryl pellet

Exposures of image intensifier camera: Two

Time between exposures: 15.86  $\mu$ s Detonation velocity: 8.79 km/s

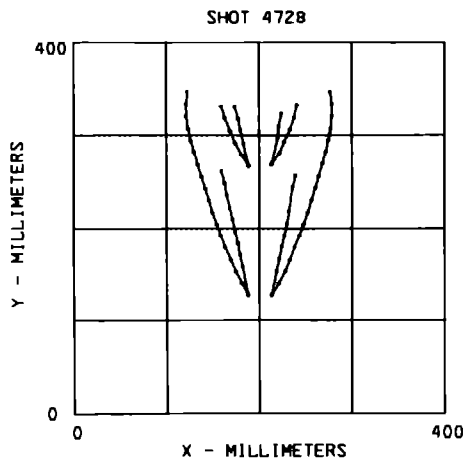

AQUARIUM DATA

SHOT 4728  
EXPLOSIVE (PIPE) - WATER INTERFACE POSITIONS

Exposure 1

Left			Right		
<i>n</i>	<i>x</i> (mm)	<i>y</i> (mm)	<i>n</i>	<i>x</i> (mm)	<i>y</i> (mm)
1	173.7	330.2	6	224.2	322.4
2	177.5	317.4	7	221.6	309.5
3	180.3	304.5	8	219.7	296.6
4	182.8	291.6	9	213.6	267.8
5	188.4	266.4			

Exposure 2

Left			Right		
<i>n</i>	<i>x</i> (mm)	<i>y</i> (mm)	<i>n</i>	<i>x</i> (mm)	<i>y</i> (mm)
10	159.4	260.6	20	239.2	256.2
11	162.8	247.7	21	236.1	243.4
12	165.6	234.9	22	232.1	217.6
13	167.9	222.0	23	229.9	204.8
14	171.4	209.2	24	227.1	192.0
15	174.2	196.3	25	223.9	179.1
16	176.6	183.5	26	221.6	166.3
17	179.3	170.6	27	218.8	153.4
18	181.7	157.8	28	213.5	127.7
19	188.3	127.7			

SHOCK FRONT POSITIONS

Exposure 1

Left			Right		
<i>n</i>	<i>x</i> (mm)	<i>y</i> (mm)	<i>n</i>	<i>x</i> (mm)	<i>y</i> (mm)
29	159.6	330.6	35	240.6	332.0
30	163.5	317.8	36	237.9	319.2
31	168.7	304.9	37	233.1	306.3
32	174.1	292.1	38	227.6	293.5
33	180.7	279.3	39	221.7	280.6
34	188.4	266.4	40	213.6	267.8

## Exposure 2

Left			Right		
<i>n</i>	<i>x</i> (mm)	<i>y</i> (mm)	<i>n</i>	<i>x</i> (mm)	<i>y</i> (mm)
41	122.6	346.1	59	276.4	346.1
42	121.0	333.3	60	278.6	333.3
43	121.5	320.4	61	278.6	320.4
44	123.3	307.6	62	277.2	307.5
45	126.2	294.7	63	274.7	294.7
46	130.0	281.9	64	271.7	281.9
47	133.5	269.0	65	268.2	269.0
48	137.2	256.2	66	264.5	256.1
49	141.4	243.3	67	260.5	243.3
50	145.3	230.5	68	256.7	230.5
51	149.5	217.6	69	252.4	217.6
52	153.9	204.8	70	247.9	204.8
53	158.7	192.0	71	243.2	192.0
54	163.6	179.1	72	238.3	179.1
55	169.0	166.2	73	233.4	166.2
56	174.7	153.4	74	227.7	153.4
57	181.2	140.5	75	221.1	140.5
58	188.3	127.7	76	213.5	127.7



**AQUARIUM DATA**

**Material:** PBX 9404    **Shot no.:** C-4785

**Experimenter:** T. E. Gould    **Date:** May 15, 1978

**Charge diameter:** 2.5 cm    **Charge length:** 35.6 cm

**Initial density:** 1.84 g/cm<sup>3</sup>    **Temperature:** 303 K

**Confinement:** Bare charge in water

**Booster:** One SE-1 detonator and one 1.3-cm-diam by 1.3-cm-long PBX-9407 pellet

**Exposures of image intensifier camera:** Two

**Time between exposures:** 14.40  $\mu$ s

**Detonation velocity:** 8.806 km/s

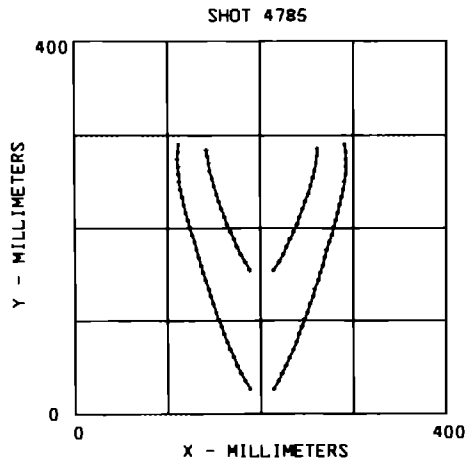

## SHOT 4785

## SHOCK FRONT POSITIONS

## Exposure 1

Left			Right		
<i>n</i>	<i>x</i> (mm)	<i>y</i> (mm)	<i>n</i>	<i>x</i> (mm)	<i>y</i> (mm)
1	188.6	154.9	18	214.0	154.9
2	183.3	163.1	19	219.8	163.1
3	178.9	171.3	20	224.4	171.3
4	174.9	179.5	21	228.0	179.5
5	171.3	187.7	22	232.0	187.7
6	167.7	195.9	23	235.2	195.9
7	164.3	204.1	24	239.0	204.1
8	161.1	212.3	25	242.0	212.3
9	158.1	220.5	26	245.0	220.5
10	155.1	228.7	27	248.3	228.7
11	152.4	236.9	28	251.1	236.9
12	149.8	245.1	29	253.8	245.1
13	147.7	253.3	30	256.0	253.3
14	145.5	261.5	31	258.2	261.5
15	143.9	269.7	32	259.8	269.7
16	142.5	277.9	33	260.5	277.9
17	142.0	285.0	34	261.3	286.1

## Exposure 2

Left			Right		
<i>n</i>	<i>x</i> (mm)	<i>y</i> (mm)	<i>n</i>	<i>x</i> (mm)	<i>y</i> (mm)
35	188.7	28.3	68	214.0	28.3
36	183.2	36.5	69	219.4	36.5
37	178.8	44.7	70	223.4	44.7
38	174.7	52.9	71	227.6	52.9
39	171.0	61.1	72	231.3	61.1
40	167.3	69.3	73	235.0	69.3
41	164.2	77.5	74	238.5	77.5
42	160.7	85.7	75	241.6	85.7
43	157.9	93.9	76	244.7	93.9
44	154.7	102.1	77	247.6	102.1
45	152.0	110.3	78	250.6	110.3
46	149.4	118.5	79	253.6	118.5

## AQUARIUM DATA

47	146.4	126.7	80	256.4	126.7
48	143.9	134.9	81	258.9	134.9
49	141.2	143.1	82	261.7	143.1
50	138.8	151.3	83	264.2	151.3
51	136.3	159.5	84	267.0	159.5
52	133.6	167.7	85	269.2	167.7
53	131.4	175.9	86	274.6	175.9
54	129.0	184.1	87	274.2	184.1
55	126.4	192.3	88	276.5	192.3
56	124.1	200.5	89	278.8	200.5
57	121.9	208.7	90	281.0	208.7
58	119.6	216.9	91	283.3	216.9
59	117.6	225.1	92	285.4	225.1
60	115.7	233.3	93	287.3	233.3
61	114.1	241.5	94	289.0	241.5
62	112.8	249.7	95	290.4	249.7
63	111.8	257.9	96	291.7	257.9
64	111.0	266.1	97	292.2	266.1
65	110.5	274.3	98	292.2	274.3
66	111.0	282.5	99	292.2	282.5
67	111.9	290.7	100	290.9	290.7

AQUARIUM DATA

Material: PBX 9404 Shot no.: C-4981

Experimenter: S. Goldstein Date: February 13, 1980

Charge diameter: 2.6 cm Charge length: 30.5 cm

Initial density: 1.84 g/cm<sup>3</sup> Temperature: 291 K

Confinement: Bare charge in water

Booster: One SE-1 detonator and one PBX-9407 pellet

Exposures of image intensifier camera: Two

Time between exposures: 12.98  $\mu$ s Detonation velocity: 8.54 km/s

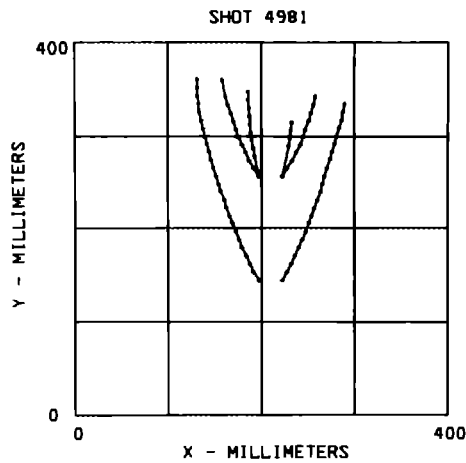

AQUARIUM DATA

SHOT 4981  
EXPLOSIVE (PIPE) - WATER INTERFACE POSITIONS

Exposure 1

Left			Right		
<i>n</i>	<i>x</i> (mm)	<i>y</i> (mm)	<i>n</i>	<i>x</i> (mm)	<i>y</i> (mm)
1	185.9	346.4	11	232.6	313.7
2	186.0	337.8	12	231.4	305.1
3	186.5	329.2	13	230.5	296.5
4	187.3	320.6	14	229.5	287.9
5	187.9	312.1	15	222.8	255.9
6	188.8	303.4			
7	189.7	294.8			
8	191.1	286.2			
9	192.9	277.6			
10	197.4	255.9			

SHOCK FRONT POSITIONS

Exposure 1

Left			Right		
<i>n</i>	<i>x</i> (mm)	<i>y</i> (mm)	<i>n</i>	<i>x</i> (mm)	<i>y</i> (mm)
16	158.3	359.2	28	258.1	342.0
17	161.5	342.0	29	256.3	333.3
18	163.9	333.4	30	253.1	324.8
19	167.0	324.8	31	250.6	316.2
20	169.9	316.2	32	247.6	307.6
21	172.8	307.6	33	244.7	298.9
22	175.5	299.0	34	241.7	290.3
23	179.0	290.3	35	237.4	281.7
24	183.4	281.7	36	233.1	273.1
25	186.9	273.2	37	227.5	264.5
26	192.0	264.5	38	222.8	255.9
27	197.4	255.9			

## Exposure 2

Left			Right		
<i>n</i>	<i>x</i> (mm)	<i>y</i> (mm)	<i>n</i>	<i>x</i> (mm)	<i>y</i> (mm)
39	131.6	360.2	65	289.4	334.2
40	131.0	351.6	66	287.6	325.6
41	131.2	343.0	67	285.7	317.0
42	132.4	334.4	68	283.2	308.4
43	133.6	325.8	69	280.9	299.8
44	135.1	317.2	70	278.7	291.2
45	137.3	308.6	71	276.2	282.6
46	139.2	299.9	72	273.6	274.0
47	141.5	291.3	73	270.9	265.4
48	144.2	282.7	74	268.3	256.8
49	146.3	274.1	75	265.5	248.2
50	148.9	265.5	76	263.1	239.6
51	151.0	256.9	77	260.1	231.0
52	154.2	248.3	78	256.9	222.3
53	156.7	239.7	79	254.0	213.7
54	159.8	231.1	80	250.7	205.2
55	162.9	222.4	81	247.9	196.5
56	165.7	213.8	82	244.1	187.9
57	169.1	205.2	83	240.3	179.3
58	172.5	196.6	84	236.2	170.8
59	175.9	188.0	85	232.1	162.2
60	179.4	179.4	86	227.6	153.6
61	183.8	170.8	87	222.8	145.0
62	188.0	162.2			
63	192.2	153.6			
64	197.4	145.0			

**AQUARIUM DATA**

**Material:** PBX 9404      **Shot no.:** C-4769

**Experimenter:** T. E. Gould      **Date:** April 11, 1978

**Charge diameter:** 2.54 cm      **Charge length:** 32.80 cm

**Initial density:** 1.844 g/cm<sup>3</sup>      **Temperature:** Unknown ambient

**Confinement:** Bare charge in water

**Booster:** One SE-1 detonator and one PBX-9407 pellet

**Exposures of image intensifier camera:** Two

**Time between exposures:** Camera 1, 17.28  $\mu$ s

**Detonation velocity:** 8.77 km/s

**Notes:** Bubble positions were unobservable

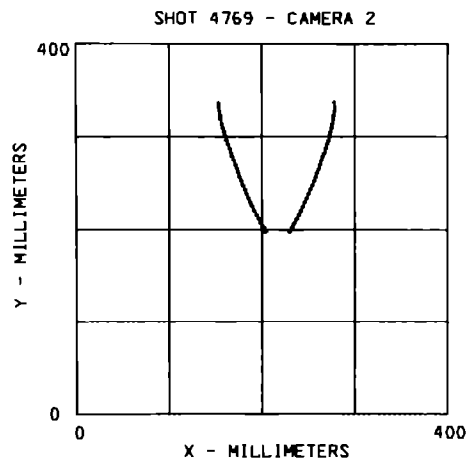
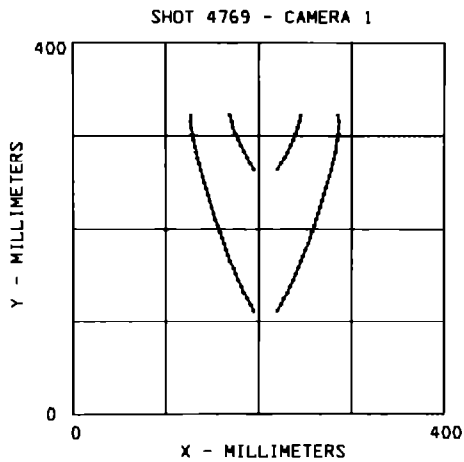

SHOT 4769 - Camera 1  
SHOCK FRONT POSITIONS

## Exposure 1

Left			Right		
<i>n</i>	x (mm)	y (mm)	<i>n</i>	x (mm)	y (mm)
1	168.6	322.5	11	245.3	322.2
2	170.4	316.0	12	244.2	315.7
3	171.8	309.4	13	242.3	309.1
4	174.4	302.8	14	239.7	302.5
5	177.9	296.3	15	237.2	296.0
6	180.9	289.8	16	234.2	289.5
7	184.0	283.2	17	231.3	282.9
8	187.6	276.7	18	228.2	276.4
9	190.8	270.1	19	223.9	269.8
10	194.8	263.5	20	220.2	263.2

## Exposure 2

Left			Right		
<i>n</i>	x (mm)	y (mm)	<i>n</i>	x (mm)	y (mm)
21	127.3	321.7	54	285.6	321.9
22	126.7	315.1	55	286.4	315.4
23	127.1	308.5	56	286.2	308.8
24	128.7	302.1	57	285.7	302.2
25	129.7	295.4	58	284.8	295.7
26	131.0	288.9	59	283.5	289.1
27	132.8	282.4	60	282.6	282.5
28	134.2	275.8	61	281.3	276.0
29	136.0	269.3	62	279.4	269.4
30	137.6	262.7	63	277.7	262.8
31	139.4	256.1	64	275.8	256.3
32	141.3	249.6	65	273.8	249.6
33	143.3	243.1	66	272.0	243.1
34	145.3	236.5	67	270.1	236.6
35	147.3	230.0	68	268.2	230.0
36	149.4	223.4	69	266.2	223.5
37	151.3	216.8	70	264.2	216.9
38	153.6	210.3	71	261.9	210.4
39	155.7	203.7	72	259.7	203.8
40	157.9	197.2	73	257.4	197.2



AQUARIUM DATA

41	160.4	190.6	74	255.0	190.7
42	162.6	184.1	75	253.0	184.1
43	164.9	177.5	76	250.4	177.5
44	167.5	171.0	77	247.9	171.0
45	169.6	164.4	78	245.4	164.4
46	172.6	157.9	79	242.9	157.9
47	175.4	151.3	80	240.0	151.4
48	178.3	144.8	81	237.2	144.8
49	181.3	138.2	82	234.3	138.2
50	184.3	131.6	83	231.2	131.6
51	188.0	125.1	84	227.5	125.1
52	191.2	118.5	85	224.1	118.5
53	194.8	112.0	86	220.3	112.0

SHOT 4769 - Camera 2  
SHOCK FRONT POSITIONS

Exposure 1

Left			Right		
<i>n</i>	<i>x</i> (mm)	<i>y</i> (mm)	<i>n</i>	<i>x</i> (mm)	<i>y</i> (mm)
1	153.1	336.3	33	278.0	336.4
2	153.4	331.9	34	278.5	331.9
3	154.5	327.4	35	278.0	327.4
4	155.3	323.0	36	277.5	323.0
5	156.2	318.5	37	276.9	318.5
6	156.9	314.1	38	276.0	314.1
7	157.9	309.6	39	275.1	309.7
8	159.3	305.2	40	274.1	305.2
9	160.7	300.7	41	272.8	300.7
10	162.2	296.3	42	271.7	296.2
11	163.5	291.8	43	270.2	291.7
12	165.0	287.4	44	268.5	287.3
13	166.5	282.9	45	267.1	282.8
14	168.1	278.5	46	265.6	278.4
15	169.8	274.0	47	264.1	273.8
16	171.3	269.6	48	262.7	269.4
17	173.0	265.1	49	261.1	264.9
18	174.7	260.7	50	259.2	260.4
19	176.2	256.2	51	257.7	256.0
20	177.9	251.8	52	255.9	251.5

**AQUARIUM DATA**

21	179.5	247.3	53	253.9	247.0
22	181.7	242.8	54	252.2	242.5
23	183.5	238.4	55	250.3	238.1
24	185.4	233.9	56	248.3	233.6
25	187.5	229.5	57	246.3	229.2
26	189.5	225.1	58	244.3	224.7
27	191.6	220.6	59	242.2	220.3
28	194.1	216.2	60	239.9	215.8
29	196.5	211.7	61	237.3	211.4
30	198.9	207.3	62	234.7	206.8
31	201.8	202.8	63	232.4	202.4
32	204.1	198.3	64	229.8	197.9

**AQUARIUM DATA**

**Material:** PBX 9407    **Shot no.:** C-4809

**Experimenter:** T. E. Gould    **Date:** August 4, 1978

**Charge diameter:** 1.27 cm    **Charge length:** 22.9 cm

**Initial density:** 1.6 g/cm<sup>3</sup>    **Temperature:** 297 K

**Confinement:** Bare charge in water

**Booster:** One SE-1 detonator

**Exposures of image intensifier camera:** Two

**Time between exposures:** Camera 2, 10.02  $\mu$ s    **Detonation velocity:** 7.91 km/s

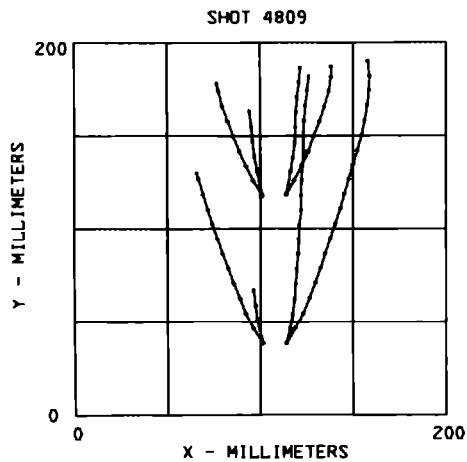

**SHOT 4809**  
**EXPLOSIVE (PIPE) - WATER INTERFACE POSITIONS**

**Exposure 1**

Left			Right		
<i>n</i>	<i>x</i> (mm)	<i>y</i> (mm)	<i>n</i>	<i>x</i> (mm)	<i>y</i> (mm)
1	101.2	117.8	7	113.9	118.2
2	98.4	130.8	8	116.3	130.4
3	97.1	138.8	9	117.8	138.4
4	96.1	146.8	10	118.5	146.4
5	95.3	154.7	11	118.9	154.4
6	94.4	162.7	12	119.4	162.4
			13	120.0	170.4
			14	121.0	178.3
			15	121.7	186.3

**Exposure 2**

Left			Right		
<i>n</i>	<i>x</i> (mm)	<i>y</i> (mm)	<i>n</i>	<i>x</i> (mm)	<i>y</i> (mm)
16	101.2	38.7	20	113.9	38.7
17	98.2	50.8	21	115.5	46.0
18	97.3	58.7	22	117.4	54.0
19	96.3	66.7	23	118.3	61.9
			24	119.0	69.9
			25	119.6	77.9
			26	120.2	85.9
			27	120.7	93.9
			28	121.1	101.8
			29	122.0	109.8
			30	122.0	117.8
			31	122.2	125.7
			32	122.8	133.7
			33	123.4	141.7
			34	123.2	149.7
			35	123.7	157.7
			36	124.3	165.6
			37	125.3	173.6
			38	126.3	181.6

## AQUARIUM DATA

## SHOCK FRONT POSITIONS

## Exposure 1

Left			Right		
<i>n</i>	<i>x</i> (mm)	<i>y</i> (mm)	<i>n</i>	<i>x</i> (mm)	<i>y</i> (mm)
39	101.2	117.8	48	113.9	118.2
40	96.3	125.8	49	118.4	125.9
41	92.4	133.8	50	122.3	133.8
42	89.0	141.8	51	125.9	141.8
43	85.6	149.7	52	128.8	149.8
44	82.5	157.7	53	132.0	157.7
45	79.8	165.7	54	134.5	165.7
46	77.6	173.7	55	137.0	173.7
47	76.6	177.7	56	138.2	181.6
			57	138.4	187.4

## Exposure 2

Left			Right		
<i>n</i>	<i>x</i> (mm)	<i>y</i> (mm)	<i>n</i>	<i>x</i> (mm)	<i>y</i> (mm)
58	101.2	38.7	71	113.9	38.7
59	96.1	46.8	72	118.7	46.7
60	92.1	54.7	73	122.9	54.7
61	88.9	62.6	74	126.3	62.7
62	85.6	70.6	75	129.3	70.7
63	82.6	78.6	76	132.3	78.6
64	79.8	86.5	77	135.0	86.6
65	77.0	94.5	78	137.8	94.6
66	74.4	102.5	79	140.3	102.6
67	71.8	110.4	80	143.0	110.6
68	69.4	118.4	81	145.3	118.6
69	67.0	126.4	82	147.8	126.6
70	65.9	129.7	83	150.0	134.5
			84	152.2	142.5
			85	154.5	150.5
			86	156.2	158.5
			87	157.8	166.5
			88	158.6	174.5
			89	159.0	182.4
			90	157.9	190.4

AQUARIUM DATA

**Material:** PBX 9407    **Shot no.:** C-4628

**Experimenter:** B. G. Craig    **Date:** August 27, 1976

**Charge diameter:** 1.25 cm    **Charge length:** 17.78 cm

**Initial density:** 1.610 g/cm<sup>3</sup>    **Temperature:** 296 K

**Confinement:** Bare charge in water

**Booster:** One SE-1 detonator

**Exposures of image intensifier camera:** One

**Detonation velocity:** 7.875 km/s

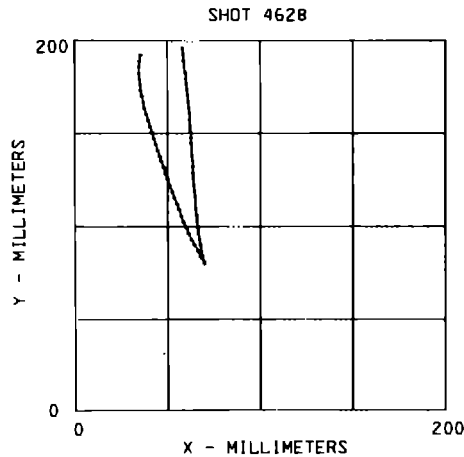

AQUARIUM DATA

SHOT 4628  
EXPLOSIVE (PIPE) - WATER INTERFACE POSITIONS

Exposure 1

<u>Left</u>		
<u>n</u>	<u>x (mm)</u>	<u>y (mm)</u>
1	58.3	195.6
2	58.6	192.3
3	58.8	189.1
4	59.1	185.9
5	59.6	182.7
6	59.9	179.5
7	60.4	176.3
8	60.7	173.1
9	61.0	169.9
10	61.4	166.7
11	61.6	163.5
12	62.0	160.2
13	62.1	157.0
14	62.2	153.8
15	62.4	150.6
16	62.6	147.4
17	62.8	144.2
18	62.9	141.0
19	63.3	137.8
20	63.5	134.6
21	63.7	131.4
22	63.8	128.1
23	64.1	124.9
24	64.4	121.7
25	64.7	118.5
26	64.9	115.3
27	65.1	112.1
28	65.3	108.9
29	65.7	105.6
30	66.0	102.5
31	66.4	99.3
32	66.7	96.0
33	67.2	92.8

AQUARIUM DATA

34	67.7	89.6
35	68.0	86.4
36	68.9	83.2
37	70.0	80.0

SHOCK FRONT POSITIONS

Exposure 1

<u>Left</u>		
<u>n</u>	<u>x (mm)</u>	<u>y (mm)</u>
38	35.7	192.3
39	35.0	189.1
40	34.6	185.9
41	34.8	182.7
42	35.1	179.5
43	35.3	176.3
44	35.8	173.1
45	36.3	169.9
46	37.0	166.7
47	37.8	163.5
48	38.7	160.2
49	39.5	157.0
50	40.6	153.8
51	41.7	150.6
52	42.8	147.4
53	43.7	144.2
54	44.7	141.0
55	45.9	137.8
56	46.8	134.6
57	47.9	131.4
58	49.1	128.1
59	50.2	124.9
60	51.3	121.7
61	52.6	118.5
62	53.7	115.3
63	54.9	112.1
64	56.2	108.9
65	57.4	105.7
66	58.8	102.5



## AQUARIUM DATA

67	60.2	99.3
68	61.6	96.0
69	63.1	92.8
70	64.6	89.6
71	66.5	86.4
72	68.1	83.2
73	70.0	80.0

AQUARIUM DATA

Material: PBX 9407 Shot no.: C-5023

Experimenter: S. Goldstein Date: June 23, 1980

Charge diameter: 1.25 cm Charge length: 31.8 cm

Initial density: 1.61 g/cm<sup>3</sup> Temperature: 302 K

Confinement: Bare charge in water

Booster: One SE-1 detonator and one PBX-9404 pellet

Exposures of image intensifier camera: Two

Time between exposures: 17.76  $\mu$ s Detonation velocity: 8.01 km/s

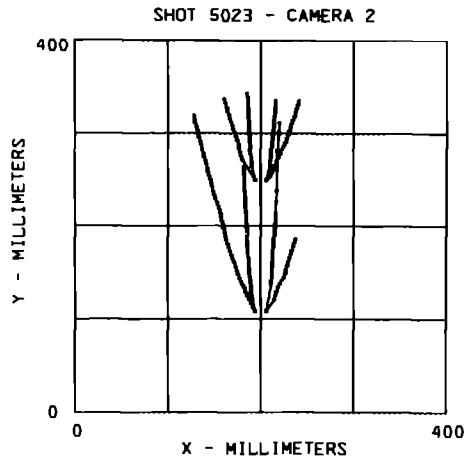
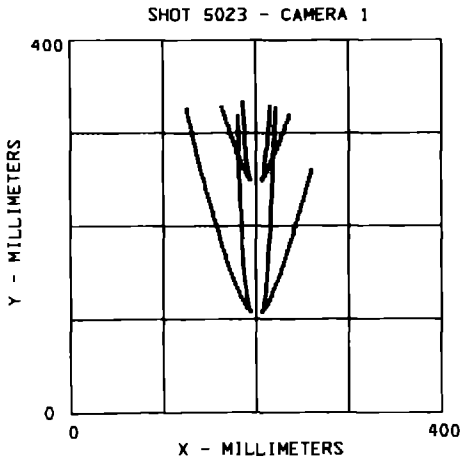

AQUARIUM DATA

SHOT 5023 - Camera 1  
EXPLOSIVE (PIPE) - WATER INTERFACE POSITIONS

Exposure 1

Left			Right		
<i>n</i>	<i>x</i> (mm)	<i>y</i> (mm)	<i>n</i>	<i>x</i> (mm)	<i>y</i> (mm)
1	186.0	332.6	22	215.4	328.4
2	186.3	328.4	23	215.1	324.3
3	186.6	324.3	24	214.9	320.2
4	186.8	320.2	25	214.6	316.1
5	187.0	316.1	26	214.2	311.9
6	187.2	311.9	27	213.9	307.8
7	187.5	307.8	28	213.6	303.7
8	187.7	303.7	29	213.3	299.5
9	187.8	299.5	30	212.8	295.4
10	187.9	295.4	31	212.4	291.3
11	188.1	291.3	32	211.9	287.2
12	188.3	287.2	33	211.5	283.0
13	188.6	283.0	34	210.9	278.9
14	189.0	278.9	35	210.4	274.8
15	189.3	274.8	36	210.0	270.7
16	189.9	270.7	37	209.5	266.5
17	190.5	266.5	38	209.1	262.4
18	191.6	262.4	39	209.4	258.3
19	192.3	258.3	40	206.4	250.0
20	192.6	254.1			
21	193.7	250.0			

Exposure 2

Left			Right		
<i>n</i>	<i>x</i> (mm)	<i>y</i> (mm)	<i>n</i>	<i>x</i> (mm)	<i>y</i> (mm)
41	180.5	318.3	93	221.4	326.7
42	180.7	314.1	94	221.0	322.6
43	180.7	310.0	95	220.8	318.5
44	180.8	305.9	96	220.6	314.3
45	180.9	301.7	97	220.5	310.2
46	180.9	297.6	98	220.3	306.0
47	181.1	293.5	99	220.1	301.9
48	181.2	289.4	100	219.9	297.8
49	181.4	285.2	101	219.7	293.6

AQUARIUM DATA

50	181.4	281.1	102	219.5	289.5
51	181.5	277.0	103	219.4	285.4
52	181.6	272.9	104	219.2	281.2
53	181.7	268.7	105	219.1	277.1
54	181.8	264.6	106	218.9	273.0
55	182.0	260.5	107	218.7	268.9
56	182.2	256.3	108	218.5	264.7
57	182.3	252.2	109	218.2	260.6
58	182.4	248.1	110	218.1	256.5
59	182.6	244.0	111	217.9	252.3
60	182.8	239.8	112	217.7	248.2
61	182.9	235.7	113	217.5	244.1
62	183.0	231.6	114	217.4	239.9
63	183.2	227.5	115	217.1	235.8
64	183.5	223.3	116	217.0	231.6
65	183.6	219.2	117	216.8	227.5
66	183.7	215.1	118	216.5	223.4
67	183.9	210.9	119	216.3	219.2
68	184.3	206.8	120	216.1	215.1
69	184.5	202.7	121	216.0	211.0
70	184.7	198.6	122	215.8	206.8
71	184.9	194.4	123	215.5	202.7
72	185.1	190.3	124	215.3	198.6
73	185.4	186.2	125	215.1	194.5
74	185.5	182.0	126	214.9	190.3
75	185.6	177.9	127	214.6	186.2
76	185.9	173.8	128	214.4	182.1
77	186.1	169.6	129	214.1	177.9
78	186.3	165.5	130	213.9	173.8
79	186.5	161.4	131	213.6	169.7
80	186.8	157.3	132	213.3	165.5
81	187.1	153.1	133	213.0	161.4
82	187.4	149.0	134	212.7	157.3
83	187.7	144.9	135	212.6	153.2
84	188.2	140.7	136	212.3	149.0
85	188.7	136.6	137	212.0	144.9
86	189.4	132.5	138	211.8	140.7
87	189.7	128.4	139	211.4	136.6
88	190.2	124.2	140	210.9	132.5
89	191.0	120.1	141	210.6	128.4
90	191.6	116.0	142	210.1	124.2

AQUARIUM DATA

91	192.2	111.8	143	209.6	120.1
92	193.7	107.7	144	208.8	116.0
			145	206.4	107.7

SHOCK FRONT POSITIONS

Exposure 1

Left			Right		
<i>n</i>	<i>x</i> (mm)	<i>y</i> (mm)	<i>n</i>	<i>x</i> (mm)	<i>y</i> (mm)
146	163.4	328.4	166	236.2	320.2
147	164.4	324.3	167	235.0	316.1
148	165.7	320.2	168	233.1	312.0
149	167.3	316.1	169	231.5	307.8
150	168.3	311.9	170	230.4	303.7
151	169.7	307.8	171	228.8	299.6
152	171.0	303.7	172	227.4	295.4
153	172.2	299.5	173	225.9	291.3
154	173.9	295.4	174	224.2	287.2
155	175.3	291.3	175	222.3	283.0
156	176.9	287.2	176	220.7	278.9
157	178.5	283.0	177	218.8	274.8
158	180.0	278.9	178	217.1	270.7
159	181.7	274.8	179	215.3	266.5
160	183.1	270.7	180	213.6	262.4
161	184.8	266.6	181	211.6	258.3
162	186.9	262.4	182	209.5	254.1
163	189.0	258.3	183	206.4	250.0
164	191.0	254.1			
165	193.7	250.0			

Exposure 2

Left			Right		
<i>n</i>	<i>x</i> (mm)	<i>y</i> (mm)	<i>n</i>	<i>x</i> (mm)	<i>y</i> (mm)
184	125.7	326.5	238	260.0	260.7
185	126.1	322.4	239	259.0	256.5
186	127.3	318.3	240	257.7	252.4
187	128.2	314.2	241	256.6	248.3
188	129.2	310.0	242	255.5	244.2
189	130.0	305.9	243	254.3	240.0

AQUARIUM DATA

190	130.7	301.8	244	253.0	235.9
191	131.6	297.6	245	252.0	231.8
192	132.4	293.5	246	250.6	227.6
193	133.6	289.4	247	249.4	223.5
194	134.4	285.2	248	248.1	219.3
195	135.4	281.1	249	247.0	215.2
196	136.6	277.0	250	245.6	211.1
197	137.7	272.9	251	244.4	206.9
198	138.7	268.8	252	242.9	202.8
199	139.8	264.6	253	241.8	198.7
200	140.7	260.5	254	240.8	194.5
201	141.8	256.3	255	239.7	190.4
202	143.2	252.2	256	238.4	186.2
203	144.6	248.1	257	237.3	182.1
204	145.5	244.0	258	236.0	178.0
205	146.2	239.8	259	234.6	173.8
206	147.4	235.7	260	233.1	169.7
207	148.5	231.6	261	231.8	165.5
208	149.8	227.5	262	230.5	161.4
209	150.8	223.3	263	229.2	157.3
210	152.0	219.2	264	227.6	153.1
211	153.1	215.1	265	226.5	149.0
212	154.2	210.9	266	224.9	144.9
213	155.4	206.8	267	223.1	140.7
214	156.7	202.7	268	221.5	136.6
215	158.1	198.5	269	219.7	132.5
216	159.1	194.4	270	218.1	128.4
217	160.5	190.3	271	216.6	124.2
218	162.0	186.1	272	214.6	120.1
219	163.1	182.0	273	212.4	115.9
220	164.0	177.9	274	210.3	111.8
221	165.3	173.8	275	206.4	107.7
222	167.0	169.6			
223	168.3	165.5			
224	169.6	161.4			
225	170.9	157.2			
226	172.1	153.1			
227	173.8	149.0			
228	175.3	144.9			
229	176.7	140.7			
230	178.2	136.6			

AQUARIUM DATA

231	179.9	132.5
232	181.7	128.4
233	183.6	124.2
234	185.7	120.1
235	187.7	116.0
236	190.1	111.8
237	193.7	107.7

SHOT 5023 - Camera 2  
EXPLOSIVE (PIPE) - WATER INTERFACE POSITIONS

Exposure 1

<u>Left</u>			<u>Right</u>		
<u>n</u>	<u>x (mm)</u>	<u>y (mm)</u>	<u>n</u>	<u>x (mm)</u>	<u>y (mm)</u>
1	185.6	342.6	22	215.9	334.6
2	185.8	338.5	23	215.7	330.6
3	186.0	334.4	24	215.4	326.5
4	186.3	330.3	25	215.1	322.4
5	186.5	326.3	26	214.7	318.4
6	186.6	322.2	27	214.3	314.3
7	186.7	318.2	28	214.0	310.2
8	187.0	314.1	29	213.7	306.2
9	187.2	310.0	30	213.4	302.1
10	187.3	306.0	31	212.9	298.0
11	187.5	301.2	32	212.5	294.0
12	187.8	297.8	33	212.1	289.9
13	187.9	293.8	34	211.8	285.8
14	188.1	289.7	35	211.5	281.8
15	188.6	285.6	36	211.2	277.7
16	188.9	281.6	37	210.8	273.6
17	189.2	277.5	38	210.2	269.6
18	189.7	273.4	39	210.0	265.5
19	190.3	269.4	40	206.3	250.0
20	190.8	265.3			
21	193.7	250.0			

## AQUARIUM DATA

## Exposure 2

Left			Right		
<i>n</i>	<i>x</i> (mm)	<i>y</i> (mm)	<i>n</i>	<i>x</i> (mm)	<i>y</i> (mm)
41	182.2	263.2	79	220.3	311.3
42	182.3	259.1	80	219.3	300.2
43	182.4	255.2	81	218.2	280.8
44	182.6	251.0	82	217.0	238.0
45	182.7	246.9	83	216.7	225.8
46	182.8	242.9	84	216.2	213.6
47	182.9	238.8	85	216.0	209.5
48	183.1	234.8	86	215.7	205.5
49	183.3	230.7	87	215.3	201.4
50	183.3	226.6	88	215.0	197.3
51	183.4	222.6	89	214.8	193.3
52	183.5	218.5	90	214.6	189.2
53	183.7	214.4	91	214.3	185.2
54	184.1	214.4	92	214.0	181.1
55	184.4	210.4	93	213.7	177.0
56	184.5	206.3	94	213.6	172.9
57	184.8	202.2	95	213.4	168.9
58	184.9	198.2	96	213.1	164.8
59	185.1	194.1	97	212.8	160.8
60	185.3	190.0	98	212.5	156.7
61	185.5	186.0	99	212.2	152.6
62	185.9	181.9	100	212.0	148.5
63	186.2	177.8	101	211.7	144.5
64	186.6	173.8	102	211.4	140.4
65	186.9	169.7	103	211.1	136.4
66	187.1	165.6	104	206.3	108.2
67	187.4	161.6			
68	187.6	157.5			
69	188.0	153.4			
70	188.3	149.4			
71	188.7	145.3			
72	189.2	141.3			
73	189.5	137.2			
74	189.9	133.1			
75	190.3	129.0			
76	190.8	125.0			
77	191.6	120.9			
78	193.7	108.2			



AQUARIUM DATA

SHOCK FRONT POSITIONS

Exposure 1

Left			Right		
<i>n</i>	<i>x</i> (mm)	<i>y</i> (mm)	<i>n</i>	<i>x</i> (mm)	<i>y</i> (mm)
105	160.6	337.1	123	241.3	335.4
106	161.8	333.1	124	239.7	331.3
107	163.1	329.0	125	238.7	327.3
108	164.3	325.0	126	237.4	323.2
109	165.8	320.9	127	236.4	319.1
110	166.8	316.8	128	234.8	315.1
111	167.9	312.8	129	233.4	311.0
112	169.1	308.7	130	232.0	306.9
113	170.2	304.6	131	230.5	302.9
114	171.7	300.6	132	229.3	298.8
115	173.0	296.5	133	227.9	294.7
116	174.4	292.4	134	226.4	290.7
117	175.7	288.4	135	224.6	286.6
118	176.8	284.3	136	222.9	282.5
119	177.9	280.2	137	221.2	278.5
120	179.2	276.2	138	219.3	274.4
121	180.9	272.1	139	217.5	270.3
122	193.7	250.0	140	215.7	266.3
			141	213.9	262.2
			142	211.9	258.1
			143	210.0	254.1
			144	206.3	250.0

Exposure 2

Left			Right		
<i>n</i>	<i>x</i> (mm)	<i>y</i> (mm)	<i>n</i>	<i>x</i> (mm)	<i>y</i> (mm)
145	127.8	319.7	198	237.7	186.1
146	128.6	315.6	199	236.4	182.0
147	129.6	311.5	200	235.1	178.0
148	130.9	307.4	201	233.7	173.9
149	131.8	303.4	202	232.5	169.8
150	132.6	299.3	203	231.3	165.8
151	133.6	295.3	204	229.7	161.7
152	134.8	291.2	205	228.6	157.6
153	136.0	287.1	206	227.6	153.6

AQUARIUM DATA

154	136.9	283.0	207	226.5	149.5
155	138.4	279.0	208	225.0	145.4
156	139.1	274.9	209	222.6	141.4
157	140.4	270.8	210	220.4	137.3
158	141.8	266.8	211	218.7	133.2
159	142.7	262.7	212	217.3	129.2
160	143.6	258.7	213	215.9	125.1
161	144.6	254.6	214	214.4	121.0
162	146.1	250.5	215	206.3	108.2
163	146.9	246.5			
164	147.8	242.4			
165	148.4	238.3			
166	149.8	234.3			
167	151.2	230.2			
168	152.6	226.1			
169	153.8	222.1			
170	155.1	218.0			
171	156.5	213.9			
172	157.4	209.9			
173	158.3	205.8			
174	159.1	201.7			
175	160.0	197.7			
176	161.3	193.6			
177	162.3	189.5			
178	163.5	185.5			
179	164.7	181.4			
180	166.1	177.3			
181	167.3	173.3			
182	168.7	169.2			
183	170.3	165.2			
184	171.7	161.1			
185	173.4	157.0			
186	174.9	152.9			
187	176.1	148.9			
188	177.0	144.8			
189	178.6	140.8			
190	180.5	136.8			
191	182.5	133.6			

#### AQUARIUM DATA

192	184.2	128.5
193	186.0	124.5
194	187.9	120.4
195	189.9	116.4
196	191.7	112.3
197	193.7	108.2

AQUARIUM DATA

Material: PBX 9501 Shot no.: C-4971

Experimenter: S. Goldstein Date: December 13, 1979

Charge diameter: 2.5 cm Charge length: 32.8 cm

Initial density: 1.84 g/cm<sup>3</sup> Temperature: 286 K

Confinement: Bare charge in water

Booster: One SE-1 detonator and one PBX-9407 pellet

Exposures of image intensifier camera: Two

Time between exposures: 12.95  $\mu$ s Detonation velocity: 8.85 km/s

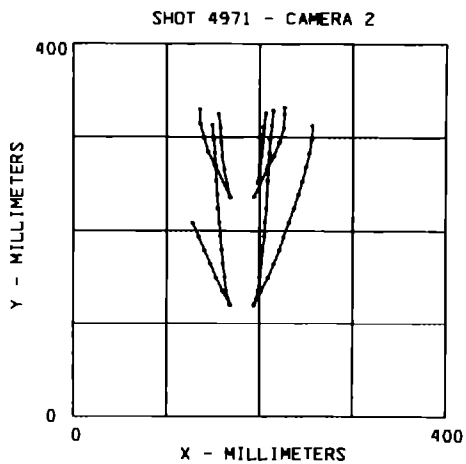
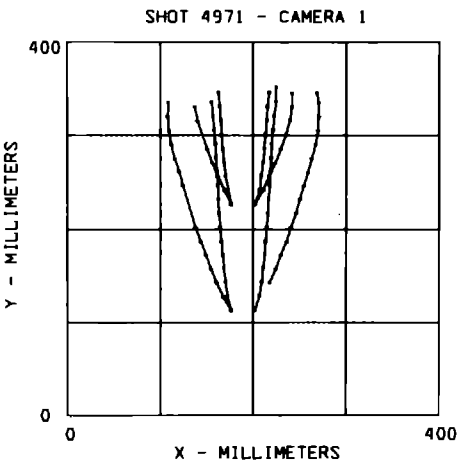

AQUARIUM DATA

SHOT 4971 - Camera 1  
EXPLOSIVE (PIPE) - WATER INTERFACE POSITIONS

Exposure 1

Left			Right		
<u>n</u>	<u>x (mm)</u>	<u>y (mm)</u>	<u>n</u>	<u>x (mm)</u>	<u>y (mm)</u>
1	162.5	344.8	10	217.1	345.0
2	163.7	330.0	11	215.3	330.2
3	165.2	315.1	12	214.4	315.4
4	166.1	300.3	13	213.2	300.6
5	167.4	285.5	14	212.2	285.8
6	168.7	270.7	15	210.7	271.0
7	170.5	255.9	16	208.6	256.2
8	173.0	241.1	17	207.0	241.4
9	176.8	226.3	18	202.3	226.5

Exposure 2

Left			Right		
<u>n</u>	<u>x (mm)</u>	<u>y (mm)</u>	<u>n</u>	<u>x (mm)</u>	<u>y (mm)</u>
19	155.1	335.0	35	224.9	349.8
20	156.8	320.1	36	224.7	335.1
21	158.1	305.3	37	222.4	320.2
22	159.2	290.5	38	221.0	305.4
23	160.2	275.7	39	219.9	290.6
24	161.0	260.9	40	219.1	275.8
25	162.0	246.1	41	218.5	261.0
26	162.8	231.3	42	217.7	246.2
27	163.6	216.5	43	216.6	231.4
28	164.8	201.7	44	215.7	216.6
29	166.2	186.9	45	214.7	201.8
30	167.1	172.0	46	213.4	187.0
31	168.5	157.3	47	212.4	172.1
32	170.7	142.4	48	210.7	157.3
33	172.5	127.6	49	209.1	142.5
34	176.8	112.8	50	206.7	127.7
			51	202.2	112.9

## SHOCK FRONT POSITIONS

## Exposure 1

Left			Right		
<i>n</i>	<i>x</i> (mm)	<i>y</i> (mm)	<i>n</i>	<i>x</i> (mm)	<i>y</i> (mm)
52	137.4	330.0	59	242.1	345.0
53	139.7	315.1	60	242.1	330.2
54	150.6	285.5	61	239.4	315.4
55	155.8	270.7	62	235.1	300.6
56	162.0	255.9	63	230.2	285.8
57	169.3	241.1	64	223.8	271.0
58	176.8	226.3	65	217.4	256.2
			66	210.6	241.4
			67	202.3	226.5

## Exposure 2

Left			Right		
<i>n</i>	<i>x</i> (mm)	<i>y</i> (mm)	<i>n</i>	<i>x</i> (mm)	<i>y</i> (mm)
68	108.7	335.0	82	268.4	344.6
69	108.3	320.1	83	270.6	335.0
70	109.4	305.3	84	270.9	320.2
71	112.2	290.5	85	269.7	305.4
72	115.5	275.7	86	267.0	290.6
73	120.4	260.9	87	263.4	275.8
74	124.9	246.1	88	259.4	261.0
75	138.2	201.7	89	254.9	246.2
76	143.9	186.9	90	250.2	231.4
77	149.4	172.0	91	245.8	216.6
78	154.7	157.2	92	240.7	201.7
79	160.7	142.4	93	235.9	186.9
80	168.3	127.6	94	230.2	172.1
81	176.8	112.8	95	224.5	157.3
			96	218.3	142.5

AQUARIUM DATA

SHOT 4971 - Camera 2  
 EXPLOSIVE (PIPE) - WATER INTERFACE POSITIONS

Exposure 1

Left			Right		
<i>n</i>	<i>x</i> (mm)	<i>y</i> (mm)	<i>n</i>	<i>x</i> (mm)	<i>y</i> (mm)
1	156.0	324.0	8	206.6	324.6
2	157.7	309.2	9	204.9	309.8
3	158.8	294.4	10	203.6	295.0
4	160.2	279.6	11	202.1	280.2
5	162.1	264.8	12	200.3	265.4
6	164.4	250.0	13	198.3	250.6
7	168.5	235.3			

Exposure 2

Left			Right		
<i>n</i>	<i>x</i> (mm)	<i>y</i> (mm)	<i>n</i>	<i>x</i> (mm)	<i>y</i> (mm)
14	149.2	312.1	28	214.5	327.1
15	150.5	297.4	29	213.2	312.3
16	151.8	282.6	30	211.5	297.5
17	152.4	267.8	31	210.4	282.7
18	153.5	253.0	32	209.6	267.9
19	154.4	238.2	33	208.9	253.0
20	155.4	223.3	34	208.1	238.2
21	156.8	208.5	35	207.2	223.4
22	157.9	193.7	36	206.2	208.6
23	159.4	178.9	37	205.0	193.8
24	160.8	164.1	38	203.5	179.0
25	162.8	149.4	39	202.3	164.2
26	164.3	134.5	40	200.3	149.4
27	168.6	119.7	41	198.6	134.6
			42	194.1	119.8

## SHOCK FRONT POSITIONS

## Exposure 1

Left			Right		
<i>n</i>	<i>x</i> (mm)	<i>y</i> (mm)	<i>n</i>	<i>x</i> (mm)	<i>y</i> (mm)
43	136.2	329.4	49	226.4	331.6
44	135.9	314.6	50	226.8	324.6
45	139.7	299.8	51	225.8	309.8
46	144.6	285.0	52	221.1	295.0
47	151.7	270.2	53	215.3	280.2
48	168.5	235.3	54	207.8	265.4

## Exposure 1

Left			Right		
<i>n</i>	<i>x</i> (mm)	<i>y</i> (mm)	<i>n</i>	<i>x</i> (mm)	<i>y</i> (mm)
56	128.3	208.6	63	256.7	312.2
57	134.9	193.8	64	256.2	297.5
58	140.7	179.0	65	253.4	282.6
59	147.4	164.2	66	249.8	267.8
60	153.6	149.4	67	245.9	253.0
61	160.6	134.5	68	241.1	238.2
62	168.6	119.7	69	236.5	223.4
			70	231.5	208.6
			71	226.2	193.8
			72	221.2	179.0
			73	215.6	164.2
			74	209.4	149.4
			75	201.6	134.6
			76	194.1	119.8



**AQUARIUM DATA**

**Material:** PBX 9501    **Shot no.:** C-4972

**Experimenter:** S. Goldstein    **Date:** December 14, 1979

**Charge diameter:** 2.5 cm    **Charge length:** 32.8 cm

**Initial density:** 1.84 g/cm<sup>3</sup>    **Temperature:** 280 K

**Confinement:** Bare charge in water

**Booster:** One SE-1 detonator and one PBX-9407 pellet

**Exposures of image intensifier camera:** Two

**Time between exposures:** 12.96 μs    **Detonation velocity:** 8.87 km/s

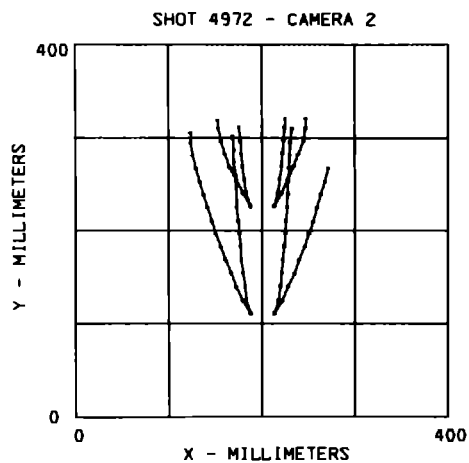
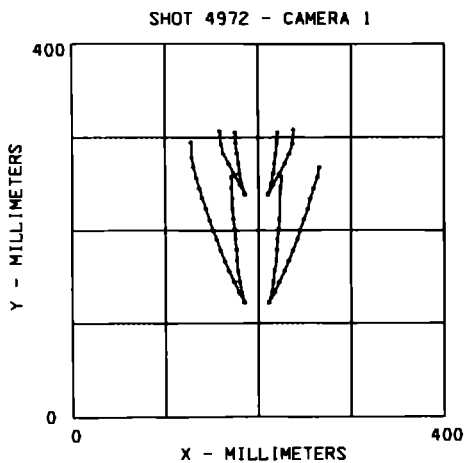

SHOT 4972 - Camera 1  
EXPLOSIVE (PIPE) - WATER INTERFACE POSITIONS

Exposure 1

Left			Right		
<i>n</i>	<i>x</i> (mm)	<i>y</i> (mm)	<i>n</i>	<i>x</i> (mm)	<i>y</i> (mm)
1	175.4	304.5	8	220.6	304.4
2	176.2	293.4	9	219.9	293.3
3	177.3	282.2	10	218.6	282.1
4	178.7	271.1	11	217.6	271.0
5	180.0	260.0	12	216.1	259.9
6	182.0	248.8	13	214.2	248.8
7	185.7	237.7	14	210.6	237.7

Exposure 2

Left			Right		
<i>n</i>	<i>x</i> (mm)	<i>y</i> (mm)	<i>n</i>	<i>x</i> (mm)	<i>y</i> (mm)
15	171.0	255.7	28	225.5	256.1
16	171.1	244.6	29	224.1	244.9
17	171.7	233.5	30	222.5	211.5
18	172.3	222.4	31	221.8	200.4
19	173.5	211.3	32	220.9	189.2
20	174.6	200.2	33	220.2	178.1
21	175.3	189.1	34	219.1	167.0
22	176.6	178.0	35	217.1	155.8
23	177.5	166.9	36	215.8	144.7
24	178.3	155.8	37	214.7	133.6
25	180.1	144.7	38	211.0	122.4
26	181.9	133.5			
27	185.6	122.4			

## AQUARIUM DATA

## SHOCK FRONT POSITIONS

## Exposure 1

Left			Right		
<i>n</i>	<i>x</i> (mm)	<i>y</i> (mm)	<i>n</i>	<i>x</i> (mm)	<i>y</i> (mm)
39	158.8	306.8	46	237.9	308.2
40	159.7	293.4	47	236.6	293.3
41	162.9	282.2	48	233.0	282.2
42	167.7	271.1	49	228.5	271.1
43	174.2	260.0	50	222.4	260.0
44	180.6	248.8	51	215.7	248.8
45	185.7	237.7	52	210.6	237.7

## Exposure 2

Left			Right		
<i>n</i>	<i>x</i> (mm)	<i>y</i> (mm)	<i>n</i>	<i>x</i> (mm)	<i>y</i> (mm)
53	127.9	294.6	69	265.8	267.3
54	128.6	278.2	70	263.0	256.2
55	130.6	267.1	71	260.0	245.1
56	133.2	255.9	72	256.3	234.0
57	136.4	244.8	73	253.1	222.8
58	140.1	233.7	74	249.0	211.7
59	143.9	222.6	75	245.6	200.6
60	147.2	211.5	76	241.9	189.5
61	151.0	200.3	77	237.5	178.3
62	155.3	189.2	78	232.9	166.9
63	159.5	178.1	79	228.1	155.8
64	164.0	166.9	80	222.8	144.7
65	168.7	155.8	81	217.0	133.5
66	174.0	144.7	82	211.0	122.4
67	179.1	133.5			
68	185.6	122.4			

SHOT 4972 - Camera 2  
EXPLOSIVE (PIPE) - WATER INTERFACE POSITIONS

Exposure 1

Left			Right		
<i>n</i>	<i>x</i> (mm)	<i>y</i> (mm)	<i>n</i>	<i>x</i> (mm)	<i>y</i> (mm)
1	175.8	310.4	8	225.5	319.1
2	177.0	296.3	9	224.4	310.9
3	178.3	282.2	10	223.3	296.8
4	179.6	268.1	11	222.3	282.7
5	181.5	254.0	12	221.2	268.6
6	183.5	239.8	13	219.4	254.5
7	187.8	225.7	14	217.2	240.3
			15	213.0	226.2

Exposure 2

Left			Right		
<i>n</i>	<i>x</i> (mm)	<i>y</i> (mm)	<i>n</i>	<i>x</i> (mm)	<i>y</i> (mm)
16	168.5	300.8	29	232.6	309.1
17	169.8	286.7	30	230.9	295.0
18	170.3	272.6	31	229.9	280.8
19	172.1	258.5	32	229.1	266.7
20	173.5	224.4	33	228.0	252.6
21	174.7	210.2	34	227.7	238.5
22	175.9	196.1	35	227.0	224.4
23	177.0	182.0	36	226.0	210.2
24	178.3	167.9	37	225.2	196.1
25	180.2	153.8	38	224.0	182.0
26	181.7	139.7	39	222.4	167.9
27	183.4	125.5	40	221.2	153.7
28	187.8	111.4	41	219.8	139.7
			42	218.1	125.5
			43	213.2	111.4

AQUARIUM DATA

SHOCK FRONT POSITIONS

Exposure 1

Left			Right		
<i>n</i>	<i>x</i> (mm)	<i>y</i> (mm)	<i>n</i>	<i>x</i> (mm)	<i>y</i> (mm)
44	152.5	318.9	52	247.5	320.4
45	153.6	310.4	53	247.5	310.9
46	156.5	296.3	54	244.7	296.8
47	160.8	282.2	55	239.6	282.7
48	165.3	268.1	56	233.9	268.6
49	172.5	254.0	57	228.3	254.5
50	179.7	239.8	58	221.2	240.3
51	187.8	225.7	59	213.0	226.2

Exposure 2

Left			Right		
<i>n</i>	<i>x</i> (mm)	<i>y</i> (mm)	<i>n</i>	<i>x</i> (mm)	<i>y</i> (mm)
60	123.9	305.5	75	271.5	266.7
61	123.8	294.9	76	267.9	252.6
62	125.9	280.8	77	263.3	238.5
63	129.2	266.6	78	259.2	224.4
64	133.1	252.6	79	255.2	210.2
65	137.4	238.5	80	250.4	196.1
66	141.7	224.4	81	245.9	182.0
67	146.4	210.2	82	240.2	167.9
68	150.8	196.1	83	235.0	153.7
69	155.7	182.0	84	228.2	139.7
70	161.1	167.9	85	221.7	125.5
71	167.3	153.7	86	213.2	111.4
72	172.9	139.6			
73	179.5	125.5			
74	187.8	111.4			

AQUARIUM DATA

Material: PBX 9501 Shot no.: C-5167

Experimenter: S. Goldstein Date: August 11, 1981

Charge diameter: 2.5 cm Charge length: 30.5 cm

Initial density: 1.84 g/cm<sup>3</sup> Temperature: 302 K

Confinement: Bare charge in alcohol

Booster: One SE-1 detonator and one PBX-9407 pellet

Exposures of image intensifier camera: Two

Time between exposures: 13.01  $\mu$ s Detonation velocity: 8.74 km/s

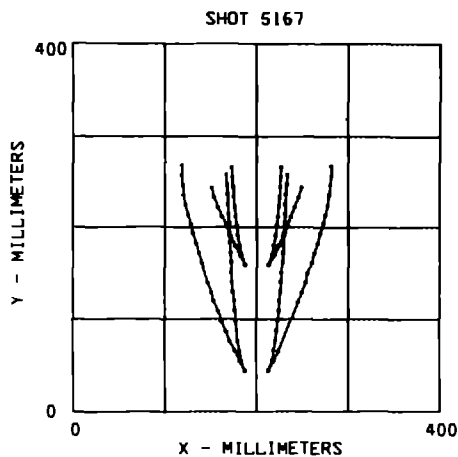

AQUARIUM DATA

SHOT 5167  
EXPLOSIVE (PIPE) - WATER INTERFACE POSITIONS

Exposure 1

Left			Right		
<i>n</i>	<i>x</i> (mm)	<i>y</i> (mm)	<i>n</i>	<i>x</i> (mm)	<i>y</i> (mm)
1	173.1	265.3	12	227.6	265.4
2	173.8	254.7	13	226.7	254.7
3	174.6	244.1	14	226.2	244.1
4	175.5	233.4	15	225.0	233.5
5	176.3	222.8	16	224.1	222.8
6	177.3	212.2	17	223.0	212.2
7	178.4	201.6	18	222.0	201.6
8	179.6	191.0	19	220.6	190.9
9	181.2	180.3	20	218.8	180.3
10	183.0	169.7	21	216.9	169.7
11	187.3	159.1	22	212.7	159.1

Exposure 2

Left			Right		
<i>n</i>	<i>x</i> (mm)	<i>y</i> (mm)	<i>n</i>	<i>x</i> (mm)	<i>y</i> (mm)
23	167.0	257.4	44	234.0	257.3
24	167.7	246.8	45	233.0	246.7
25	168.4	236.1	46	232.1	236.0
26	168.9	225.5	47	231.5	225.4
27	169.3	214.8	48	231.1	214.7
28	169.8	204.2	49	230.5	204.1
29	170.2	193.6	50	229.9	193.5
30	170.9	183.0	51	229.3	182.9
31	171.5	172.3	52	228.6	172.2
32	172.0	161.7	53	228.1	161.6
33	172.7	151.0	54	227.3	151.0
34	173.5	140.4	55	226.6	140.4
35	174.2	129.8	56	225.7	129.7
36	175.2	119.2	57	224.8	119.1
37	176.1	108.5	58	224.0	108.5
38	177.3	97.9	59	223.4	97.9
39	178.4	87.3	60	221.9	87.2

AQUARIUM DATA

40	179.5	76.6	61	220.5	76.6
41	181.1	66.0	62	218.8	65.9
42	183.3	55.4	63	217.2	55.3
43	187.3	44.7	64	212.7	44.7

SHOCK FRONT POSITIONS

Exposure 1

Left			Right		
<i>n</i>	<i>x</i> (mm)	<i>y</i> (mm)	<i>n</i>	<i>x</i> (mm)	<i>y</i> (mm)
65	151.1	244.1	74	249.4	244.1
66	154.1	233.4	75	246.2	233.4
67	158.0	222.8	76	241.6	222.8
68	162.5	212.2	77	237.6	212.2
69	167.1	201.5	78	233.3	201.6
70	171.4	190.9	79	229.0	190.9
71	176.4	180.3	80	224.1	180.3
72	181.9	169.7	81	219.4	169.7
73	187.3	159.1	82	212.7	159.1

Exposure 2

Left			Right		
<i>n</i>	<i>x</i> (mm)	<i>y</i> (mm)	<i>n</i>	<i>x</i> (mm)	<i>y</i> (mm)
83	119.1	268.0	104	281.9	267.6
84	118.7	257.4	105	281.8	257.0
85	119.9	246.8	106	280.8	246.4
86	120.6	236.1	107	279.4	235.8
87	122.5	225.5	108	277.7	225.2
88	125.4	214.8	109	275.2	214.5
89	128.1	204.2	110	272.4	203.9
90	130.8	193.6	111	269.5	193.3
91	133.7	183.0	112	266.4	182.7
92	137.4	172.3	113	262.9	172.1
93	139.9	161.7	114	260.0	161.5
94	146.8	140.4	115	256.2	150.9
95	150.7	129.8	116	253.2	140.3
96	153.6	119.2	117	249.3	129.6
97	158.0	108.5	118	245.5	119.0
98	162.2	98.0	119	223.7	65.9



**AQUARIUM DATA**

99	166.6	87.2	120	218.9	55.3
100	170.9	76.6	121	212.7	44.7
101	176.8	66.0			
102	182.0	55.4			
103	187.3	44.7			

AQUARIUM DATA

Material: PBX 9501 Shot no.: C-5168

Experimenter: S. Goldstein Date: August 14, 1981

Charge diameter: 2.5 cm Charge length: 32.5 cm

Initial density: 1.84 g/cm<sup>3</sup> Temperature: 218 K

Confinement: Bare charge in cold alcohol

Booster: One RP-1/PT detonator and one PBX-9407 pellet

Exposures of image intensifier camera: Two

Time between exposures: 13.01  $\mu$ s Detonation velocity: 9.01 km/s

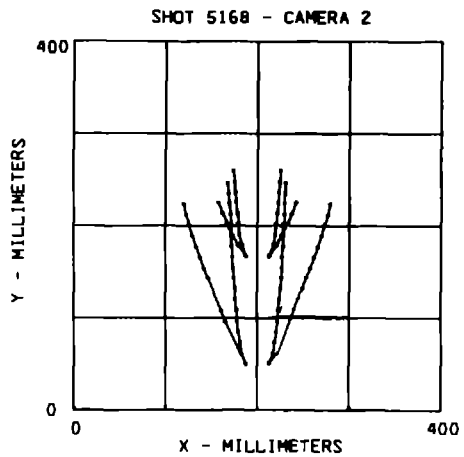
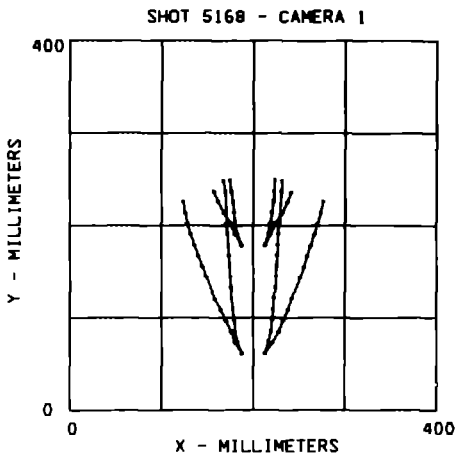

## AQUARIUM DATA

SHOT 5168 - Camera 1  
EXPLOSIVE (PIPE) - WATER INTERFACE POSITIONS

## Exposure 1

Left			Right		
<i>n</i>	<i>x</i> (mm)	<i>y</i> (mm)	<i>n</i>	<i>x</i> (mm)	<i>y</i> (mm)
1	174.9	249.2	8	223.5	249.2
2	176.2	237.5	9	222.6	237.5
3	177.6	225.8	10	221.8	225.8
4	178.5	214.1	11	220.3	214.1
5	179.9	202.4	12	218.9	202.4
6	182.8	190.7	13	216.9	190.7
7	187.3	179.0	14	212.7	179.0

## Exposure 2

Left			Right		
<i>n</i>	<i>x</i> (mm)	<i>y</i> (mm)	<i>n</i>	<i>x</i> (mm)	<i>y</i> (mm)
15	167.2	249.0	30	231.1	249.0
16	169.0	237.3	31	230.9	237.3
17	170.9	202.3	32	227.9	202.3
18	171.9	190.6	33	227.6	190.6
19	172.6	178.9	34	226.9	178.9
20	173.4	167.2	35	226.3	167.2
21	174.2	155.5	36	225.5	155.5
22	174.8	143.9	37	224.8	143.9
23	175.6	132.2	38	223.9	132.2
24	176.5	120.5	39	222.9	120.5
25	177.9	108.8	40	221.9	108.8
26	179.1	97.1	41	220.6	97.1
27	180.1	85.4	42	219.1	85.3
28	182.6	73.7	43	216.3	73.7
29	187.3	62.1	44	212.7	62.1

## SHOCK FRONT POSITIONS

## Exposure 1

Left			Right		
<i>n</i>	<i>x</i> (mm)	<i>y</i> (mm)	<i>n</i>	<i>x</i> (mm)	<i>y</i> (mm)
45	156.6	238.0	51	241.6	237.5
46	161.6	225.8	52	237.0	225.8
47	167.5	214.1	53	231.0	214.1
48	174.8	202.4	54	224.9	202.4
49	180.5	190.7	55	218.9	190.7
50	187.3	179.0	56	212.7	179.0

## Exposure 2

Left			Right		
<i>n</i>	<i>x</i> (mm)	<i>y</i> (mm)	<i>n</i>	<i>x</i> (mm)	<i>y</i> (mm)
57	123.0	225.7	71	276.1	225.7
58	125.5	214.0	72	273.6	214.0
59	128.0	202.3	73	269.8	202.3
60	131.8	190.6	74	266.4	190.6
61	136.1	178.9	75	262.7	178.9
62	140.0	167.2	76	258.8	167.2
63	144.9	155.6	77	255.2	155.5
64	148.8	143.9	78	251.6	143.9
65	158.2	120.5	79	242.3	120.5
66	164.9	108.8	80	238.0	108.8
67	170.2	97.1	81	232.8	97.1
68	175.9	85.4	82	228.2	85.4
69	180.2	73.7	83	221.4	73.7
70	187.3	62.1	84	212.7	62.1

AQUARIUM DATA

SHOT 5168 - Camera 2  
EXPLOSIVE (PIPE) - WATER INTERFACE POSITIONS

Exposure 1

Left			Right		
<i>n</i>	<i>x</i> (mm)	<i>y</i> (mm)	<i>n</i>	<i>x</i> (mm)	<i>y</i> (mm)
1	174.1	259.8	10	225.4	259.7
2	175.0	248.2	11	224.6	248.1
3	175.9	236.6	12	223.6	236.5
4	176.6	225.1	13	222.5	225.0
5	177.7	213.4	14	221.6	213.4
6	179.0	201.9	15	220.4	201.8
7	180.5	190.3	16	219.0	190.2
8	183.2	178.7	17	217.1	178.7
9	187.3	167.1	18	212.7	167.1

Exposure 2

Left			Right		
<i>n</i>	<i>x</i> (mm)	<i>y</i> (mm)	<i>n</i>	<i>x</i> (mm)	<i>y</i> (mm)
19	167.5	247.0	37	230.9	247.0
20	168.8	235.4	38	230.0	235.4
21	169.4	223.8	39	229.6	223.8
22	170.4	212.3	40	229.1	212.2
23	171.0	200.6	41	228.8	200.6
24	171.5	189.1	42	228.1	189.0
25	172.2	177.4	43	227.7	177.4
26	172.9	165.9	44	226.9	165.8
27	173.6	154.3	45	226.4	154.2
28	174.3	142.7	46	225.7	142.6
29	175.3	131.1	47	224.8	131.0
30	176.2	119.5	48	224.0	119.5
31	177.3	107.9	49	222.9	107.9
32	178.1	96.3	50	221.9	96.3
33	179.6	84.7	51	220.5	84.7
34	181.3	73.1	52	218.7	73.1
35	182.8	61.5	53	216.7	61.5
36	187.3	49.9	54	212.7	49.9

## SHOCK FRONT POSITIONS

## Exposure 1

Left			Right		
<i>n</i>	<i>x</i> (mm)	<i>y</i> (mm)	<i>n</i>	<i>x</i> (mm)	<i>y</i> (mm)
55	157.5	225.1	61	241.8	225.1
56	162.1	213.5	62	237.0	213.5
57	167.5	201.9	63	232.4	201.9
58	172.7	190.3	64	226.9	190.3
59	179.1	178.7	65	220.9	178.7
60	187.3	167.1	66	212.7	167.1

## Exposure 2

Left			Right		
<i>n</i>	<i>x</i> (mm)	<i>y</i> (mm)	<i>n</i>	<i>x</i> (mm)	<i>y</i> (mm)
67	119.0	223.9	78	279.4	223.8
68	122.3	212.3	79	276.9	212.3
69	126.1	200.7	80	273.2	200.7
70	129.2	189.1	81	270.1	189.1
71	133.0	177.5	82	265.9	177.5
72	137.3	165.9	83	261.8	165.9
73	141.4	154.3	84	257.5	154.3
74	146.0	142.7	85	252.6	142.7
75	160.5	107.9	86	248.7	131.1
76	165.6	96.3	87	244.1	121.0
77	187.3	49.9	88	240.3	109.4
			89	222.5	63.0
			90	212.7	51.5

**AQUARIUM DATA**

**Material:** PBX 9502    **Shot no.:** C-5149

**Experimenter:** S. Goldstein    **Date:** May 28, 1981

**Charge diameter:** 2.5 cm    **Charge length:** 30.5 cm

**Initial density:** 1.891 g/cm<sup>3</sup>    **Temperature:** 287 K

**Confinement:** Bare charge in alcohol

**Booster:** One RP-1/PT detonator and one PBX-9407 pellet

**Exposures of image intensifier camera:** Two

**Time between exposures:** Camera 1, 16.96  $\mu$ s; Camera 2, 16.83  $\mu$ s

**Detonation velocity:** 7.74 km/s

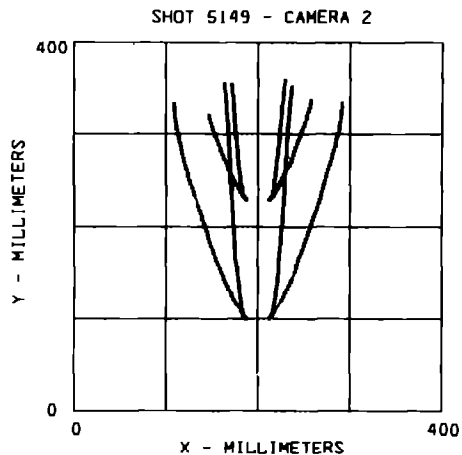
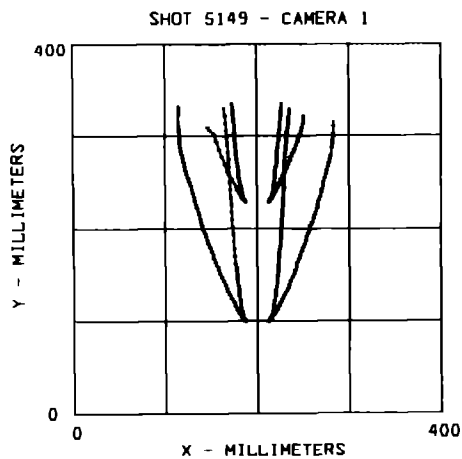

SHOT 5149 - Camera 1  
EXPLOSIVE (PIPE) - WATER INTERFACE POSITIONS

## Exposure 1

Left			Right		
<i>n</i>	<i>x</i> (mm)	<i>y</i> (mm)	<i>n</i>	<i>x</i> (mm)	<i>y</i> (mm)
1	172.6	334.7	29	226.5	334.6
2	173.1	330.7	30	226.6	330.6
3	173.7	326.8	31	226.0	326.6
4	174.2	322.8	32	225.8	322.6
5	174.5	318.8	33	225.3	318.7
6	174.5	314.8	34	224.9	314.7
7	175.1	310.8	35	224.8	310.7
8	175.3	306.8	36	224.5	306.7
9	175.5	302.9	37	224.1	302.7
10	176.0	298.9	38	223.7	298.7
11	176.3	294.9	39	223.4	294.8
12	176.5	290.9	40	222.7	290.8
13	176.8	286.9	41	222.6	286.8
14	177.2	282.9	42	222.2	282.8
15	177.6	279.0	43	221.8	278.8
16	178.0	275.0	44	221.4	274.9
17	178.6	271.0	45	221.1	270.9
18	179.1	267.0	46	220.7	267.0
19	179.7	263.0	47	220.2	262.9
20	180.2	259.0	48	219.6	258.9
21	180.8	255.0	49	219.1	254.9
22	181.4	251.0	50	218.7	251.0
23	181.9	247.0	51	218.0	247.0
24	182.4	243.1	52	217.2	243.0
25	183.0	239.1	53	216.6	239.0
26	183.9	235.1	54	215.7	235.0
27	185.2	232.5	55	214.3	232.4
28	187.3	230.2	56	212.7	230.2



## AQUARIUM DATA

## Exposure 2

Left			Right		
<i>n</i>	<i>x</i> (mm)	<i>y</i> (mm)	<i>n</i>	<i>x</i> (mm)	<i>y</i> (mm)
57	164.2	329.8	95	235.6	328.5
58	165.2	321.8	96	235.0	324.5
59	165.9	313.8	97	234.5	320.5
60	166.6	305.7	98	234.0	316.5
61	167.6	297.8	99	233.8	312.5
62	168.3	289.7	100	233.4	308.6
63	168.7	281.7	101	232.9	304.6
64	169.1	273.7	102	232.6	300.6
65	169.6	265.7	103	232.3	296.6
66	170.0	257.7	104	232.0	292.7
67	170.4	249.7	105	231.4	288.6
68	170.7	241.7	106	231.1	284.7
69	171.4	233.6	107	230.9	280.7
70	171.8	225.7	108	230.8	276.7
71	172.3	217.7	109	230.6	272.7
72	172.8	209.6	110	230.4	268.8
73	173.3	201.6	111	230.1	264.8
74	173.8	193.7	112	230.0	260.8
75	174.8	185.7	113	229.6	256.8
76	175.4	177.7	114	229.6	252.8
77	176.1	169.7	115	229.4	248.9
78	176.6	161.7	116	229.3	244.9
79	177.0	157.7	117	228.8	240.9
80	177.3	153.7	118	228.4	236.9
81	177.8	149.8	119	228.3	232.9
82	178.2	145.8	120	228.0	228.9
83	178.7	141.8	121	227.8	225.0
84	179.1	137.8	122	227.6	221.0
85	179.7	133.8	123	227.4	217.0
86	180.2	129.9	124	227.3	213.0
87	180.6	125.9	125	226.8	209.1
88	181.2	121.9	126	226.6	205.1
89	181.7	117.9	127	226.5	201.1
90	182.3	113.9	128	226.3	197.1
91	183.1	109.9	129	226.0	193.2
92	184.0	105.9	130	225.7	189.2

AQUARIUM DATA

93	185.5	101.9	131	225.4	185.2
94	187.3	100.0	132	225.1	181.2
			133	224.7	177.2
			134	224.2	173.2
			135	223.8	169.3
			136	223.5	165.3
			137	223.2	161.3
			138	222.9	157.3
			139	222.4	153.3
			140	222.0	149.4
			141	221.6	145.4
			142	221.1	141.4
			143	220.7	137.4
			144	220.3	133.4
			145	219.7	129.5
			146	219.2	125.8
			147	218.7	121.5
			148	218.1	117.5
			149	217.3	113.6
			150	216.9	109.6
			151	215.9	105.6
			152	214.6	102.9
			153	212.7	100.0

SHOCK FRONT POSITIONS

Exposure 1

Left			Right		
<i>n</i>	<i>x</i> (mm)	<i>y</i> (mm)	<i>n</i>	<i>x</i> (mm)	<i>y</i> (mm)
154	146.6	309.9	168	250.8	322.0
155	149.3	305.9	169	250.6	318.1
156	153.2	302.0	170	250.2	314.0
157	156.3	294.0	171	249.1	310.1
158	158.6	286.0	172	248.3	306.0
159	161.9	278.0	173	247.2	302.1
160	165.6	270.1	174	245.6	298.1
161	168.5	262.1	175	244.2	294.1
162	172.9	254.2	176	242.6	290.1
163	177.2	246.2	177	241.1	286.2
164	178.9	242.2	178	239.2	282.2

AQUARIUM DATA

165	181.1	238.2	179	237.5	278.2
166	183.1	234.2	180	235.9	274.2
167	187.3	230.2	181	234.2	270.2
			182	232.6	266.2
			183	230.9	262.2
			184	228.8	258.2
			185	226.7	254.2
			186	224.8	250.2
			187	222.0	246.2
			188	219.9	242.2
			189	218.1	238.2
			190	215.7	234.2
			191	212.7	230.2

Exposure 2

Left			Right		
<i>n</i>	<i>x</i> (mm)	<i>y</i> (mm)	<i>n</i>	<i>x</i> (mm)	<i>y</i> (mm)
192	114.5	331.7	250	283.5	315.4
193	114.6	327.7	251	283.3	311.5
194	114.9	323.7	252	283.1	303.5
195	114.7	315.7	253	283.0	299.5
196	114.9	311.7	254	282.5	295.6
197	115.1	307.7	255	281.9	291.5
198	115.9	303.7	256	281.2	287.5
199	116.2	299.7	257	280.4	279.5
200	116.3	295.7	258	279.5	275.5
201	116.1	291.7	259	278.5	271.6
202	116.8	287.7	260	277.3	267.5
203	117.6	283.7	261	276.3	263.6
204	118.6	279.7	262	275.2	259.6
205	119.9	275.7	263	274.0	255.5
206	120.9	271.7	264	272.9	251.5
207	121.9	267.6	265	271.7	247.5
208	122.9	263.6	266	270.7	243.6
209	123.9	259.6	267	269.5	239.6
210	125.1	255.6	268	268.4	235.6
211	126.5	251.6	269	266.9	231.6
212	127.7	247.6	270	266.0	227.6
213	128.9	243.6	271	265.4	223.6
214	130.1	239.6	272	263.7	219.6

AQUARIUM DATA

215	131.1	235.6	273	262.6	215.6
216	132.3	231.6	274	261.2	211.6
217	133.4	227.6	275	259.7	207.6
218	134.4	223.6	276	258.3	203.7
219	135.7	219.6	277	257.2	199.7
220	137.1	215.6	278	255.8	195.7
221	138.1	211.6	279	254.3	191.7
222	139.0	207.6	280	253.2	187.7
223	139.8	203.7	281	251.7	183.7
224	141.4	199.6	282	250.3	179.7
225	143.3	195.6	283	248.9	175.7
226	144.7	191.7	284	247.5	171.8
227	145.8	187.7	285	245.8	167.8
228	147.6	183.7	286	244.2	163.8
229	149.3	179.7	287	242.5	159.8
230	150.7	175.7	288	241.2	155.8
231	152.4	171.8	289	239.8	151.8
232	153.4	167.8	290	238.2	147.8
233	155.1	163.8	291	236.3	143.9
234	156.6	159.8	292	234.6	139.9
235	158.0	155.8	293	233.0	135.9
236	159.4	151.8	294	231.2	131.9
237	161.6	147.9	295	229.4	127.9
238	163.0	143.9	296	227.3	123.9
239	165.0	139.9	297	225.3	119.9
240	166.6	136.0	298	223.3	116.0
241	168.1	131.9	299	221.4	112.0
242	170.2	128.0	300	218.4	108.0
243	172.1	124.0	301	215.5	104.0
244	174.4	120.0	302	212.7	100.0
245	175.8	116.0			
246	178.0	112.0			
247	180.4	108.0			
248	183.5	104.0			
249	187.3	100.0			

AQUARIUM DATA

SHOT 5149 - Camera 2  
 EXPLOSIVE (PIPE) - WATER INTERFACE POSITIONS

Exposure 1

Left			Right		
<i>n</i>	<i>x</i> (mm)	<i>y</i> (mm)	<i>n</i>	<i>x</i> (mm)	<i>y</i> (mm)
1	171.3	353.2	34	229.3	357.8
2	171.9	349.2	35	228.7	353.8
3	172.3	345.2	36	228.3	349.9
4	172.7	341.3	37	227.9	345.9
5	173.1	337.3	38	227.4	341.9
6	173.4	333.3	39	227.1	338.0
7	173.8	329.4	40	226.7	334.0
8	174.1	325.4	41	226.3	330.0
9	174.4	321.5	42	225.9	326.1
10	174.6	317.5	43	225.6	322.1
11	174.9	313.5	44	225.4	318.1
12	175.2	309.5	45	224.9	314.2
13	175.5	305.6	46	224.6	310.2
14	175.8	301.6	47	224.3	306.2
15	176.3	297.7	48	224.0	302.3
16	176.7	293.7	49	223.6	298.3
17	177.0	289.7	50	223.3	294.3
18	177.4	285.7	51	223.0	290.4
19	177.8	281.8	52	222.6	286.3
20	178.1	277.8	53	222.3	282.4
21	178.7	273.9	54	221.9	278.5
22	179.0	269.9	55	221.4	274.5
23	179.6	265.9	56	220.9	270.5
24	180.1	262.0	57	220.5	266.6
25	180.6	258.0	58	220.0	262.6
26	181.1	254.0	59	219.5	258.6
27	181.4	250.0	60	219.0	254.7
28	181.9	246.1	61	218.5	250.7
29	182.9	242.1	62	217.7	246.7
30	183.5	238.2	63	217.1	242.8
31	184.1	234.2	64	216.5	238.8
32	185.3	232.0	65	216.1	234.8
33	187.3	230.1	66	214.9	232.3
			67	212.7	230.1

## Exposure 2

Left			Right		
<i>n</i>	<i>x</i> (mm)	<i>y</i> (mm)	<i>n</i>	<i>x</i> (mm)	<i>y</i> (mm)
68	163.4	354.5	134	236.9	351.0
69	163.6	350.6	135	236.1	347.0
70	164.3	346.6	136	235.8	343.1
71	164.5	342.6	137	235.3	339.1
72	164.9	338.7	138	234.9	335.1
73	165.3	334.7	139	234.6	331.2
74	165.8	330.8	140	234.2	327.2
75	166.2	326.8	141	233.8	323.3
76	166.2	322.8	142	233.4	319.3
77	166.8	318.8	143	233.1	315.3
78	166.9	314.9	144	232.8	311.3
79	167.2	310.9	145	232.6	307.4
80	167.6	307.0	146	232.3	303.4
81	167.6	303.0	147	232.0	299.4
82	168.1	299.0	148	231.7	295.5
83	168.4	295.1	149	231.6	291.5
84	168.7	291.1	150	231.5	287.5
85	168.9	287.1	151	231.4	283.6
86	169.1	283.1	152	231.3	279.6
87	169.3	279.2	153	231.1	275.6
88	169.6	275.2	154	230.8	271.7
89	169.7	271.3	155	230.5	267.7
90	170.1	267.3	156	230.1	263.7
91	170.0	263.3	157	229.8	259.8
92	170.1	259.4	158	229.5	255.8
93	170.2	255.4	159	229.3	251.9
94	170.6	251.4	160	229.1	247.9
95	170.8	247.5	161	228.9	243.9
96	171.1	243.5	162	228.7	239.9
97	171.3	239.5	163	228.4	236.0
98	171.4	235.5	164	228.2	232.0
99	171.6	231.6	165	228.1	228.1
100	171.8	227.6	166	227.9	224.1
101	172.1	223.7	167	227.6	220.1
102	172.3	219.7	168	227.4	216.1
103	172.7	215.7	169	227.1	212.2
104	173.0	211.7	170	226.9	208.2

AQUARIUM DATA

105	173.3	207.8	171	226.5	204.2
106	173.6	203.8	172	226.1	200.3
107	173.8	199.9	173	225.8	196.3
108	174.1	195.9	174	225.5	192.4
109	174.3	191.9	175	225.3	188.4
110	174.5	187.9	176	225.0	184.4
111	174.9	184.0	177	224.6	180.4
112	175.4	180.0	178	224.3	176.5
113	175.5	176.1	179	223.9	172.5
114	175.7	172.1	180	223.6	168.6
115	176.1	168.1	181	223.3	164.6
116	176.3	164.1	182	222.9	160.6
117	176.7	160.2	183	222.6	156.7
118	177.1	156.2	184	222.2	152.7
119	177.5	152.2	185	221.9	148.7
120	177.8	148.3	186	221.4	144.8
121	178.4	144.3	187	221.0	140.8
122	178.8	140.4	188	220.7	136.8
123	179.2	136.4	189	220.1	132.8
124	179.7	132.4	190	219.5	128.9
125	180.1	128.4	191	219.0	124.9
126	180.6	124.5	192	218.5	121.0
127	181.1	120.5	193	218.0	117.0
128	181.7	116.6	194	217.3	113.0
129	182.1	112.6	195	216.7	109.0
130	183.1	108.6	196	215.8	105.1
131	184.2	104.6	197	214.7	102.6
132	185.6	102.1	198	212.7	100.0
133	187.3	100.0			

SHOCK FRONT POSITIONS

Exposure 1

Left			Right		
<i>n</i>	<i>x</i> (mm)	<i>y</i> (mm)	<i>n</i>	<i>x</i> (mm)	<i>y</i> (mm)
199	146.4	321.4	223	257.6	337.3
200	147.3	317.4	224	256.6	333.3
201	148.6	313.4	225	255.7	329.3
202	149.8	309.4	226	254.5	325.4
203	151.1	305.5	227	253.5	321.4

AQUARIUM DATA

204	152.7	301.5	228	252.5	317.4
205	154.1	297.6	229	251.2	313.5
206	155.9	293.6	230	249.8	309.5
207	157.3	289.6	231	248.3	305.6
208	159.0	285.6	232	247.2	301.6
209	160.3	281.7	233	245.8	297.6
210	162.0	277.7	234	244.0	293.6
211	163.6	273.8	235	242.5	289.7
212	165.8	269.8	236	241.2	285.7
213	167.0	265.8	237	239.9	281.7
214	168.6	261.9	238	238.6	277.8
215	170.7	257.9	239	237.2	273.8
216	172.9	253.9	240	235.8	269.8
217	174.7	250.0	241	233.7	265.8
218	176.7	246.0	242	229.3	257.9
219	179.1	242.0	243	227.2	253.9
220	181.1	238.1	244	225.4	250.0
221	183.8	234.1	245	223.5	246.0
222	187.3	230.1	246	221.1	242.0
			247	218.9	238.1
			248	216.5	234.1
			249	212.7	230.1

Exposure 2

Left			Right		
<u>n</u>	<u>x (mm)</u>	<u>y (mm)</u>	<u>n</u>	<u>x (mm)</u>	<u>y (mm)</u>
250	108.8	334.1	307	291.4	334.0
251	109.1	330.1	308	291.3	330.1
252	109.3	326.1	309	290.6	326.1
253	109.9	322.1	310	290.1	322.1
254	110.3	318.2	311	289.7	318.1
255	110.9	314.2	312	289.0	314.2
256	111.6	310.2	313	288.4	310.2
257	112.2	306.3	314	287.9	306.3
258	113.0	302.3	315	287.5	302.3
259	113.8	298.3	316	286.4	298.3
260	114.7	294.4	317	285.5	294.4
261	115.6	290.4	318	284.6	290.4
262	116.6	286.4	319	283.8	286.4
263	117.6	282.5	320	282.7	282.5
264	118.3	278.5	321	281.6	278.5



AQUARIUM DATA

265	119.3	274.5	322	280.4	274.5
266	120.3	270.6	323	279.2	270.6
267	121.4	266.6	324	278.2	266.6
268	122.5	276.6	325	276.9	262.6
269	123.7	258.7	326	275.6	258.6
270	124.8	254.7	327	274.3	254.7
271	126.0	250.7	328	273.3	250.7
272	127.5	246.8	329	272.2	246.8
273	128.8	242.8	330	270.8	242.8
274	130.3	238.8	331	269.6	238.8
275	131.5	234.9	332	268.6	234.9
276	135.3	223.0	333	267.3	230.9
277	136.7	219.0	334	266.0	226.9
278	137.9	215.0	335	264.7	223.0
279	139.0	211.1	336	263.5	219.0
280	140.3	207.1	337	262.0	215.0
281	141.8	203.1	338	260.6	211.1
282	142.7	199.2	339	259.3	207.1
283	144.5	195.2	340	258.0	203.1
284	145.9	191.2	341	256.5	199.2
285	146.9	187.3	342	255.2	195.2
286	148.2	183.3	343	253.8	191.2
287	149.5	179.3	344	252.5	187.3
288	151.1	175.3	345	251.3	183.3
289	152.5	171.4	346	250.0	179.3
290	153.9	167.4	347	248.5	175.4
291	155.6	163.4	348	247.0	171.4
292	157.0	159.5	349	245.5	167.5
293	158.4	155.5	350	244.2	163.5
294	159.9	151.5	351	242.7	159.5
295	161.8	147.6	352	241.3	155.5
296	163.6	143.6	353	239.7	151.6
297	164.7	139.7	354	236.4	143.6
298	166.5	135.7	355	235.0	139.7
299	168.0	131.7	356	233.0	135.7
300	170.4	127.7	357	231.4	131.7
301	172.1	123.8	358	229.6	127.8
302	174.2	119.8	359	227.8	123.8
303	176.5	115.9	360	225.7	119.9
304	181.9	107.9	361	218.0	108.0
305	184.0	103.9	362	215.8	104.0
306	187.3	100.0	363	212.7	100.0

AQUARIUM DATA

Material: PBX 9502 Shot no.: C-4976

Experimenter: S. Goldstein Date: January 22, 1980

Charge diameter: 1.8 cm Charge length: 30.5 cm

Initial density: 1.893 g/cm<sup>3</sup> Temperature: 289 K

Confinement: Bare charge in water

Booster: One SE-1 detonator

Exposures of image intensifier camera: Two

Time between exposures: 16.83  $\mu$ s Detonation velocity: 7.79 km/s

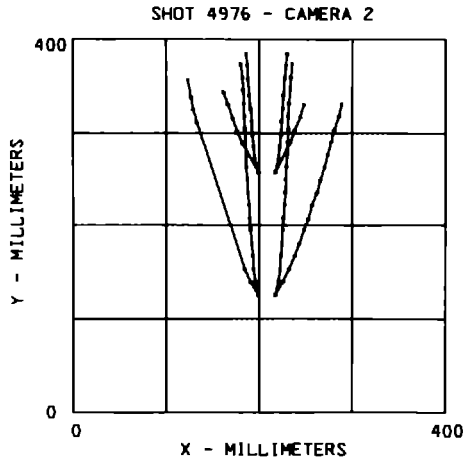
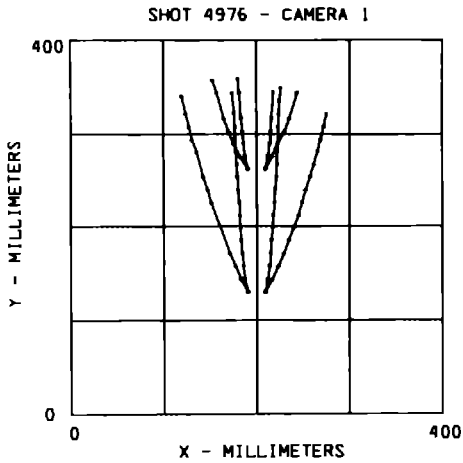

AQUARIUM DATA

SHOT 4976 - Camera 1  
EXPLOSIVE (PIPE) - WATER INTERFACE POSITIONS

Exposure 1

Left			Right		
<i>n</i>	<i>x</i> (mm)	<i>y</i> (mm)	<i>n</i>	<i>x</i> (mm)	<i>y</i> (mm)
1	179.9	357.2	8	217.8	343.6
2	181.2	343.6	9	216.2	316.4
3	183.1	316.4	10	215.3	302.8
4	184.5	302.8	11	213.7	289.2
5	185.8	289.2	12	212.2	275.5
6	187.4	275.5	13	209.0	261.9
7	190.8	261.9			

Exposure 2

Left			Right		
<i>n</i>	<i>x</i> (mm)	<i>y</i> (mm)	<i>n</i>	<i>x</i> (mm)	<i>y</i> (mm)
14	173.9	342.5	30	226.1	348.3
15	175.8	321.2	31	224.7	334.6
16	176.5	307.6	32	223.9	321.0
17	176.6	294.0	33	223.0	307.4
18	177.4	280.4	34	222.0	280.6
19	178.4	266.8	35	221.7	266.9
20	179.2	253.1	36	221.0	253.3
21	180.2	239.5	37	220.1	239.7
22	181.0	225.9	38	219.1	226.1
23	181.7	212.3	39	218.2	212.4
24	182.7	198.7	40	217.4	198.8
25	183.6	185.0	41	216.2	185.1
26	184.9	171.4	42	215.3	171.4
27	186.1	157.8	43	214.0	157.8
28	187.4	144.1	44	212.2	144.1
29	190.8	130.5	45	209.0	130.5

## SHOCK FRONT POSITIONS

## Exposure 1

Left			Right		
<i>n</i>	<i>x</i> (mm)	<i>y</i> (mm)	<i>n</i>	<i>x</i> (mm)	<i>y</i> (mm)
46	152.5	356.6	53	244.2	343.8
47	157.0	343.6	54	235.1	316.5
48	164.5	316.4	55	229.8	302.8
49	170.2	302.8	56	222.9	289.2
50	175.2	289.2	57	216.8	275.6
51	182.1	275.5	58	209.0	261.9
52	190.8	261.9			

## Exposure 2

Left			Right		
<i>n</i>	<i>x</i> (mm)	<i>y</i> (mm)	<i>n</i>	<i>x</i> (mm)	<i>y</i> (mm)
59	119.4	340.0	71	275.4	321.3
60	124.3	321.5	72	272.1	307.6
61	127.2	307.9	73	268.8	294.0
62	130.8	294.2	74	265.0	280.4
63	135.2	280.6	75	261.1	266.8
64	142.8	253.3	76	257.0	253.2
65	147.5	239.7	77	252.7	239.5
66	151.5	226.1	78	248.4	226.0
67	171.5	171.5	79	244.4	212.3
68	177.5	157.8	80	239.7	198.7
69	183.3	144.2	81	234.5	185.1
70	190.8	130.5	82	229.0	171.4
			83	223.1	157.8
			84	216.8	144.2
			85	209.0	130.5

AQUARIUM DATA

SHOT 4976 - Camera 2  
EXPLOSIVE (PIPE) - WATER INTERFACE POSITIONS

Exposure 1

Left			Right		
<i>n</i>	<i>x</i> (mm)	<i>y</i> (mm)	<i>n</i>	<i>x</i> (mm)	<i>y</i> (mm)
1	185.8	384.0	11	230.2	384.0
2	187.1	370.4	12	228.4	370.4
3	188.1	356.7	13	227.3	356.7
4	189.3	339.2	14	226.3	339.1
5	190.6	325.6	15	225.3	325.5
6	191.7	311.9	16	224.1	311.9
7	192.6	298.3	17	223.2	298.2
8	194.1	284.7	18	222.1	284.6
9	195.6	271.0	19	220.7	271.0
10	199.2	257.4	20	217.1	257.4

Exposure 2

Left			Right		
<i>n</i>	<i>x</i> (mm)	<i>y</i> (mm)	<i>n</i>	<i>x</i> (mm)	<i>y</i> (mm)
21	179.9	371.9	40	235.6	371.9
22	181.7	358.2	41	234.0	358.3
23	182.5	344.6	42	233.1	344.6
24	183.2	331.0	43	232.3	331.0
25	184.0	317.3	44	231.5	317.3
26	184.5	303.7	45	231.3	303.7
27	185.2	290.0	46	230.8	290.0
28	185.8	276.4	47	230.1	276.4
29	186.3	262.7	48	229.5	262.7
30	187.4	249.1	49	228.8	249.1
31	188.3	235.4	50	228.0	235.4
32	189.0	221.8	51	227.0	221.8
33	189.8	208.1	52	226.2	208.1
34	190.8	194.5	53	225.4	194.5
35	191.7	180.8	54	224.6	180.8
36	193.0	167.2	55	223.5	167.2
37	194.0	153.6	56	222.4	153.6
38	195.8	139.9	57	220.4	139.9
39	199.2	126.3	58	217.1	126.3

## SHOCK FRONT POSITIONS

## Exposure 1

Left			Right		
<i>n</i>	<i>x</i> (mm)	<i>y</i> (mm)	<i>n</i>	<i>x</i> (mm)	<i>y</i> (mm)
59	161.6	343.5	65	248.3	330.1
60	166.6	329.8	66	244.2	316.4
61	171.0	316.2	67	238.3	302.8
62	175.8	302.6	68	233.2	289.1
63	182.1	288.9	69	217.1	257.4
64	199.2	257.4			

## Exposure 2

Left			Right		
<i>n</i>	<i>x</i> (mm)	<i>y</i> (mm)	<i>n</i>	<i>x</i> (mm)	<i>y</i> (mm)
70	123.0	355.8	77	288.4	330.8
71	126.4	338.3	78	285.0	317.2
72	129.2	324.6	79	280.9	303.6
73	133.0	310.9	80	277.2	290.0
74	184.5	153.6	81	273.7	276.4
75	190.8	139.9	82	269.8	262.7
76	199.2	126.3	83	266.2	249.1
			84	261.7	235.4
			85	256.9	221.8
			86	253.0	208.1
			87	248.2	194.5
			88	243.2	180.9
			89	238.1	167.2
			90	232.3	153.6
			91	225.5	139.9
			92	217.1	126.3

**AQUARIUM DATA**

**Material:** RDX/"Fairy dust"      **Shot no.:** C-4730

**Experimenters:** B. G. Craig and M. M. Stinecipher      **Date:** October 13, 1977

**Charge diameter:** 2.54 cm      **Charge length:** 30.5 cm

**Initial density:** 1.718 g/cm<sup>3</sup>      **Temperature:** 297 K

**Confinement:** Bare charge in water

**Booster:** One SE-1 detonator, one PBX-9407 pellet, and a 2.5-cm-diam by 2.5-cm-long Comp B-3 charge

**Exposures of image intensifier camera:** Two

**Time between exposures:** 16.73  $\mu$ s      **Detonation velocity:** 8.52 km/s

**Notes:** Composition (1.38 moles ammonium nitrate/1.0 moles ADNT/1.5 moles RDX).

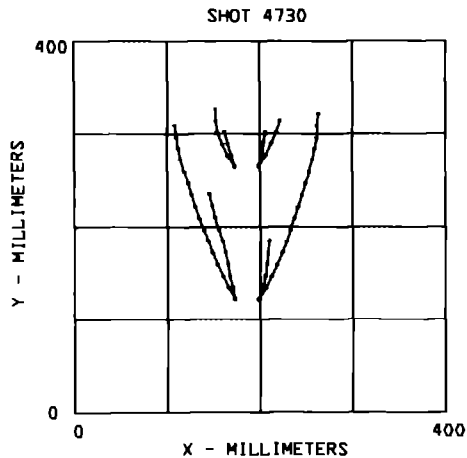

SHOT 4730  
EXPLOSIVE (PIPE) - WATER INTERFACE POSITIONS

Exposure 1

Left			Right		
<i>n</i>	<i>x</i> (mm)	<i>y</i> (mm)	<i>n</i>	<i>x</i> (mm)	<i>y</i> (mm)
1	161.7	301.8	5	206.3	302.2
2	165.4	289.3	6	204.1	289.7
3	169.6	276.9	7	202.4	277.3
4	173.2	264.3	8	199.0	264.8

Exposure 2

Left			Right		
<i>n</i>	<i>x</i> (mm)	<i>y</i> (mm)	<i>n</i>	<i>x</i> (mm)	<i>y</i> (mm)
9	145.1	234.4	19	210.2	184.4
10	148.5	221.9	20	208.8	171.9
11	152.1	209.4	21	207.5	159.5
12	155.4	196.9	22	206.0	147.0
13	159.0	184.4	23	203.2	134.5
14	162.6	171.9	24	198.9	122.0
15	165.4	159.5			
16	167.2	147.0			
17	170.8	134.5			
18	173.3	122.0			

SHOCK FRONT POSITIONS

Exposure 1

Left			Right		
<i>n</i>	<i>x</i> (mm)	<i>y</i> (mm)	<i>n</i>	<i>x</i> (mm)	<i>y</i> (mm)
25	152.3	326.8	31	222.3	314.7
26	152.7	314.3	32	218.2	302.2
27	153.7	301.8	33	212.9	289.7
28	159.0	289.3	34	206.4	277.3
29	165.1	276.9	35	199.0	264.8
30	173.2	264.3			



## AQUARIUM DATA

## Exposure 2

Left			Right		
<i>n</i>	<i>x</i> (mm)	<i>y</i> (mm)	<i>n</i>	<i>x</i> (mm)	<i>y</i> (mm)
36	108.9	309.3	52	263.4	321.2
37	109.9	296.8	53	262.2	308.7
38	111.7	284.4	54	261.8	296.3
39	114.9	271.9	55	259.2	283.9
40	118.3	259.4	56	256.7	271.4
41	122.4	246.9	57	253.2	259.0
42	126.0	234.4	58	249.4	246.5
43	130.3	221.9	59	245.6	234.1
44	134.9	209.4	60	241.4	221.6
45	139.6	196.9	61	237.5	209.2
46	144.1	184.4	62	232.9	196.7
47	148.9	171.9	63	228.4	184.2
48	154.3	159.5	64	223.8	171.8
49	160.1	147.0	65	218.7	159.3
50	166.2	134.5	66	212.9	146.9
51	173.3	122.0	67	206.5	134.4
			68	198.9	122.0

AQUARIUM DATA

**Material:** Stratablast-C    **Shot no.:** C-4771

**Experimenter:** T. E. Gould    **Date:** April 19, 1978

**Charge diameter:** 19.6 cm    **Charge length:** 151.8 cm

**Initial density:** 1.188 g/cm<sup>3</sup>    **Temperature:** 297 K

**Confinement:** Clay pipe, 2.3-cm wall, in water

**Booster:** One 1E23 detonator, one P-040 lens, and a 20.32-cm-diam by 2.54-cm-long TNT charge

**Exposures of image intensifier camera:** Two

**Time between exposures:** 63.31  $\mu$ s    **Detonation velocity:** 3.7 km/s

**Notes:** Stratablast - C is manufactured by Energy Sciences and Consultants, Inc., Biwabik, Minnesota.

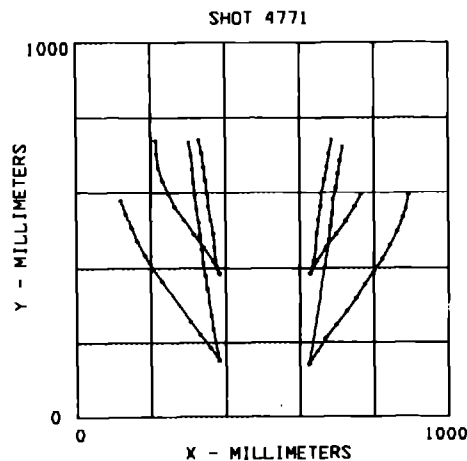

AQUARIUM DATA

SHOT 4771  
EXPLOSIVE (PIPE) - WATER INTERFACE POSITIONS

Exposure 1

Left			Right		
<i>n</i>	<i>x (mm)</i>	<i>y (mm)</i>	<i>n</i>	<i>x (mm)</i>	<i>y (mm)</i>
1	384.4	383.2	12	627.7	382.6
2	373.7	419.0	13	638.5	418.6
3	369.3	454.6	14	643.7	454.4
4	365.9	490.2	15	645.8	489.9
5	360.3	526.1	16	649.2	525.6
6	355.8	561.8	17	656.8	561.4
7	351.1	597.5	18	659.1	597.0
8	346.8	633.0	19	666.9	632.6
9	341.8	668.7	20	672.5	668.3
10	336.2	704.4	21	678.2	704.1
11	328.8	740.1	22	685.4	739.7

Exposure 2

Left			Right		
<i>n</i>	<i>x (mm)</i>	<i>y (mm)</i>	<i>n</i>	<i>x (mm)</i>	<i>y (mm)</i>
23	383.7	150.2	39	625.7	139.9
24	367.0	234.4	40	677.6	471.2
25	361.3	270.2	41	682.4	506.8
26	355.3	305.9	42	687.5	542.5
27	351.3	341.5	43	690.6	578.2
28	345.9	377.1	44	697.8	613.9
29	340.5	412.9	45	703.4	649.6
30	336.5	448.6	46	709.1	685.2
31	332.2	484.2	47	715.4	721.0
32	327.9	519.8			
33	322.9	555.6			
34	319.0	591.3			
35	315.4	626.8			
36	311.5	662.5			
37	307.7	698.3			
38	302.3	733.9			

## SHOCK FRONT POSITIONS

## Exposure 1

Left			Right		
<i>n</i>	<i>x</i> (mm)	<i>y</i> (mm)	<i>n</i>	<i>x</i> (mm)	<i>y</i> (mm)
48	384.4	383.2	59	627.7	382.6
49	368.2	419.0	60	644.2	418.6
50	341.1	454.6	61	671.2	454.4
51	314.3	490.2	62	698.9	490.0
52	289.4	525.9	63	724.7	525.6
53	265.1	561.7	64	748.0	561.4
54	248.2	597.3	65	766.7	597.0
55	232.0	632.9			
56	219.8	668.6			
57	215.7	704.3			
58	213.8	740.0			

## Exposure 2

Left			Right		
<i>n</i>	<i>x</i> (mm)	<i>y</i> (mm)	<i>n</i>	<i>x</i> (mm)	<i>y</i> (mm)
66	383.7	150.2	77	625.7	139.9
67	359.6	185.9	78	647.2	175.5
68	332.3	221.4	79	669.7	211.3
69	305.2	257.2	80	698.9	247.0
70	229.7	364.1	81	726.2	282.7
71	204.1	399.9	82	752.4	318.5
72	183.4	435.6	83	777.2	354.3
73	163.6	471.4	84	800.1	390.1
74	148.2	507.0	85	822.5	425.8
75	132.7	542.7	86	843.6	461.5
76	119.4	578.4	87	861.7	497.1
			88	877.6	532.7
			89	886.0	557.1
			90	893.2	592.7

**AQUARIUM DATA**

**Material:** TAL-1005E      **Shot no.:** C-4791

**Experimenters:** J. B. Ramsay and T. E. Gould      **Date:** May 26, 1978

**Charge diameter:** 2.5 cm      **Charge length:** 57.2 cm

**Initial density:** 1.304 g/cm<sup>3</sup>      **Temperature:** 298 K

**Confinement:** Teflon, 0.5-cm wall with 3.49-cm o.d., in water

**Booster:** One SE-1 detonator, one 1.3-cm-diam by 1.3-cm-long PBX-9407 pellet, and a 2.5-cm-diam by 2.8-cm-long PBX-9404 charge

**Exposures of image intensifier camera:** Two

**Time between exposures:** 37.1  $\mu$ s

**Detonation velocity:** 6.2 km/s

**Notes:** TAL-1005E is manufactured by Talley-Frac Corporation, Mesa, Arizona.

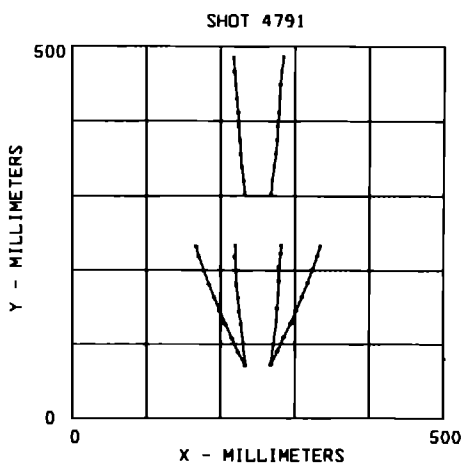

SHOT 4791  
EXPLOSIVE (PIPE) - WATER INTERFACE POSITIONS

Exposure 1

Left			Right		
<u>n</u>	<u>x (mm)</u>	<u>y (mm)</u>	<u>n</u>	<u>x (mm)</u>	<u>y (mm)</u>
1	232.8	300.9	12	267.6	301.1
2	230.5	319.2	13	269.4	319.5
3	228.6	337.5	14	271.6	337.8
4	226.8	355.9	15	274.2	356.1
5	225.5	374.3	16	275.8	374.5
6	223.8	392.6	17	277.0	392.8
7	223.1	410.9	18	278.0	411.2
8	221.8	429.3	19	278.9	429.6
9	220.3	447.7	20	280.4	447.9
10	218.6	466.0	21	281.8	466.2
11	217.5	484.3	22	283.8	484.6

Exposure 2

Left			Right		
<u>n</u>	<u>x (mm)</u>	<u>y (mm)</u>	<u>n</u>	<u>x (mm)</u>	<u>y (mm)</u>
23	233.0	71.7	31	267.2	72.1
24	227.5	126.0	32	274.8	129.8
25	224.7	144.4	33	275.6	148.3
26	223.1	162.7	34	277.3	166.6
27	221.0	181.0	35	278.2	184.9
28	221.1	199.3	36	278.5	203.2
29	219.5	217.7	37	280.5	221.6
30	219.8	232.4	38	281.6	232.5

AQUARIUM DATA

SHOCK FRONT POSITIONS

Exposure 2

Left			Right		
<i>n</i>	<i>x</i> (mm)	<i>y</i> (mm)	<i>n</i>	<i>x</i> (mm)	<i>y</i> (mm)
39	233.0	71.7	49	267.2	72.1
40	223.3	90.2	50	276.7	90.5
41	215.4	108.5	51	285.3	108.8
42	206.9	126.8	52	293.8	127.1
43	199.0	145.2	53	301.9	145.5
44	192.0	163.5	54	309.2	163.8
45	184.4	181.8	55	316.7	182.1
46	177.8	200.2	56	232.1	200.5
47	171.2	218.6	57	330.4	218.9
48	166.7	232.9	58	334.4	232.2

AQUARIUM DATA

Material: TAL-1005E Shot no.: C-4805

Experimenters: T. E. Gould and J. B. Ramsay Date: July 25, 1978

Charge diameter: 2.5 cm Charge length: 57.2 cm

Initial density: 1.304 g/cm<sup>3</sup> Temperature: 297 K

Confinement: Teflon tube, 1.75-cm wall with 6.0-cm o.d, in water

Booster: One SE-1 detonator and one 2.5-cm-diam by 2.8-cm-long PBX-9404 pellet

Exposures of image intensifier camera: Two

Time between exposures: Camera 1, 42.7  $\mu$ s; Camera 2, 38.37  $\mu$ s

Detonation velocity: 6.0 km/s

Notes: TAL-1005E is manufactured by Talley-Frac Corporation, Mesa, Arizona.

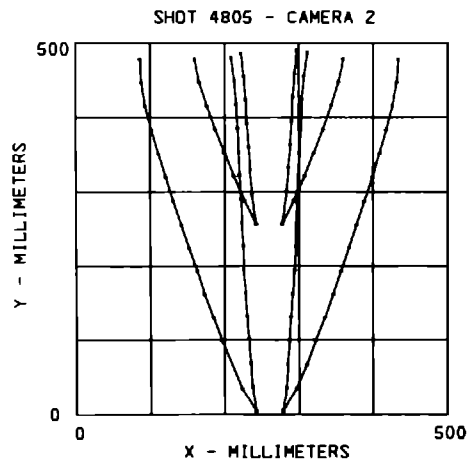
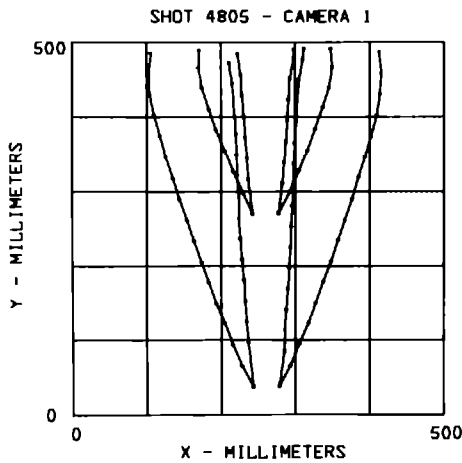



AQUARIUM DATA

SHOT 4805 - Camera 1  
EXPLOSIVE (PIPE) - WATER INTERFACE POSITIONS

Exposure 1

Left			Right		
<i>n</i>	<i>x</i> (mm)	<i>y</i> (mm)	<i>n</i>	<i>x</i> (mm)	<i>y</i> (mm)
1	222.8	484.2	9	298.7	490.1
2	226.3	456.2	10	297.1	478.6
3	228.7	428.2	11	292.6	450.7
4	230.5	400.2	12	291.0	422.6
5	232.2	372.2	13	289.2	394.6
6	235.1	344.2	14	287.4	366.7
7	236.7	316.2	15	285.4	338.6
8	242.8	270.6	16	282.9	310.6
			17	277.4	272.0

Exposure 2

Left			Right		
<i>n</i>	<i>x</i> (mm)	<i>y</i> (mm)	<i>n</i>	<i>x</i> (mm)	<i>y</i> (mm)
18	211.0	472.3	32	311.7	490.9
19	214.7	444.3	33	310.4	477.0
20	220.1	376.6	34	304.7	449.0
21	221.0	348.5	35	302.4	421.0
22	222.0	320.5	36	300.8	393.0
23	224.1	292.5	37	299.5	365.0
24	224.5	264.5	38	298.1	337.0
25	226.1	236.5	39	297.1	309.0
26	228.5	208.5	40	295.7	281.0
27	230.5	180.5	41	294.4	253.0
28	232.5	152.5	42	293.2	225.0
29	234.5	124.5	43	291.8	197.0
30	236.9	96.5	44	289.9	169.0
31	243.0	38.1	45	287.8	141.0
			46	286.2	113.0
			47	284.6	85.0
			48	278.1	38.9

## SHOCK FRONT POSITIONS

## Exposure 1

Left			Right		
<i>n</i>	<i>x</i> (mm)	<i>y</i> (mm)	<i>n</i>	<i>x</i> (mm)	<i>y</i> (mm)
49	170.7	489.0	58	347.8	491.4
50	169.6	466.7	59	349.8	468.1
51	174.5	438.8	60	345.9	440.1
52	183.1	410.7	61	336.7	412.1
53	193.5	382.7	62	327.0	384.1
54	204.8	354.7	63	316.4	356.1
55	216.7	326.7	64	304.8	328.1
56	229.1	298.8	65	292.3	300.1
57	242.8	270.6	66	277.4	272.0

## Exposure 2

Left			Right		
<i>n</i>	<i>x</i> (mm)	<i>y</i> (mm)	<i>n</i>	<i>x</i> (mm)	<i>y</i> (mm)
67	106.2	486.1	84	413.1	487.0
68	103.5	458.2	85	416.2	459.0
69	104.5	430.2	86	413.8	431.0
70	110.0	402.1	87	410.4	402.9
71	118.4	374.2	88	402.8	375.0
72	126.0	346.1	89	394.2	346.9
73	135.3	318.1	90	384.8	319.0
74	144.1	290.2	91	376.4	291.0
75	153.8	262.1	92	367.0	262.9
76	163.1	234.2	93	357.7	235.0
77	173.1	206.1	94	348.0	206.9
78	183.1	178.1	95	337.7	178.9
79	193.6	150.2	96	327.3	151.0
80	204.6	122.1	97	317.2	122.9
81	215.9	94.2	98	305.1	95.0
82	228.7	66.1	99	293.1	66.9
83	243.0	38.1	100	278.1	38.9

AQUARIUM DATA

SHOT 4805 - Camera 2  
 EXPLOSIVE (PIPE) - WATER INTERFACE POSITIONS

Exposure 1

Left			Right		
<i>n</i>	<i>x</i> (mm)	<i>y</i> (mm)	<i>n</i>	<i>x</i> (mm)	<i>y</i> (mm)
1	222.8	486.2	9	297.4	489.6
2	226.0	454.6	10	293.8	458.1
3	228.0	423.0	11	291.9	426.4
4	230.0	391.5	12	290.0	394.9
5	232.2	359.8	13	288.0	363.2
6	234.5	328.2	14	286.0	331.7
7	236.9	296.6	15	283.7	300.0
8	242.7	257.5	16	277.7	257.5

Exposure 2

Left			Right		
<i>n</i>	<i>x</i> (mm)	<i>y</i> (mm)	<i>n</i>	<i>x</i> (mm)	<i>y</i> (mm)
17	209.3	479.6	33	311.4	486.4
18	213.5	448.0	34	306.8	454.8
19	216.0	416.4	35	303.9	423.2
20	217.9	384.9	36	302.1	383.6
21	219.2	353.2	37	300.9	352.0
22	220.3	321.7	38	299.4	320.5
23	222.5	290.0	39	297.7	288.8
24	223.6	258.5	40	296.4	257.3
25	224.7	226.8	41	295.5	225.6
26	226.0	195.3	42	293.9	194.0
27	228.5	163.7	43	291.6	162.5
28	230.1	132.0	44	289.2	130.8
29	232.5	100.5	45	287.5	99.3
30	234.6	68.9	46	285.4	67.7
31	237.1	37.3	47	283.5	36.1
32	242.5	4.0	48	278.2	4.0

## SHOCK FRONT POSITIONS

## Exposure 1

Left			Right		
<i>n</i>	<i>x</i> (mm)	<i>y</i> (mm)	<i>n</i>	<i>x</i> (mm)	<i>y</i> (mm)
49	160.1	478.7	57	359.9	478.8
50	166.0	447.1	58	353.6	447.2
51	176.3	415.4	59	343.6	415.5
52	187.7	384.0	60	332.1	384.0
53	199.9	352.4	61	320.4	352.4
54	212.5	320.8	62	307.5	320.8
55	226.4	289.2	63	293.1	289.2
56	242.7	257.5	64	277.7	257.5

## Exposure 2

Left			Right		
<i>n</i>	<i>x</i> (mm)	<i>y</i> (mm)	<i>n</i>	<i>x</i> (mm)	<i>y</i> (mm)
65	86.4	478.4	80	433.8	478.0
66	88.0	446.4	81	431.6	446.4
67	93.7	414.8	82	425.9	414.8
68	101.9	383.2	83	417.6	383.2
69	110.9	351.6	84	408.4	351.6
70	121.1	320.0	85	398.8	320.0
71	130.9	288.4	86	388.1	288.4
72	141.6	256.8	87	377.8	256.8
73	151.7	225.2	88	367.5	225.2
74	163.0	193.6	89	356.9	193.6
75	173.5	162.0	90	345.8	162.0
76	184.8	130.4	91	334.7	130.4
77	196.7	98.9	92	322.9	98.9
78	223.5	35.7	93	310.7	67.2
79	242.5	4.0	94	296.9	35.7
			95	278.2	4.0

**AQUARIUM DATA**

**Material:** TNT Flake #1      **Shot no.:** C-4692

**Experimenter:** G. F. Lederman      **Date:** April 8, 1977

**Charge diameter:** 9.85 cm      **Charge length:** 121.1 cm

**Initial density:** 0.762 g/cm<sup>3</sup>      **Temperature:** 297 K

**Confinement:** Clay pipe, 1.63-cm wall with 13.11-cm o.d., in water

**Booster:** One SE-1 detonator, one tetryl pellet, and a 10-cm-diam by 2.5-cm-long TNT charge

**Exposures of image intensifier camera:** Three

**Time between exposures:** 58.97 and 59.02  $\mu$ s      **Detonation velocity:** 3.91 km/s

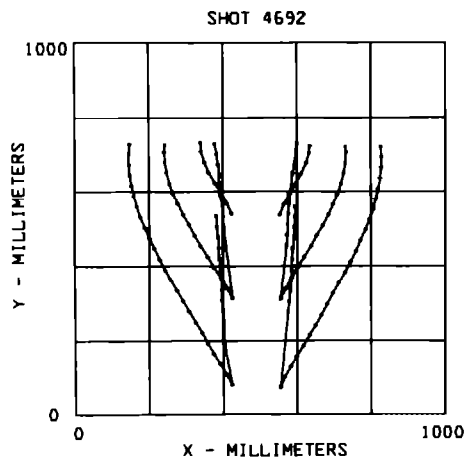

SHOT 4692  
EXPLOSIVE (PIPE) - WATER INTERFACE POSITIONS

Exposure 2

Left			Right		
<i>n</i>	<i>x</i> (mm)	<i>y</i> (mm)	<i>n</i>	<i>x</i> (mm)	<i>y</i> (mm)
1	377.5	728.8	11	600.2	728.4
2	383.0	700.7	12	597.6	709.7
3	386.1	672.5	13	588.6	647.7
4	389.2	644.3	14	579.1	566.5
5	390.6	616.0	15	577.3	538.2
6	393.7	587.9	16	574.9	510.1
7	397.9	559.9	17	572.9	482.1
8	400.3	531.6	18	571.4	454.1
9	401.9	503.4	19	554.3	311.9
10	414.6	312.8			

Exposure 3

Left			Right		
<i>n</i>	<i>x</i> (mm)	<i>y</i> (mm)	<i>n</i>	<i>x</i> (mm)	<i>y</i> (mm)
20	380.9	531.3	34	595.4	557.5
21	383.1	503.2	35	595.0	529.2
22	386.5	475.1	36	592.9	501.0
23	389.0	446.9	37	591.4	472.9
24	390.3	418.6	38	589.0	444.7
25	393.3	390.4	39	586.7	416.5
26	396.4	362.3	40	584.6	388.3
27	397.4	334.1	41	583.5	360.2
28	397.2	305.9	42	581.0	332.0
29	399.3	277.7	43	578.3	303.7
30	400.9	249.6	44	575.8	275.7
31	402.3	221.3	45	554.3	73.3
32	404.1	193.1			
33	424.1	80.7			

AQUARIUM DATA

SHOCK FRONT POSITIONS

Exposure 1

Left			Right		
<i>n</i>	<i>x</i> (mm)	<i>y</i> (mm)	<i>n</i>	<i>x</i> (mm)	<i>y</i> (mm)
46	339.7	732.5	54	634.9	722.6
47	341.9	708.6	55	633.5	705.4
48	349.3	680.4	56	625.5	677.3
49	362.0	652.2	57	612.3	649.1
50	378.0	624.0	58	595.9	620.8
51	394.7	595.9	59	579.5	592.7
52	409.4	567.7	60	565.5	564.6
53	423.9	539.4	61	553.1	536.3

Exposure 2

Left			Right		
<i>n</i>	<i>x</i> (mm)	<i>y</i> (mm)	<i>n</i>	<i>x</i> (mm)	<i>y</i> (mm)
62	243.8	726.2	78	731.7	720.8
63	242.1	707.4	79	732.7	706.5
64	243.2	679.2	80	732.3	678.3
65	247.9	651.0	81	727.1	650.1
66	254.8	622.8	82	719.8	621.9
67	265.3	594.7	83	710.0	593.8
68	277.8	566.5	84	698.0	565.6
69	291.4	538.3	85	684.8	537.4
70	307.7	510.0	86	670.3	509.1
71	323.0	481.9	87	653.5	481.0
72	340.8	453.8	88	637.8	452.9
73	357.5	425.5	89	620.0	424.6
74	374.5	397.3	90	602.3	396.4
75	393.3	369.2	91	584.6	368.3
76	410.4	341.0	92	569.2	340.1
77	424.6	312.8	93	554.3	311.9

## AQUARIUM DATA

## Exposure 3

Left			Right		
<i>n</i>	<i>x</i> (mm)	<i>y</i> (mm)	<i>n</i>	<i>x</i> (mm)	<i>y</i> (mm)
94	148.8	729.0	118	826.6	719.4
95	147.2	700.9	119	827.9	693.5
96	146.4	672.7	120	827.7	665.3
97	149.1	644.4	121	825.5	637.0
98	153.1	616.2	122	820.0	608.9
99	159.2	588.1	123	814.0	580.8
100	167.3	559.9	124	806.0	552.5
101	176.4	531.6	125	797.3	524.3
102	187.8	503.5	126	784.4	496.1
103	201.0	475.4	127	772.2	468.0
104	214.4	447.2	128	760.4	439.8
105	228.9	418.9	129	744.7	411.6
106	243.9	390.7	130	730.3	383.4
107	258.7	362.7	131	713.5	355.3
108	275.6	334.4	132	696.6	327.0
109	291.5	306.2	133	682.4	298.8
110	307.7	278.0	134	667.0	270.7
111	324.9	249.9	135	650.6	242.5
112	342.7	221.7	136	633.6	214.3
113	359.1	193.4	137	617.1	186.1
114	375.7	165.3	138	599.1	157.9
115	392.1	137.1	139	582.7	129.7
116	409.1	108.9	140	567.4	101.5
117	424.1	80.7	141	554.3	73.3



**AQUARIUM DATA**

**Material:** TNT Flake #1      **Shot no.:** C-4695

**Experimenter:** G. F. Lederman      **Date:** April 15, 1977

**Charge diameter:** 9.81 cm      **Charge length:** 121.0 cm

**Initial density:** 0.849 g/cm<sup>3</sup>      **Temperature:** 297 K

**Confinement:** Clay pipe, 15.78-cm wall with 41.37-cm o.d., in water

**Booster:** One SE-1 detonator, one tetryl pellet, and a 2.5-cm-diam by 10-cm-long TNT charge

**Exposures of image intensifier camera:** Two

**Time between exposures:** 82.6  $\mu$ s      **Detonation velocity:** 4.29 km/s

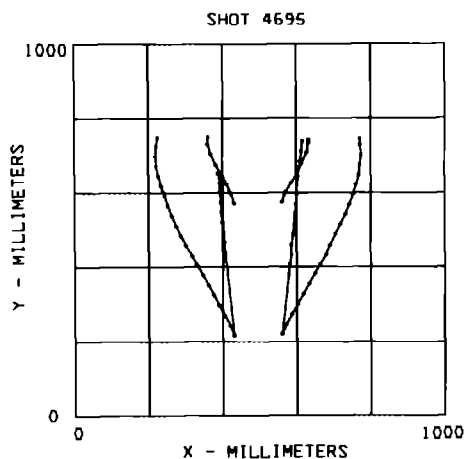

**SHOT 4695**  
**EXPLOSIVE (PIPE) - WATER INTERFACE POSITIONS**

Exposure 2

Left			Right		
<i>n</i>	<i>x</i> (mm)	<i>y</i> (mm)	<i>n</i>	<i>x</i> (mm)	<i>y</i> (mm)
1	388.5	653.2	11	616.5	738.9
2	391.3	626.5	12	613.4	712.1
3	393.1	599.8	13	609.7	685.4
4	395.1	573.1	14	600.7	621.3
5	397.4	546.4	15	599.2	594.5
6	400.0	519.7	16	597.6	567.7
7	402.5	492.9	17	595.6	540.9
8	404.7	466.2	18	592.6	514.0
9	407.2	439.5	19	590.7	487.2
10	431.4	217.1	20	587.4	460.4
			21	585.1	433.6
			22	580.4	406.8
			23	578.9	379.9
			24	562.1	221.0

**SHOCK FRONT POSITIONS**

Exposure 1

Left			Right		
<i>n</i>	<i>x</i> (mm)	<i>y</i> (mm)	<i>n</i>	<i>x</i> (mm)	<i>y</i> (mm)
25	361.4	749.8	33	633.1	745.5
26	360.4	732.0	34	633.0	736.0
27	368.8	705.1	35	627.5	709.2
28	381.7	678.4	36	615.7	682.4
29	396.1	651.6	37	601.1	655.6
30	410.8	624.7	38	585.3	628.7
31	421.7	597.8	39	569.6	601.9
32	431.7	571.0	40	560.4	575.1

AQUARIUM DATA

Exposure 2

Left			Right		
<i>n</i>	<i>x</i> (mm)	<i>y</i> (mm)	<i>n</i>	<i>x</i> (mm)	<i>y</i> (mm)
41	225.1	750.0	62	771.1	746.0
42	221.8	726.8	63	772.4	730.6
43	220.8	699.9	64	774.2	703.8
44	221.4	673.2	65	771.9	677.0
45	226.5	646.4	66	767.6	650.2
46	234.1	619.5	67	760.7	623.3
47	242.7	592.7	68	753.0	596.5
48	252.4	565.9	69	742.3	569.7
49	263.8	539.1	70	731.4	542.9
50	274.8	512.2	71	718.8	516.1
51	288.6	485.4	72	705.7	489.2
52	301.6	458.6	73	691.4	462.4
53	317.1	431.8	74	677.5	435.7
54	330.7	404.9	75	663.3	408.8
55	346.2	378.1	76	648.4	381.2
56	361.2	351.3	77	634.1	355.1
57	376.4	324.5	78	618.8	328.3
58	390.8	297.6	79	603.1	301.4
59	406.8	270.8	80	587.9	274.6
60	422.4	244.0	81	572.5	247.9
61	431.0	217.1	82	562.1	221.0

AQUARIUM DATA

Material: X-0320 Shot no.: C-5034

Experimenter: S. Goldstein Date: July 15, 1980

Charge diameter: 2.5 cm Charge length: 32.4 cm

Initial density: 1.880 g/cm<sup>3</sup> Temperature: 304 K

Confinement: Bare charge in water

Booster: One RP-1/PT detonator, one PBX-9407 pellet, and a 2.5-cm-diam by 2.5-cm-long PBX-9404 pellet

Exposures of image intensifier camera: Two

Time between exposures: 15.32  $\mu$ s Detonation velocity: 8.22 km/s

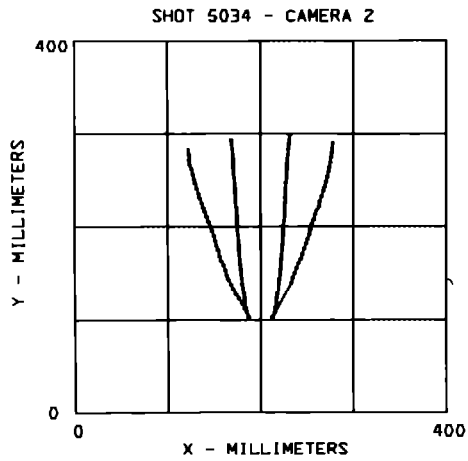
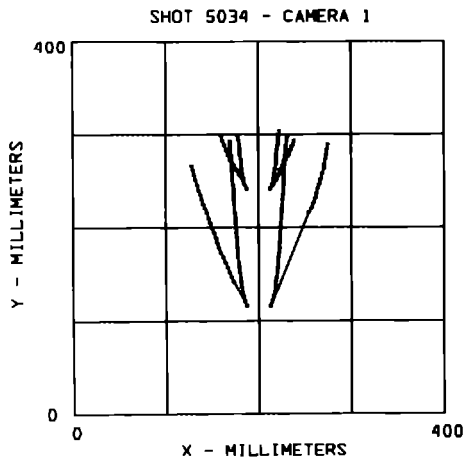

AQUARIUM DATA

SHOT 5034 - Camera 1  
 EXPLOSIVE (PIPE) - WATER INTERFACE POSITIONS

Exposure 1

Left			Right		
<i>n</i>	<i>x</i> (mm)	<i>y</i> (mm)	<i>n</i>	<i>x</i> (mm)	<i>y</i> (mm)
1	177.9	298.7	13	222.4	303.9
2	178.4	293.6	14	221.8	298.7
3	179.0	288.4	15	221.4	293.5
4	179.7	283.2	16	220.8	288.3
5	180.3	278.0	17	220.3	283.2
6	181.0	272.8	18	219.6	278.0
7	181.6	267.7	19	219.1	272.8
8	182.2	262.4	20	218.5	267.7
9	182.9	257.2	21	217.7	262.5
10	183.8	252.1	22	216.9	257.3
11	184.6	246.7	23	216.1	252.1
12	187.3	241.7	24	215.1	246.9
			25	212.7	241.7

Exposure 2

Left			Right		
<i>n</i>	<i>x</i> (mm)	<i>y</i> (mm)	<i>n</i>	<i>x</i> (mm)	<i>y</i> (mm)
26	169.3	292.3	61	231.0	297.5
27	169.7	287.1	62	230.4	292.4
28	170.2	281.9	63	229.8	287.2
29	170.6	276.7	64	229.4	282.0
30	170.9	271.5	65	228.8	276.8
31	171.3	266.4	66	228.3	271.6
32	171.6	261.2	67	228.0	266.4
33	172.0	256.0	68	227.7	261.2
34	172.2	250.8	69	227.4	256.0
35	172.6	245.6	70	227.2	250.9
36	173.1	240.4	71	227.0	245.7
37	173.4	235.2	72	226.7	240.5
38	173.6	230.0	73	226.4	235.3
39	173.9	224.8	74	226.0	230.1
40	174.1	219.6	75	225.7	224.9
41	174.5	214.5	76	225.2	219.7
42	175.0	209.3	77	224.8	214.5

AQUARIUM DATA

43	175.4	204.1	78	224.5	209.3
44	175.9	198.9	79	224.2	204.1
45	176.3	193.7	80	223.9	198.9
46	176.5	188.5	81	223.5	193.8
47	176.9	183.3	82	223.2	188.6
48	177.3	178.1	83	222.8	183.4
49	177.7	172.9	84	222.4	178.2
50	178.2	167.8	85	222.1	173.0
51	178.8	162.6	86	221.5	167.8
52	179.4	157.4	87	221.0	162.6
53	179.9	152.2	88	220.5	157.4
54	180.5	147.0	89	219.7	152.2
55	181.1	141.8	90	219.0	147.0
56	181.8	136.6	91	218.3	141.9
57	182.4	131.4	92	217.7	136.7
58	183.7	126.2	93	217.0	131.5
59	185.1	121.0	94	216.0	126.3
60	187.3	115.8	95	214.7	121.1
			96	212.7	115.8

SHOCK FRONT POSITIONS

Exposure 1

Left			Right		
<u>n</u>	<u>x (mm)</u>	<u>y (mm)</u>	<u>n</u>	<u>x (mm)</u>	<u>y (mm)</u>
97	159.9	298.8	107	238.5	293.5
98	161.3	293.6	108	236.5	288.3
99	163.0	288.4	109	234.7	283.1
100	165.3	283.2	110	232.4	277.9
101	167.5	278.0	111	229.6	272.7
102	170.2	272.8	112	226.7	267.6
103	173.0	267.4	113	224.2	262.4
104	176.0	262.5	114	222.0	257.2
105	179.0	257.3	115	219.0	252.0
106	187.3	241.7	116	216.2	246.8
			117	212.7	241.7

## AQUARIUM DATA

## Exposure 2

Left			Right		
<u>n</u>	<u>x (mm)</u>	<u>y (mm)</u>	<u>n</u>	<u>x (mm)</u>	<u>y (mm)</u>
118	128.3	266.9	144	274.5	289.1
119	129.3	261.7	145	274.2	283.9
120	130.7	256.6	146	273.3	278.7
121	132.1	251.4	147	272.2	273.5
122	133.7	246.2	148	271.5	268.3
123	135.3	241.0	149	270.5	263.1
124	137.0	235.9	150	268.8	258.0
125	138.9	230.7	151	267.3	252.7
126	140.8	225.5	152	265.9	247.6
127	142.8	220.3	153	264.2	242.4
128	144.5	215.2	154	262.7	237.2
129	145.9	210.0	155	261.3	232.0
130	147.8	204.8	156	259.6	226.8
131	149.9	199.6	157	257.4	221.6
132	152.1	194.4	158	254.8	216.4
133	154.1	189.2	159	212.7	115.8
134	155.6	184.0			
135	157.4	178.8			
136	159.4	173.6			
137	162.0	168.4			
138	164.3	163.3			
139	166.5	158.1			
140	168.5	152.9			
141	170.8	147.7			
142	173.3	142.4			
143	187.3	115.8			

SHOT 5034 - Camera 2  
EXPLOSIVE (PIPE) - WATER INTERFACE POSITIONS

Exposure 1

Left			Right		
<i>n</i>	<i>x</i> (mm)	<i>y</i> (mm)	<i>n</i>	<i>x</i> (mm)	<i>y</i> (mm)
1	168.5	293.0	39	232.2	298.1
2	169.2	287.9	40	231.4	293.0
3	169.7	282.7	41	230.7	287.9
4	170.1	277.5	42	230.2	282.8
5	170.4	272.4	43	229.7	277.6
6	170.8	267.2	44	229.2	272.5
7	171.3	262.1	45	228.7	267.4
8	171.6	257.0	46	228.4	262.2
9	171.9	251.8	47	228.1	257.1
10	172.3	246.7	48	227.8	251.9
11	172.6	241.5	49	227.6	246.7
12	172.9	236.4	50	227.4	241.6
13	173.2	231.2	51	227.2	236.5
14	173.5	226.1	52	226.8	231.3
15	173.8	220.9	53	226.5	226.2
16	174.1	215.8	54	226.2	221.0
17	174.5	210.6	55	226.0	215.9
18	174.9	205.4	56	225.7	210.7
19	175.2	200.3	57	225.2	205.6
20	175.6	195.1	58	224.8	200.4
21	175.9	190.0	59	224.5	195.3
22	176.2	184.8	60	224.0	190.2
23	176.4	179.7	61	223.7	185.0
24	176.8	174.5	62	223.4	179.9
25	177.3	169.4	63	223.1	174.7
26	177.8	164.2	64	222.6	169.5
27	178.2	159.1	65	222.2	164.4
28	178.8	154.0	66	221.9	159.3
29	179.3	148.8	67	221.3	154.1
30	179.7	143.7	68	221.0	148.9
31	180.3	138.6	69	220.2	143.8
32	181.1	133.5	70	219.5	138.6
33	182.0	128.3	71	219.0	133.5
34	182.6	123.1	72	218.3	128.3



AQUARIUM DATA

35	183.3	118.0	73	217.6	123.1
36	184.1	112.8	74	216.9	118.0
37	185.4	107.7	75	216.0	112.9
38	187.3	102.5	76	215.1	107.7
			77	212.7	102.5

SHOCK FRONT POSITIONS

Exposure 1

Left			Right		
<i>n</i>	<i>x</i> (mm)	<i>y</i> (mm)	<i>n</i>	<i>x</i> (mm)	<i>y</i> (mm)
78	122.7	282.5	113	277.9	290.0
79	123.4	277.3	114	277.5	284.9
80	123.3	272.2	115	277.0	279.7
81	124.1	267.0	116	276.1	274.5
82	125.7	261.9	117	275.2	269.4
83	127.5	256.8	118	274.3	264.2
84	128.7	251.6	119	273.0	259.1
85	130.1	246.5	120	271.9	253.9
86	131.5	241.4	121	270.4	248.7
87	133.1	236.2	122	269.0	243.6
88	134.7	231.1	123	267.3	238.5
89	136.5	225.9	124	265.9	233.3
90	138.6	220.8	125	264.3	228.1
91	140.0	215.7	126	263.1	223.0
92	141.9	210.5	127	260.7	217.8
93	143.9	205.4	128	258.7	212.7
94	145.9	200.2	129	257.2	207.5
95	147.7	195.1	130	255.3	202.4
96	149.7	189.9	131	253.8	197.2
97	151.0	184.8	132	252.7	192.0
98	152.9	179.6	133	250.6	186.9
99	154.7	174.5	134	248.8	181.7
100	155.6	169.4	135	246.7	176.6
101	157.5	164.2	136	245.2	171.4
102	159.9	159.1	137	243.3	166.3
103	161.7	153.9	138	240.8	161.1
104	163.6	148.8	139	238.5	156.0
105	165.6	143.7	140	236.8	150.8
106	168.0	138.6	141	234.5	145.7

**AQUARIUM DATA**

107	170.7	133.4	142	233.0	140.6
108	173.6	128.3	143	212.7	102.5
109	176.8	123.1			
110	180.2	118.0			
111	182.8	112.9			
112	187.3	102.5			

**AQUARIUM DATA**

**Material:** X-0321      **Shot no.:** C-4992

**Experimenter:** S. Goldstein      **Date:** April 4, 1980

**Charge diameter:** 2.54 cm      **Charge length:** 32.3 cm

**Initial density:** 1.881 g/cm<sup>3</sup>      **Temperature:** 290 K

**Confinement:** Bare charge in water

**Booster:** One SE-1 detonator and one 2.5-cm-diam by 2.5-cm-long PBX-9407 pellet

**Exposures of image intensifier camera:** Two

**Time between exposures:** 17.12  $\mu$ s      **Detonation velocity:** 8.043 km/s

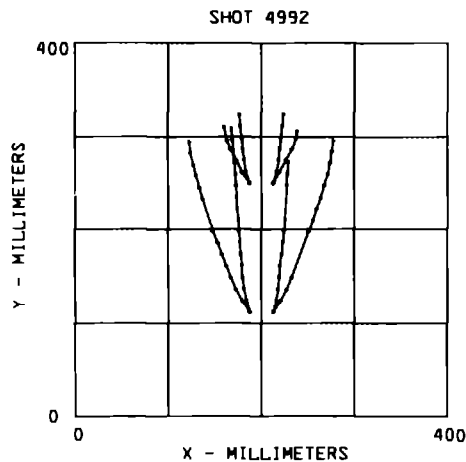

SHOT 4992  
EXPLOSIVE (PIPE) - WATER INTERFACE POSITIONS

Exposure 1

Left			Right		
<i>n</i>	<i>x</i> (mm)	<i>y</i> (mm)	<i>n</i>	<i>x</i> (mm)	<i>y</i> (mm)
1	176.5	322.7	8	223.7	323.5
2	177.5	310.5	9	222.6	311.2
3	179.0	298.2	10	221.2	298.9
4	180.2	286.0	11	220.2	286.7
5	181.7	273.7	12	218.4	274.5
6	183.5	261.5	13	216.4	262.3
7	187.3	249.2	14	212.7	250.0

Exposure 2

Left			Right		
<i>n</i>	<i>x</i> (mm)	<i>y</i> (mm)	<i>n</i>	<i>x</i> (mm)	<i>y</i> (mm)
15	167.7	308.1	32	228.9	271.8
16	169.3	295.9	33	227.9	259.5
17	170.1	283.7	34	227.0	247.3
18	171.2	271.4	35	225.0	210.5
19	171.8	259.2	36	224.4	198.2
20	172.4	247.0	37	223.2	185.9
21	173.2	234.7	38	222.2	173.6
22	174.1	222.5	39	220.2	161.4
23	175.3	210.2	40	219.6	149.1
24	176.1	198.0	41	218.3	136.8
25	177.1	185.8	42	216.2	124.6
26	177.9	173.5	43	212.7	112.3
27	179.1	161.2			
28	180.1	149.0			
29	181.5	136.8			
30	183.7	124.5			
31	187.3	112.3			

AQUARIUM DATA

SHOCK FRONT POSITIONS

Exposure 1

Left			Right		
<i>n</i>	<i>x</i> (mm)	<i>y</i> (mm)	<i>n</i>	<i>x</i> (mm)	<i>y</i> (mm)
44	159.8	310.5	50	238.8	306.2
45	163.1	296.2	51	237.8	299.1
46	167.4	286.0	52	233.3	286.8
47	173.4	273.7	53	226.9	274.5
48	179.5	261.5	54	219.2	262.3
49	187.3	249.3	55	212.7	250.0

Exposure 2

Left			Right		
<i>n</i>	<i>x</i> (mm)	<i>y</i> (mm)	<i>n</i>	<i>x</i> (mm)	<i>y</i> (mm)
56	122.4	294.4	70	277.5	296.1
57	123.7	282.2	71	275.8	283.9
58	126.6	269.9	72	273.7	271.7
59	129.8	257.7	73	271.2	259.4
60	133.3	245.5	74	267.5	247.2
61	136.9	233.2	75	263.7	234.9
62	147.8	198.1	76	259.1	222.7
63	153.3	285.8	77	255.2	210.4
64	157.7	173.5	78	251.4	198.2
65	162.4	161.3	79	232.5	149.1
66	167.0	149.1	80	227.6	136.8
67	172.6	136.8	81	220.8	124.6
68	179.2	124.5	82	212.7	112.3
69	187.3	112.3			

AQUARIUM DATA

Material: X-0341 Shot no.: C-5036

Experimenter: S. Goldstein Date: July 16, 1980

Charge diameter: 2.54 cm Charge length: 32.7 cm

Initial density: 1.908 g/cm<sup>3</sup> Temperature: 312 K

Confinement: Bare charge in water

Booster: One RP-1/PT detonator, one PBX-9407 pellet, and a 2.5-cm-diam by 2.5-cm-long PBX-9404 pellet

Exposures of image intensifier camera: Two

Time between exposures: 15.28  $\mu$ s Detonation velocity: 7.76 km/s

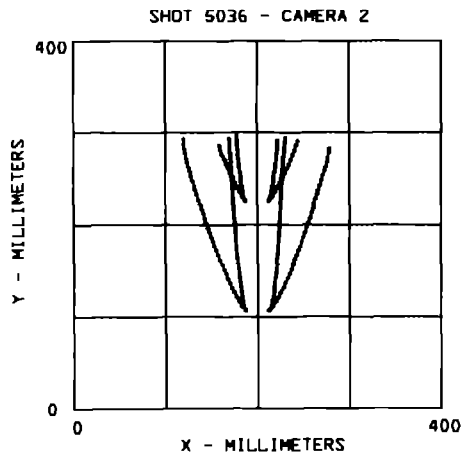
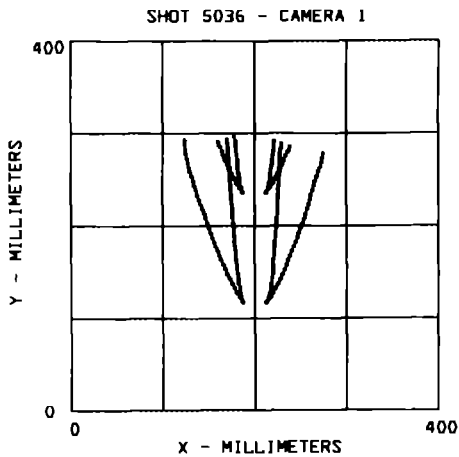

AQUARIUM DATA

SHOT 5036 - Camera 1  
EXPLOSIVE (PIPE) - WATER INTERFACE POSITIONS

Exposure 1

Left			Right		
<i>n</i>	<i>x</i> (mm)	<i>y</i> (mm)	<i>n</i>	<i>x</i> (mm)	<i>y</i> (mm)
1	178.3	295.8	14	221.5	290.7
2	179.0	290.7	15	220.9	285.7
3	179.5	285.7	16	220.4	280.7
4	179.9	280.7	17	220.0	275.7
5	180.4	275.7	18	219.6	270.7
6	181.1	270.7	19	218.9	265.6
7	181.5	265.7	20	218.2	260.6
8	182.2	260.7	21	217.5	255.6
9	182.9	255.6	22	216.7	250.6
10	183.6	250.7	23	216.1	245.6
11	184.2	245.6	24	215.3	240.6
12	185.1	240.6	25	212.7	235.6
13	187.3	235.6			

Exposure 2

Left			Right		
<i>n</i>	<i>x</i> (mm)	<i>y</i> (mm)	<i>n</i>	<i>x</i> (mm)	<i>y</i> (mm)
26	170.2	293.0	62	229.4	287.9
27	170.7	287.9	63	228.8	282.9
28	171.2	282.9	64	228.3	277.9
29	171.6	277.9	65	227.9	272.9
30	171.8	272.9	66	227.7	267.9
31	172.1	267.9	67	227.4	262.9
32	172.5	262.9	68	227.1	257.9
33	172.8	257.9	69	226.9	252.9
34	173.2	252.9	70	226.6	247.9
35	173.6	247.8	71	226.4	242.9
36	173.9	242.8	72	226.1	237.8
37	174.2	237.8	73	225.9	232.8
38	174.6	232.8	74	225.6	227.8
39	174.8	227.8	75	225.2	222.8
40	175.1	222.8	76	224.8	217.8
41	175.4	217.8	77	224.4	212.8

AQUARIUM DATA

42	175.7	212.7	78	224.1	207.7
43	176.0	207.7	79	223.5	202.8
44	176.5	202.7	80	223.2	197.7
45	177.0	197.7	81	222.9	192.7
46	177.3	192.7	82	222.6	187.7
47	177.8	187.7	83	222.3	182.7
48	178.1	182.7	84	222.0	177.7
49	178.6	177.7	85	221.6	172.7
50	179.0	172.7	86	221.1	167.6
51	179.6	167.6	87	220.6	162.6
52	180.1	162.6	88	220.0	157.6
53	180.6	157.6	89	219.7	152.6
54	180.9	152.6	90	219.0	147.6
55	180.9	152.6	91	218.5	142.6
56	182.2	142.6	92	218.0	137.6
57	182.9	137.6	93	217.2	132.6
58	183.7	132.6	94	216.5	127.5
59	184.2	127.5	95	215.6	122.5
60	185.3	122.5	96	212.7	117.5
61	187.3	117.5			

SHOCK FRONT POSITIONS

Exposure 1

Left			Right		
<i>n</i>	<i>x</i> (mm)	<i>y</i> (mm)	<i>n</i>	<i>x</i> (mm)	<i>y</i> (mm)
97	160.0	290.7	109	238.6	285.7
98	161.9	285.7	110	236.4	280.7
99	164.4	280.7	111	234.0	275.7
100	166.1	275.7	112	232.2	270.7
101	168.3	270.7	113	229.9	265.7
102	170.4	265.7	114	227.9	260.7
103	172.8	260.7	115	225.4	255.6
104	175.2	255.6	116	222.5	250.7
105	177.9	250.7	117	219.8	245.6
106	180.6	245.6	118	216.7	240.6
107	183.8	240.6	119	212.7	235.6
108	187.3	235.6			



AQUARIUM DATA

Exposure 2

Left			Right		
<i>n</i>	<i>x</i> (mm)	<i>y</i> (mm)	<i>n</i>	<i>x</i> (mm)	<i>y</i> (mm)
120	124.1	292.7	156	274.7	278.0
121	123.9	287.7	157	273.5	272.9
122	124.5	282.7	158	272.6	267.9
123	125.3	277.7	159	271.1	262.9
124	126.6	272.7	160	269.6	257.9
125	127.7	267.6	161	268.0	252.9
126	128.9	262.6	162	266.2	247.9
127	130.3	257.6	163	264.4	242.9
128	131.7	252.7	164	263.2	237.8
129	133.4	247.7	165	261.6	232.8
130	134.9	242.7	166	260.4	227.8
131	136.7	237.7	167	258.5	222.8
132	138.3	232.6	168	256.9	217.8
133	139.9	227.6	169	255.3	212.8
134	141.6	222.7	170	253.8	207.8
135	143.2	217.6	171	252.0	202.8
136	145.0	212.6	172	250.0	197.7
137	146.7	207.7	173	248.3	192.7
138	148.5	202.7	174	246.5	187.7
139	150.2	197.7	175	244.4	182.7
140	152.1	192.6	176	242.6	177.7
141	154.3	187.6	177	240.7	172.7
142	156.0	182.6	178	238.9	167.6
143	157.9	177.6	179	236.9	162.6
144	159.8	172.6	180	234.7	157.6
145	161.7	167.6	181	232.4	152.6
146	163.8	162.6	182	230.3	147.6
147	166.0	157.5	183	227.9	142.6
148	168.1	152.5	184	225.4	137.6
149	170.2	147.5	185	222.6	132.6
150	172.9	142.5	186	220.2	127.5
151	175.1	137.5	187	217.0	122.5
152	177.8	132.5	188	212.7	117.5
153	180.6	127.5			
154	183.7	122.5			
155	187.3	117.5			

SHOT 5036 - Camera 2  
EXPLOSIVE (PIPE) - WATER INTERFACE POSITIONS

Exposure 1

Left			Right		
<i>n</i>	<i>x</i> (mm)	<i>y</i> (mm)	<i>n</i>	<i>x</i> (mm)	<i>y</i> (mm)
1	177.4	295.8	16	222.2	290.8
2	177.7	290.8	17	221.7	285.8
3	178.1	285.7	18	221.3	280.7
4	178.5	280.7	19	220.9	275.7
5	178.9	275.6	20	220.4	270.7
6	179.5	270.6	21	219.8	265.6
7	179.9	265.6	22	219.1	260.6
8	180.5	260.5	23	218.6	255.5
9	181.0	255.5	24	218.0	250.5
10	181.7	250.5	25	217.6	245.5
11	182.4	245.5	26	216.8	240.4
12	183.1	240.4	27	215.9	235.4
13	183.8	235.4	28	214.8	230.3
14	184.9	230.3	29	212.7	225.3
15	187.3	225.3			

Exposure 2

Left			Right		
<i>n</i>	<i>x</i> (mm)	<i>y</i> (mm)	<i>n</i>	<i>x</i> (mm)	<i>y</i> (mm)
30	169.3	292.5	68	230.6	293.1
31	169.7	287.4	69	229.8	288.1
32	170.1	282.4	70	229.4	283.0
33	170.4	277.4	71	229.0	278.0
34	170.7	272.4	72	228.6	272.9
35	171.0	267.3	73	228.3	267.9
36	171.3	262.3	74	228.0	262.9
37	171.7	257.2	75	227.6	257.8
38	172.0	252.2	76	227.3	252.7
39	172.4	247.2	77	227.0	247.7
40	172.7	242.2	78	226.7	242.7
41	173.1	237.1	79	226.5	237.6
42	173.4	232.1	80	226.1	232.6
43	173.7	227.0	81	225.7	227.5
44	174.0	222.0	82	225.4	222.5

AQUARIUM DATA

45	174.3	217.0	83	225.2	217.4
46	174.6	212.0	84	224.9	212.4
47	174.9	207.0	85	224.6	207.3
48	175.3	201.9	86	224.3	202.3
49	175.7	196.9	87	224.0	197.2
50	176.2	191.9	88	223.6	192.2
51	176.5	186.9	89	223.2	187.1
52	176.8	181.8	90	223.0	182.1
53	177.2	176.8	91	222.7	177.0
54	177.6	171.8	92	222.4	172.0
55	178.1	166.8	93	221.8	167.0
56	178.6	161.7	94	221.4	161.9
57	179.2	156.7	95	221.0	156.9
58	179.5	151.7	96	220.4	151.8
59	179.8	146.6	97	219.9	146.8
60	180.7	141.6	98	219.4	141.7
61	181.2	136.6	99	218.8	136.7
62	182.0	131.5	100	218.3	131.6
63	182.6	126.5	101	217.8	126.6
64	183.2	121.5	102	217.0	121.5
65	183.8	116.5	103	216.2	116.5
66	184.8	111.4	104	215.0	111.4
67	187.3	106.4	105	212.7	106.4

SHOCK FRONT POSITIONS

Exposure 1

<u>Left</u>			<u>Right</u>		
<u>n</u>	<u>x (mm)</u>	<u>y (mm)</u>	<u>n</u>	<u>x (mm)</u>	<u>y (mm)</u>
106	158.6	285.7	119	244.1	290.7
107	160.3	280.6	120	242.3	285.7
108	162.3	275.6	121	240.6	280.7
109	164.9	270.5	122	238.6	275.7
110	166.7	265.5	123	236.6	270.6
111	168.4	260.5	124	234.4	265.6
112	170.5	255.5	125	232.5	260.6
113	173.2	250.4	126	229.9	255.5
114	175.6	245.4	127	227.4	250.5
115	178.2	240.4	128	225.1	245.5

AQUARIUM DATA

116	181.3	235.4	129	222.5	240.4
117	184.1	230.3	130	219.6	235.4
118	187.3	225.3	131	216.7	230.3
			132	212.7	225.3

Exposure 2

Left			Right		
<i>n</i>	x (mm)	y (mm)	<i>n</i>	x (mm)	y (mm)
133	120.0	292.4	171	278.5	283.0
134	120.0	287.4	172	277.9	278.0
135	120.7	282.3	173	276.6	272.9
136	122.0	277.3	174	275.7	267.9
137	122.9	272.3	175	274.8	262.9
138	124.1	267.3	176	273.4	257.8
139	125.3	262.2	177	271.6	252.7
140	126.8	257.2	178	270.1	247.7
141	127.8	252.1	179	268.5	242.7
142	129.3	247.1	180	266.8	237.6
143	131.0	242.1	181	265.3	232.6
144	132.7	237.1	182	263.5	227.6
145	134.5	232.0	183	262.3	222.5
146	136.3	227.0	184	260.4	217.4
147	137.9	222.0	185	258.7	212.4
148	139.6	217.0	186	257.0	207.3
149	141.0	211.9	187	255.5	202.3
150	142.6	206.9	188	253.6	197.2
151	144.3	201.8	189	251.8	192.2
152	146.0	196.8	190	250.1	187.1
153	147.9	191.8	191	247.8	182.1
154	149.9	186.8	192	246.5	177.0
155	151.9	181.7	193	244.7	172.0
156	153.6	176.7	194	242.8	167.0
157	155.5	171.7	195	240.7	161.9
158	157.4	166.7	196	238.7	156.9
159	159.2	161.6	197	237.0	151.8
160	161.4	156.6	198	234.8	146.8
161	163.4	151.6	199	232.4	141.7
162	165.8	146.6	200	230.1	136.7
163	167.6	141.6	201	227.7	131.6
164	169.9	136.5	202	225.2	126.6

## AQUARIUM DATA

165	172.0	131.5	203	222.6	121.5
166	174.6	126.5	204	220.0	116.5
167	177.4	121.5	205	216.9	111.4
168	180.2	116.5	206	212.7	106.4
169	182.7	111.4			
170	187.3	106.4			

# **PART III**

## **DETONATION VELOCITY DATA**

The detonation velocity was the first basic performance parameter studied at the Los Alamos National Laboratory. High-quality electrical switch or pin measurements were possible by the late 1940s and most of the data presented in this section were generated 20 to 30 years ago. A standard rate stick is a right cylinder, usually composed of a number of shorter cylinders that have been cast, pressed, or machined to a predetermined diameter. The stick is detonated at one end, and the progress of the detonation is measured at discrete points along the stick length. The times at which the detonation front reaches these points are determined by using the high conductivity or pressure at the detonation front to close the electrical switch or pin. The detonation velocity can be calculated from the measured distances and times.

Initially, when a rate stick is detonated, there are velocity transients for some distance along its length that are poorly understood. The data from the first part of the run are usually discarded, and the average velocity for the remainder of the run is given as the detonation velocity of the explosive for the geometry studied.

The progress in detonation theory in recent years has enabled us to study the velocity transients and to learn more about detonation physics and chemistry from such data. We have collected the velocity data for many explosive systems studied at Los Alamos and presented it as completely as possible and without any interpretation. This data collection should be of value to scientists attempting to advance the state of detonation science to include the time-dependent effects represented by the velocity transients in the data.

DETONATION VELOCITY DATA

**Data List**

Ammonium perchlorate, $\rho = 1.32 \text{ g/cm}^3$	260
Comp A, $\rho = 1.00\text{-}1.60 \text{ g/cm}^3$	261
Comp A-3, $\rho = 1.10\text{-}1.64 \text{ g/cm}^3$	269
Comp B, $\rho = 1.20\text{-}1.71 \text{ g/cm}^3$	279
Comp B/titanium hydride, $\rho = 1.98 \text{ g/cm}^3$	284
Comp B/zirconium hydride, $\rho = 2.12\text{-}2.23 \text{ g/cm}^3$	286
Comp B-3, $\rho = 1.71 \text{ g/cm}^3$	287
Cyclotol, $\rho = 1.20\text{-}1.73 \text{ g/cm}^3$	290
DATB, $\rho = 1.20\text{-}1.79 \text{ g/cm}^3$	295
HMX/DNPA/DNPM, $\rho = 1.81 \text{ g/cm}^3$	300
HMX/Exon, $\rho = 1.83\text{-}1.86 \text{ g/cm}^3$	302
HMX/Kel-F, $\rho = 1.86\text{-}1.87 \text{ g/cm}^3$	305
HMX/Kel-F/tungsten, $\rho = 3.53 \text{ g/cm}^3$	310
HMX/methyl dekene, $\rho = 1.66 \text{ g/cm}^3$	311
HMX/PS/DOP, $\rho = 1.65 \text{ g/cm}^3$	313
Octol, $\rho = 1.20 \text{ g/cm}^3$	317
PBX 9205, $\rho = 1.60\text{-}1.69 \text{ g/cm}^3$	321
Potassium dinitroacetone, $\rho = 1.91 \text{ g/cm}^3$	347
RDX, $\rho = 0.90\text{-}1.77 \text{ g/cm}^3$	348
RDX/ammonium perchlorate, $\rho = 1.88\text{-}1.95 \text{ g/cm}^3$	436
RDX/barium chromate, $\rho = 2.83 \text{ g/cm}^3$	438
RDX/boric acid/PS/DOP, $\rho = 1.40 \text{ g/cm}^3$	439
RDX/boric oxide, $\rho = 1.32\text{-}1.66 \text{ g/cm}^3$	440
RDX/carbon, $\rho = 1.45\text{-}1.59 \text{ g/cm}^3$	446
RDX/copper, $\rho = 1.78\text{-}2.49 \text{ g/cm}^3$	448
RDX/DNPA, $\rho = 1.62\text{-}1.75 \text{ g/cm}^3$	466
RDX/DNPA/DIOA, $\rho = 1.72 \text{ g/cm}^3$	489
RDX/Exon, $\rho = 1.77\text{-}1.79 \text{ g/cm}^3$	491
RDX/Exon/lead, $\rho = 2.70\text{-}4.60 \text{ g/cm}^3$	504
RDX/Kel-F, $\rho = 1.64\text{-}1.85 \text{ g/cm}^3$	510
RDX/Kel-F/lead, $\rho = 2.74 \text{ g/cm}^3$	526
RDX/basic lead sulfate/plastic, $\rho = 3.43 \text{ g/cm}^3$	527
RDX/Neoprene, $\rho = 1.75 \text{ g/cm}^3$	528
RDX/NC/TOF, $\rho = 1.70\text{-}1.72 \text{ g/cm}^3$	529
RDX/Paracril/PS, $\rho = 1.70 \text{ g/cm}^3$	533
RDX/PS/DOP, $\rho = 1.00\text{-}1.69 \text{ g/cm}^3$	534
RDX/DOP/PS/carbon, $\rho = 1.60\text{-}1.61 \text{ g/cm}^3$	566
RDX/PS/DOP/resin, $\rho = 1.67\text{-}1.68 \text{ g/cm}^3$	568
RDX/potassium chloride, $\rho = 1.67 \text{ g/cm}^3$	571
RDX/Saran, $\rho = 1.78 \text{ g/cm}^3$	574

## DETONATION VELOCITY DATA

RDX/Silastic, $\rho = 1.80\text{-}1.81 \text{ g/cm}^3$ . . . . .	576
RDX/Teflon, $\rho = 1.83 \text{ g/cm}^3$ . . . . .	580
RDX/Teflon/rubber, $\rho = 1.67 \text{ g/cm}^3$ . . . . .	582
RDX/TNT, $\rho = 1.20\text{-}1.75 \text{ g/cm}^3$ . . . . .	583
RDX/zirconium hydride, $\rho = 2.19 \text{ g/cm}^3$ . . . . .	612
RDX/zirconium hydride/PS/DOP, $\rho = 2.09\text{-}2.15 \text{ g/cm}^3$ . . . . .	612
TATB, $\rho = 1.86\text{-}1.87 \text{ g/cm}^3$ . . . . .	614
Tetryl, $\rho = 1.69 \text{ g/cm}^3$ . . . . .	618
TNT, $\rho = 0.90\text{-}1.64 \text{ g/cm}^3$ . . . . .	625
TNT/DNT, $\rho = 1.30\text{-}1.50 \text{ g/cm}^3$ . . . . .	736
TNT/PETN/tetryl, $\rho = 1.64\text{-}1.66 \text{ g/cm}^3$ . . . . .	745
TNT/RDX, $\rho = 1.20\text{-}1.66 \text{ g/cm}^3$ . . . . .	747
TNT/RDX/ammonium perchlorate, $\rho = 1.68\text{-}1.73 \text{ g/cm}^3$ . . . . .	774
TNTAB, $\rho = 0.80\text{-}1.76 \text{ g/cm}^3$ . . . . .	788
Tritonal, TNT/aluminum, $\rho = 1.41\text{-}1.44 \text{ g/cm}^3$ . . . . .	803



**DETONATION VELOCITY DATA**

**Material:** Ammonium perchlorate

**Experimenter:** J. B. Panowski    **Date:** June 8, 1955

**Shot no.:** GMX-2-743; GMX-8-B-3655

**Diameter:** 3 in.    **Average density:** 1.318 g/cm<sup>3</sup>    **Voids:** 33.15%

**Booster:** 1E15 detonator and 1-in.-long Comp B

<u>Increment no.</u>	<u>Length (in.)</u>	<u>Density (g/cm<sup>3</sup>)</u>	<u>Velocity (m/s)</u>
1	1.982	1.320	---
2	1.983	1.320	---
3	1.983	1.319	---
4	1.984	1.319	3736
5	1.986	1.316	3737
6	1.986	1.316	3627
7	1.986	1.316	3667
8	1.986	1.315	3660
9	1.986	1.312	3663
10	1.984	1.318	3670
11	1.983	1.320	3672
12	1.984	1.317	3633
13	1.986	1.317	3665
14	1.986	1.317	3694
15	1.986	1.322	3695

**Average velocity of increments 4-15:** 3677 m/s

DETONATION VELOCITY DATA

**Material:** Comp A, 90 wt% jar-milled RDX/9.8 wt% Stanolind 170/175 wax/  
0.2 wt% AloX 600

**Experimenter:** F. DuBois    **Date:** May 26, 1953

**Shot no.:** GMX-2-13398; GMX-8-B-2457

**Diameter:** 1 in.    **Average density:** 0.998 g/cm<sup>3</sup>

**Fabrication:** Slurry, pressed

**Booster:** 1E15 detonator and Comp B

<u>Increment no.</u>	<u>Length (in.)</u>	<u>Density (g/cm<sup>3</sup>)</u>	<u>Velocity (m/s)</u>
1	2.000 ± 0.0003	0.998	---
2	2.000 ± 0.0003	0.998	5699
3	2.000 ± 0.0003	1.000	5691
4	2.000 ± 0.0003	0.997	5690

**Average velocity of increments 2-4:** 5693 m/s

**DETONATION VELOCITY DATA**

**Material:** Comp A, 90 wt% jar-milled RDX/9.8 wt% Stanolind 170/175 wax/  
0.2 wt% Alox 600

**Experimenter:** F. DuBois      **Date:** May 26, 1953

**Shot no.:** GMX-2-13397; GMX-8-B-2456

**Diameter:** 1 in.      **Average density:** 1.000 g/cm<sup>3</sup>

**Fabrication:** Slurry, pressed

**Booster:** 1E15 detonator and Comp B

<u>Increment no.</u>	<u>Length (in.)</u>	<u>Density (g/cm<sup>3</sup>)</u>	<u>Velocity (m/s)</u>
1	2.000 ± 0.0003	0.999	---
2	2.000 ± 0.0003	1.000	5715
3	2.000 ± 0.0003	1.000	5705
4	2.000 ± 0.0003	1.0002	5693

**Average velocity of increments 2-4:** 5704 m/s

DETONATION VELOCITY DATA

**Material:** Comp A, 90 wt% jar-milled RDX/9.8 wt% Stanolind 170/175 wax/  
0.2 wt% Alox 600

**Experimenter:** F. DuBois      **Date:** July 7, 1953

**Shot no.:** GMX-2-13409; GMX-8-B-2569

**Diameter:** 1 in.      **Average density:** 1.304 g/cm<sup>3</sup>

**Fabrication:** Slurry, pressed

**Booster:** 1E15 detonator and Comp B

<u>Increment no.</u>	<u>Length (in.)</u>	<u>Density (g/cm<sup>3</sup>)</u>	<u>Velocity (m/s)</u>
1	---	---	---
2	2.0101	1.303	6802
3	2.0090	1.304	6818
4	2.0082	1.304	6824

**Average velocity of increments 2-4:** 6815 m/s

**DETONATION VELOCITY DATA**

**Material:** Comp A, 90 wt% jar-milled RDX/9.8 wt% Stanolind 170/175 wax/  
0.2 wt% Alox 600

**Experimenter:** F. DuBois      **Date:** July 15, 1953

**Shot no.:** GMX-2-13418; GMX-8-B-2588

**Diameter:** 1 in.      **Average density:** 1.304 g/cm<sup>3</sup>

**Fabrication:** Slurry, pressed

**Booster:** 1E15 detonator and Comp B

<u>Increment no.</u>	<u>Length (in.)</u>	<u>Density (g/cm<sup>3</sup>)</u>	<u>Velocity (m/s)</u>
1	---	---	---
2	---	---	---
3	2.0083	1.304	6810
4	2.0098	1.303	6834
5	2.0093	1.304	6826

**Average velocity of increments 3-5:** 6823 m/s

## DETONATION VELOCITY DATA

**Material:** Comp A, 90.9 wt% jar-milled RDX/9.8 wt% Stanolind 170/175 wax/  
0.2 wt% Alox 600

**Experimenter:** F. DuBois      **Date:** July 7, 1953

**Shot no.:** GMX-2-13410; GMX-8-B-2568

**Diameter:** 1 in.      **Average density:** 1.450 g/cm<sup>3</sup>

**Fabrication:** Slurry, pressed

**Booster:** 1E15 detonator and Comp B

<u>Increment no.</u>	<u>Length (in.)</u>	<u>Density (g/cm<sup>3</sup>)</u>	<u>Velocity (m/s)</u>
1	---	---	---
2	2.0125	1.450	7349
3	2.0126	1.450	7368
4	2.0127	1.450	7363

**Average velocity of increments 2-4:** 7360 m/s

**DETONATION VELOCITY DATA**

**Material:** Comp A, 90 wt% jar-milled RDX/9.8 wt% Stanolind 170/175 wax/  
0.2 wt% Alox 600

**Experimenter:** F. DuBois      **Date:** July 15, 1953

**Shot no.:** GMX-2-13416; GMX-8-B-2587

**Diameter:** 1 in.      **Average density:** 1.450 g/cm<sup>3</sup>

**Fabrication:** Slurry, pressed

**Booster:** 1E15 detonator and Comp B

<u>Increment no.</u>	<u>Length (in.)</u>	<u>Density (g/cm<sup>3</sup>)</u>	<u>Velocity (m/s)</u>
1	---	---	---
2	---	---	---
3	2.0125	1.450	7372
4	2.0126	1.450	7377
5	2.0127	1.450	7406

**Average velocity of increments 3-5:** 7385 m/s

DETONATION VELOCITY DATA

**Material:** Comp A, 90 wt% jar-milled RDX/9.8 wt% Stanolind 170/175 wax/  
0.2 wt% Alox 600

**Experimenter:** F. DuBois      **Date:** June 1, 1953

**Shot no.:** GMX-2-13400; GMX-8-B-2507

**Diameter:** 1 in.      **Average density:** 1.595 g/cm<sup>3</sup>      **Voids:** 4.09%

**Fabrication:** Slurry, pressed

**Booster:** 1E15 detonator and Comp B

<u>Increment no.</u>	<u>Length (in.)</u>	<u>Density (g/cm<sup>3</sup>)</u>	<u>Velocity (m/s)</u>
1	2.0165	1.595	---
2	2.0159	1.595	8073
3	2.0162	1.595	8064
4	2.0164	1.595	8080

**Average velocity of increments 2-4:** 8072 m/s



**DETONATION VELOCITY DATA**

**Material:** Comp A, 90 wt% jar-milled RDX/9.8 wt% Stanolind 170/175 wax/  
0.2 wt% Alox 600

**Experimenter:** F. DuBois     **Date:** June 1, 1953

**Shot no.:** GMX-2-13399; GMX-8-B-2506

**Diameter:** 1 in.     **Average density:** 1.595 g/cm<sup>3</sup>     **Voids:** 4.09%

**Fabrication:** Slurry, pressed

**Booster:** 1E15 detonator and Comp B

<u>Increment no.</u>	<u>Length (in.)</u>	<u>Density (g/cm<sup>3</sup>)</u>	<u>Velocity (m/s)</u>
1	2.0157	1.595	--
2	2.0166	1.595	8066
3	2.0162	1.595	8076
4	2.0164	1.595	8078

**Average velocity of increments 2-4:** 8073 m/s

DETONATION VELOCITY DATA

**Material:** Comp A-3, 91 wt% RDX/9 wt% wax

**Experimenter:** K. Fess      **Date:** October 1, 1952

**Shot no.:** GMX-2-11566; GMX-8-FL-6361

**Diameter:** 2 in.      **Average density:** 1.1003 g/cm<sup>3</sup>

**Fabrication:** Micro-milled

**Booster:** 1E15 detonator and P-040 lens

<u>Increment no.</u>	<u>Length (in.)</u>	<u>Density (g/cm<sup>3</sup>)</u>	<u>Velocity (m/s)</u>
1	1.049	1.102	---
2	1.049	1.101	--
3	1.050	1.100	---
4	1.0505	1.100	---
5	1.0505	1.100	---
6	1.0505	1.100	6188
7	1.0505	1.100	--
8	1.0505	1.100	6328
9	1.0505	1.100	--
10	1.0505	1.100	6106

**Average velocity of increments 5-10:** 6207 m/s

DETONATION VELOCITY DATA

**Material:** Comp A-3, 91 wt% RDX/9 wt% wax

**Experimenter:** K. Fess     **Date:** October 1, 1952

**Shot no.:** GMX-2-11768; GMX-8-FL-6362

**Diameter:** 2 in.     **Average density:** 1.1098 g/cm<sup>3</sup>

**Fabrication:** Micro-milled

**Booster:** 1E15 detonator and P-040 lens

<u>Increment no.</u>	<u>Length (in.)</u>	<u>Density (g/cm<sup>3</sup>)</u>	<u>Velocity (m/s)</u>
1	1.0515	1.099	---
2	1.0515	1.099	---
3	1.051	1.099	---
4	1.0515	1.098	---
5	1.049	1.097	---
6	1.051	1.099	6462
7	1.051	1.098	---
8	1.051	1.098	6103
9	1.0505	1.098	---
10	1.0505	1.098	6148

**Average velocity of increments 5-10:** 6238 m/s

DETONATION VELOCITY DATA

Material: Comp A-3, 91 wt% RDX/9 wt% wax

Experimenter: K. Fess Date: October 1, 1952

Shot no.: GMX-2-11540; GMX-8-FL-6364

Diameter: 2 in. Average density: 1.301 g/cm<sup>3</sup>

Booster: 1E15 detonator and P-040 lens

<u>Increment no.</u>	<u>Length (in.)</u>	<u>Density (g/cm<sup>3</sup>)</u>	<u>Velocity (m/s)</u>
1	1.0515	1.300	--
2	1.0515	1.300	---
3	1.052	1.300	--
4	1.052	1.300	---
5	1.0515	1.301	---
6	1.0515	1.301	6825
7	1.051	1.301	---
8	1.0515	1.301	7228
9	1.0515	1.301	--
10	1.051	1.301	6675

Average velocity of increments 5-10: 6909 m/s

**DETONATION VELOCITY DATA**

**Material:** Comp A-3, 91 wt% RDX/9 wt% wax

**Experimenter:** K. Fess     **Date:** October 2, 1952

**Shot no.:** GMX-2-11553; GMX-8-FL-6363

**Diameter:** 2 in.     **Average density:** 1.302 g/cm<sup>3</sup>

**Booster:** 1E15 detonator and P-040 lens

<b>Increment no.</b>	<b>Length (in.)</b>	<b>Density (g/cm<sup>3</sup>)</b>	<b>Velocity (m/s)</b>
1	1.050	1.303	---
2	1.0515	1.301	---
3	1.0515	1.301	---
4	1.0515	1.301	---
5	1.051	1.302	---
6	1.051	1.302	6451
7	1.0515	1.302	---
8	1.051	1.302	7276
9	1.050	1.302	---
10	1.051	1.302	6566

**Average velocity of increments 5-10:** 6764 m/s

## DETONATION VELOCITY DATA

**Material:** Comp A-3, 91 wt% RDX/9 wt% wax

**Experimenter:** J. B. Panowski      **Date:** September 9, 1952

**Shot no.:** GMX-2-48092341; GMX-8-FL-6289

**Diameter:** 2 in.      **Average density:** 1.408 g/cm<sup>3</sup>

**Booster:** P-040 lens

<u>Increment no.</u>	<u>Length (in.)</u>	<u>Density (g/cm<sup>3</sup>)</u>
1	1.054	1.4069
2	1.054	1.4087
3	1.0535	1.4096
4	1.054	1.4089
5	1.0535	1.4093
6	1.0535	1.4096
7	1.054	1.4075
8	1.054	1.4075
9	1.054	1.4074
10	1.054	1.4078

**Average velocity of increments 7-10:** 7490 m/s

DETONATION VELOCITY DATA

**Material:** Comp A-3, 91 wt% RDX/9 wt% wax

**Experimenter:** J. B. Panowski      **Date:** September 9, 1952

**Shot no.:** GMX-2-48092651; GMX-8-FL-6294

**Diameter:** 2 in.      **Average density:** 1.4085 g/cm<sup>3</sup>

**Booster:** P-040 lens

<u>Increment no.</u>	<u>Length (in.)</u>	<u>Density (g/cm<sup>3</sup>)</u>
1	1.054	1.4094
2	1.054	1.4091
3	1.054	1.4090
4	1.054	1.4089
5	1.0535	1.4096
6	1.054	1.4090
7	1.054	1.4073
8	1.054	1.4076
9	1.054	1.4075
10	1.054	1.4076

**Average velocity of increments 7-10:** 7505 m/s

DETONATION VELOCITY DATA

**Material:** Comp A-3, 91 wt% RDX/9 wt% wax

**Experimenter:** J. B. Panowski      **Date:** September 9, 1952

**Shot no.:** GMX-2-48167102; GMX-8-FL-6293

**Diameter:** 2 in.      **Average density:** 1.5008 g/cm<sup>3</sup>

**Booster:** P-040 lens

<u>Increment no.</u>	<u>Length (in.)</u>	<u>Density (g/cm<sup>3</sup>)</u>
1	1.057	1.5006
2	1.057	1.5002
3	1.057	1.5006
4	1.057	1.5002
5	1.057	1.5005
6	1.057	1.5006
7	1.057	1.5012
8	1.057	1.5013
9	1.057	1.5012
10	1.057	1.5012

**Average velocity of increments 7-10:** 7765 m/s



**DETONATION VELOCITY DATA**

**Material:** Comp A-3, 91 wt% RDX/9 wt% wax

**Experimenter:** J. B. Panowski      **Date:** September 9, 1952

**Shot no.:** GMX-2-48092311; GMX-8-FL-6292

**Diameter:** 2 in.      **Average density:** 1.501 g/cm<sup>3</sup>

**Booster:** P-040 lens

<u>Increment no.</u>	<u>Length (in.)</u>	<u>Density (g/cm<sup>3</sup>)</u>
1	1.057	1.5014
2	1.057	1.5012
3	1.057	1.5012
4	1.057	1.5010
5	1.057	1.5012
6	1.057	1.5013
7	1.0575	1.5004
8	1.0575	1.5004
9	1.057	1.5004
10	1.057	1.5005

**Average velocity of increments 7-10:** 7794 m/s

DETONATION VELOCITY DATA

**Material:** Comp A-3, 91 wt% RDX/9 wt% wax

**Experimenter:** J. B. Panowski      **Date:** September 9, 1952

**Shot no.:** GMX-2-48419312; GMX-8-FL-6290

**Diameter:** 2 in.      **Average density:** 1.598 g/cm<sup>3</sup>

**Booster:** P-040 lens

<u>Increment no.</u>	<u>Length (in.)</u>	<u>Density (g/cm<sup>3</sup>)</u>
1	1.000	1.5994
2	1.000	1.5969
3	1.000	1.5989
4	1.000	1.5978
5	1.000	1.5953
6	1.000	1.5957
7	1.000	1.6028
8	1.000	1.6028
9	1.000	1.6038
10	0.9995	1.6034

**Average velocity of increments 7-10:** 8837 m/s

**DETONATION VELOCITY DATA**

**Material:** Comp A-3, 91 wt% RDX/9 wt% wax

**Experimenter:** F. DuBois      **Date:** December 9, 1953

**Shot no.:** GMX-2-104; GMX-8-B-2927

**Diameter:** 1.636 in.      **Average density:** 1.635 g/cm<sup>3</sup>      **Voids:** 1.8%

**Fabrication:** Slurry, vacuum pressed

**Booster:** 1E15 detonator

<u>Increment no.</u>	<u>Length (in.)</u>	<u>Density (g/cm<sup>3</sup>)</u>	<u>Velocity (m/s)</u>
1	3.250	1.636	--
2	3.250	1.635	8278
3	3.250	1.636	8279
4	3.250	1.634	8286
5	3.250	1.636	8291
6	3.250	1.636	8298

**Average velocity of increments 2-6:** 8286 m/s

DETONATION VELOCITY DATA

Material: Special Comp B, 66.2 wt% RDX/32.8 wt% TNT/1.0 wt% wax

Experimenter: M. J. Urizar Date: January 14, 1954

Shot no.: GMX-2-127; GMX-8-D-4343

Diameter: 2 in. Average density: 1.200 g/cm<sup>3</sup> Voids: 30%

Fabrication: Ground; pressed into brass Confinement: 0.5-in. wall brass

Booster: 1E15 detonator and Comp B

<u>Increment no.</u>	<u>Length (in.)</u>	<u>Density (g/cm<sup>3</sup>)</u>	<u>Velocity (m/s)</u>
1	2.000	1.204	---
2	2.000	1.199	---
3	2.000	1.200	6335
4	2.000	1.200	6292
5	2.000	1.200	6346
6	2.000	1.200	6373
7	2.000	1.200	6319
8	2.000	1.200	6338

Average velocity of increments 3-8: 6334 m/s

**DETONATION VELOCITY DATA**

**Material:** Special Comp B, 66.2 wt% RDX/32.8 wt% TNT/1.0 wt% wax

**Experimenter:** M. J. Urizar      **Date:** January 14, 1954

**Shot no.:** GMX-2-128; GMX-8-D-4346

**Diameter:** 2 in.      **Average density:** 1.200 g/cm<sup>3</sup>      **Voids:** 30%

**Fabrication:** Ground; pressed into brass      **Confinement:** 0.5-in. wall brass

**Booster:** 1E15 detonator and Comp B

<u>Increment no.</u>	<u>Length (in.)</u>	<u>Density (g/cm<sup>3</sup>)</u>	<u>Velocity (m/s)</u>
1	2.000	1.200	---
2	2.000	1.200	---
3	2.000	1.200	6336
4	2.000	1.200	6342
5	2.000	1.200	6340
6	2.000	1.200	6327
7	2.000	1.201	6359
8	2.000	1.200	6357

**Average velocity of increments 3-8:** 6344 m/s

DETONATION VELOCITY DATA

**Material:** Special Comp B, 66.2 wt% RDX/32.8 wt% TNT/1.0 wt% wax

**Experimenter:** M. J. Urizar      **Date:** January 13, 1954

**Shot no.:** GMX-2-136; GMX-8-D-4339

**Diameter:** 4 in.      **Average density:** 1.200 g/cm<sup>3</sup>      **Voids:** 30%

**Fabrication:** Ground; pressed into brass      **Confinement:** 1-in. wall brass

**Booster:** 1E15 detonator and Comp B

<u>Increment no.</u>	<u>Length (in.)</u>	<u>Density (g/cm<sup>3</sup>)</u>	<u>Velocity (m/s)</u>
1	4.000	1.200	---
2	4.000	1.200	---
3	4.000	1.200	6409
4	4.000	1.200	6370
5	4.000	1.200	6358
6	4.000	1.200	6376
7	4.000	1.200	6396
8	4.000	1.200	6425

**Average velocity of increments 3-8:** 6389 m/s

**DETONATION VELOCITY DATA**

**Material:** Special Comp B, 66.2 wt% RDX/32.8 wt% TNT/1.0 wt% wax

**Experimenter:** M. J. Urizar      **Date:** January 13, 1954

**Shot no.:** GMX-2-135; GMX-8-D-4340

**Diameter:** 4 in.      **Average density:** 1.200 g/cm<sup>3</sup>      **Voids:** 30%

**Fabrication:** Ground; pressed into brass      **Confinement:** 1-in. wall brass

**Booster:** 1E15 detonator and Comp B

<u>Increment no.</u>	<u>Length (in.)</u>	<u>Density (g/cm<sup>3</sup>)</u>	<u>Velocity (m/s)</u>
1	4.000	1.200	---
2	4.000	1.200	---
3	4.000	1.200	6396
4	4.000	1.200	6381
5	4.000	1.200	6382
6	4.000	1.200	6403
7	4.000	1.200	6360
8	4.000	1.200	6418

**Average velocity of increments 3-8:** 6390 m/s

DETONATION VELOCITY DATA

**Material:** Comp B, 64 wt% RDX/35 wt% TNT/1 wt% wax

**Experimenter:** F. DuBois      **Date:** October 27, 1953

**Shot no.:** GMX-2-76-C; GMX-8-B-2830

**Diameter:** 1 in.      **Average density:** 1.706 g/cm<sup>3</sup>

**Booster:** 1E15 detonator

<u>Increment no.</u>	<u>Length (in.)</u>	<u>Density (g/cm<sup>3</sup>)</u>	<u>Velocity (m/s)</u>
1	2	1.706	---
2	2	1.706	7882
3	2	1.706	7912

**Average velocity of increments 2 and 3:** 7897 m/s



**DETONATION VELOCITY DATA**

**Material:** 75 wt% Comp B/25 wt% titanium hydride

**Experimenters:** F. DuBois and K. Fess    **Date:** August 11, 1951

**Shot no.:** GMX-2-0862; GMX-8-FL-4823

**Diameter:** 1.622 in.    **Average density:** 1.9778 g/cm<sup>3</sup>

**Booster:** 1E15 detonator, P-040 lens, and 1-in.-long Comp B

**Average velocity of increments:** 7476 m/s

**Material:** 75 wt% Comp B/25 wt% titanium hydride

**Experimenters:** F. DuBois and K. Fess    **Date:** August 11, 1951

**Shot no.:** GMX-2-0836; GMX-8-D-2528

**Diameter:** 1.995 in.    **Average density:** 1.9805 g/cm<sup>3</sup>

**Booster:** 1E15 detonator, P-040 lens, and 1-in.-long Comp B

**Average velocity of increments:** 7436 m/s

DETONATION VELOCITY DATA

**Material:** 75 wt% Comp B/25 wt% titanium hydride

**Experimenters:** F. DuBois and K. Fess      **Date:** August 11, 1951

**Shot no.:** GMX-2-0837; GMX-8-FL-4823

**Diameter:** 1.727 in.      **Average density:** 1.9807 g/cm<sup>3</sup>

**Booster:** 1E15 detonator, P-040 lens, and 1-in.-long Comp B

**Average velocity of increments:** 7429 m/s

**Material:** 75 wt% Comp B/25 wt% titanium hydride

**Experimenters:** F. DuBois and K. Fess      **Date:** August 11, 1951

**Shot no.:** GMX-2-0862B; GMX-8-D-2528

**Diameter:** 1.726 in.      **Average density:** 1.9808 g/cm<sup>3</sup>

**Booster:** 1E15 detonator, P-040 lens, and 1-in.-long Comp B

**Average velocity of increments:** 7418 m/s

DETONATION VELOCITY DATA

**Material:** 70 wt% Comp B/30 wt% zirconium hydride

**Experimenters:** F. DuBois and K. Fess    **Date:** August 11, 1951

**Shot no.:** GMX-2-0827T; GMX-8-D-2531

**Diameter:** 1.695 in.    **Average density:** 2.1215 g/cm<sup>3</sup>

**Booster:** 1E15 detonator, P-040 lens, and 1-in.-long Comp B

**Average velocity of increments:** 6937 m/s

**Material:** 70 wt% Comp B/30 wt% zirconium hydride

**Experimenters:** F. DuBois and K. Fess    **Date:** August 11, 1951

**Shot no.:** GMX-2-0826; GMX-8-D-2529

**Diameter:** 1.012 in.    **Average density:** 2.230 g/cm<sup>3</sup>

**Booster:** 1E15 detonator, P-040 lens, and 1-in.-long Comp B

**Average velocity of increments:** 7172 m/s

DETONATION VELOCITY DATA

Material: Comp B-3, 60 wt% RDX/40 wt% TNT

Experimenter: K. Fess Date: October 15, 1952

Shot no.: GMX-2-78239301-45; GMX-8-B-1713

Diameter: 2 in. Average density: 1.7066 g/cm<sup>3</sup>

Fabrication: Cast

Booster: 1E15 detonator and P-040 lens

<u>Increment no.</u>	<u>Length (in.)</u>	<u>Density (g/cm<sup>3</sup>)</u>	<u>Velocity (m/s)</u>
1	0.9805	1.7080	--
2	1.0005	1.7074	8142
3	1.0005	1.7074	7769
4	1.0005	1.7074	7981
5	1.0005	1.7077	7956
6	1.0000	1.7070	7986
7	1.0005	1.7068	7947
8	1.0005	1.7067	7963
9	1.0005	1.7063	7991
10	1.0005	1.7063	7953
11	1.0000	1.7061	7959
12	1.0005	1.7061	7966
13	1.0005	1.7059	7976
14	1.0005	1.7055	7948
15	1.0005	1.7048	7934

Average velocity of increments 2-15: 7962 m/s

DETONATION VELOCITY DATA

**Material:** Comp B-3, 60 wt% RDX/40 wt% TNT

**Experimenter:** K. Fess      **Date:** October 15, 1952

**Shot no.:** GMX-2-78239301-9; GMX-8-B-1711

**Diameter:** 3 in.      **Average density:** 1.7081 g/cm<sup>3</sup>

**Fabrication:** Cast

**Booster:** P-040 lens

<u>Increment no.</u>	<u>Length (in.)</u>	<u>Density (g/cm<sup>3</sup>)</u>	<u>Velocity (m/s)</u>
1	1.0005	1.7095	--
2	1.0000	1.7098	7937
3	1.0005	1.7091	7947
4	1.0005	1.7096	7954
5	1.0005	1.7084	7952
6	1.0005	1.7086	7944
7	1.0010	1.7084	7974
8	1.0005	1.7089	7967
9	1.0005	1.7082	7982
10	1.0005	1.7082	7962
11	1.0005	1.7072	7977
12	1.0005	1.7072	7954
13	1.0005	1.7066	7957
14	1.0005	1.7068	7962
15	1.0005	1.7050	7927

**Average velocity of increments 2-15:** 7957 m/s

DETONATION VELOCITY DATA

**Material:** Comp B-3, 60 wt% RDX/40 wt% TNT

**Experimenter:** K. Fess     **Date:** October 15, 1952

**Shot no.:** GMX-2-78239301-16; GMX-8-B-1712

**Diameter:** 2 in.     **Average density:** 1.7091 g/cm<sup>3</sup>

**Fabrication:** Cast

**Booster:** P-040 lens

<u>Increment no.</u>	<u>Length (in.)</u>	<u>Density (g/cm<sup>3</sup>)</u>	<u>Velocity (m/s)</u>
1	1.0005	1.7108	---
2	1.0005	1.7112	---
3	1.0005	1.7105	7936
4	1.0000	1.7097	7971
5	1.0005	1.7092	7978
6	1.0005	1.7094	7954
7	1.0005	1.7085	7976
8	0.9995	1.7085	7966
9	1.0005	1.7088	7976
10	1.0005	1.7085	7930
11	1.0000	1.7085	7959
12	1.0000	1.7086	7964
13	1.0005	1.7082	7957
14	1.0005	1.7078	7964
15	1.0005	1.7076	7942

**Average velocity of increments 3-15:** 7959 m/s

**DETONATION VELOCITY DATA**

**Material:** Cyclotol, 75 wt% RDX/25 wt% TNT

**Experimenter:** M. J. Urizar      **Date:** January 6, 1958

**Shot no.:** GMX-2-1074-B; GMX-8-E-0552

**Diameter:** 2.04 in.      **Average density:** 1.198 g/cm<sup>3</sup>      **Voids:** 32%

**Fabrication:** Jar milled, pressed into tubes      **Confinement:** 0.2-in. wall brass

**Booster:** P-016 lens and 0.25-in.-long Comp B

<u>Increment no.</u>	<u>Length (in.)</u>	<u>Density (g/cm<sup>3</sup>)</u>	<u>Velocity (m/s)</u>
1	3.001	1.203	6530
2	3.001	1.196	6435
3	3.001	1.196	6483
4	3.001	1.197	6478
5	3.001	1.197	6477
6	3.000	1.198	6475
7	3.000	1.198	6463
8	3.000	1.197	6484

**Average velocity of increments 1-8:** 6478 m/s

DETONATION VELOCITY DATA

**Material:** Cyclotol, 75 wt% RDX/25 wt% TNT

**Experimenter:** M. J. Urizar      **Date:** January 6, 1958

**Shot no.:** GMX-2-1074-A; GMX-8-E-0553

**Diameter:** 2.04 in.      **Average density:** 1.200 g/cm<sup>3</sup>      **Voids:** 32%

**Fabrication:** Jar milled, pressed into tubes      **Confinement:** 0.2-in. wall brass

**Booster:** P-016 lens and 0.25-in.-long Comp B

<u>Increment no.</u>	<u>Length (in.)</u>	<u>Density (g/cm<sup>3</sup>)</u>	<u>Velocity (m/s)</u>
1	3.001	1.201	6472
2	3.000	1.201	6463
3	3.000	1.199	6476
4	3.001	1.199	6481
5	3.001	1.200	6488
6	3.001	1.200	6489
7	3.001	1.198	6466
8	3.000	1.199	6475

**Average velocity of increments 1-8:** 6476 m/s



**DETONATION VELOCITY DATA**

**Material:** Cyclotol, 75 wt% RDX/25 wt% TNT

**Experimenter:** M. J. Urizar    **Date:** January 6, 1958

**Shot no.:** GMX-2-1074-C; GMX-8-E-0549

**Diameter:** 4.08 in.    **Average density:** 1.200 g/cm<sup>3</sup>    **Voids:** 32%

**Fabrication:** Jar milled, pressed into tubes    **Confinement:** 0.2-in. wall brass

**Booster:** P-022 lens and 0.25-in.-long Comp B

<u>Increment no.</u>	<u>Length (in.)</u>	<u>Density (g/cm<sup>3</sup>)</u>	<u>Velocity (m/s)</u>
1	6.002	1.201	6510
2	5.997	1.201	6489
3	6.000	1.200	6493
4	6.000	1.200	6492
5	6.001	1.200	6495
6	6.002	1.199	6483
7	6.002	1.200	6499

**Average velocity of increments 1-7:** 6494 m/s

DETONATION VELOCITY DATA

**Material:** Cyclotol, 75 wt% RDX/25 wt% TNT

**Experimenter:** E. James, Jr.    **Date:** January 8, 1951

**Shot no.:** GMX-2-10270; GMX-8-FL-3759

**Diameter:** 3 in. with 1/16 taper    **Average density:** 1.720 g/cm<sup>3</sup>

**Booster:** 1E15 detonator, P-040 lens, and 1-in.-long Comp B

<u>Increment no.</u>	<u>Length (in.)</u>	<u>Density (g/cm<sup>3</sup>)</u>	<u>Velocity (m/s)</u>
1	9.017	1.720	8176

**Material:** Cyclotol, 75 wt% RDX/25 wt% TNT

**Experimenter:** E. James, Jr.    **Date:** January 8, 1951

**Shot no.:** GMX-2-10286; GMX-8-FL-3761

**Diameter:** 1.5 in. (no taper)    **Average density:** 1.723 g/cm<sup>3</sup>

**Booster:** 1E15 detonator, P-015 lens, and 1-in.-long Comp B

<u>Increment no.</u>	<u>Length (in.)</u>	<u>Density (g/cm<sup>3</sup>)</u>	<u>Velocity (m/s)</u>
1	6.007	1.723	8143

DETONATION VELOCITY DATA

**Material:** Cyclotol, 75 wt% RDX/25 wt% TNT

**Experimenter:** E. James, Jr.      **Date:** January 8, 1951

**Shot no.:** GMX-2-10284; GMX-8-FL-3758

**Diameter:** 3 in. with 1/16 taper      **Average density:** 1.725 g/cm<sup>3</sup>

**Booster:** 1E15 detonator, P-040 lens, and 1-in.-long Comp B

<u>Increment no.</u>	<u>Length (in.)</u>	<u>Density (g/cm<sup>3</sup>)</u>	<u>Velocity (m/s)</u>
1	9.019	1.725	8225

**Material:** Cyclotol, 75 wt% RDX/25 wt% TNT

**Experimenter:** E. James, Jr.      **Date:** January 8, 1951

**Shot no.:** GMX-2-10285; GMX-8-FL-3757

**Diameter:** 3 in.      **Average density:** 1.727 g/cm<sup>3</sup>

**Booster:** 1E15 detonator, P-040 lens, and 1-in.-long Comp B

<u>Increment no.</u>	<u>Length (in.)</u>	<u>Density (g/cm<sup>3</sup>)</u>	<u>Velocity (m/s)</u>
1	9.018	1.727	8184

DETONATION VELOCITY DATA

**Material:** Cyclotol, 75 wt% RDX/25 wt% TNT

**Experimenter:** E. James, Jr.    **Date:** January 8, 1951

**Shot no.:** GMX-2-10287; GMX-8-FL-3760

**Diameter:** 1.5 in. (no taper)    **Average density:** 1.728 g/cm<sup>3</sup>

**Booster:** 1E15 detonator, P-015 lens, and 1-in.-long Comp B

<u>Increment no.</u>	<u>Length (in.)</u>	<u>Density (g/cm<sup>3</sup>)</u>	<u>Velocity (m/s)</u>
1	6.018	1.728	8180

**Material:** DATB

**Experimenter:** M. J. Urizar    **Date:** October 22, 1964

**Shot no.:** GMX-2-1664-C; GMX-8-E-2004

**Diameter:** 2 in.    **Average density:** 1.197 g/cm<sup>3</sup>    **Voids:** ~35%

**Fabrication:** Pressed into tubes    **Confinement:** 0.2-in. wall brass

<u>Increment no.</u>	<u>Length (in.)</u>	<u>Density (g/cm<sup>3</sup>)</u>
1	4.0015	1.197
2	4.0015	1.197
3	4.0015	1.197
4	4.0010	1.197
5	4.0015	1.197

**Average velocity of increments 2-4:** 5750 m/s

**DETONATION VELOCITY DATA**

**Material:** DATB

**Experimenter:** M. J. Urizar      **Date:** October 22, 1964

**Shot no.:** GMX-2-1664-A; GMX-8-E-1995

**Diameter:** 2 in.      **Average density:** 1.698 g/cm<sup>3</sup>      **Voids:** 7.46%

**Fabrication:** Pressed, machined, and fitted      **Confinement:** 0.2-in. brass tubes

<u>Increment no.</u>	<u>Length (in.)</u>	<u>Density (g/cm<sup>3</sup>)</u>
1	3.842	1.697
2	3.842	1.698
3	3.842	1.698
4	3.841	1.698
5	3.842	1.698

**Average velocity of increments 2-5:** 7264 m/s

DETONATION VELOCITY DATA

**Material:** DATB

**Experimenter:** M. J. Urizar      **Date:** October 22, 1964

**Shot no.:** GMX-2-1664-B; GMX-8-E-1996

**Diameter:** 2 in.      **Average density:** 1.698 g/cm<sup>3</sup>      **Voids:** 7.46%

**Fabrication:** Pressed, machined, and fitted      **Confinement:** 0.2-in. brass tubes

<u>Increment no.</u>	<u>Length (in.)</u>	<u>Density (g/cm<sup>3</sup>)</u>
1	3.841	1.697
2	3.842	1.697
3	3.842	1.699
4	3.842	1.698
5	3.842	1.698

**Average velocity of increments 2-5:** 7260 m/s

**DETONATION VELOCITY DATA**

**Material:** DATB

**Experimenter:** M. J. Urizar      **Date:** January 6, 1959

**Shot no.:** GMX-2-1278-B; GMX-8-E-872

**Diameter:** 1.006 in.      **Average density:** 1.788 g/cm<sup>3</sup>      **Voids:** 3.2%

**Fabrication:** Pressed and fitted      **Confinement:** 0.2-in. wall brass

**Booster:** 1E15 detonator, tetryl pellet, and 1.4-in.-diam by 4-in.-long TNT

<u>Increment no.</u>	<u>Length (in.)</u>	<u>Density (g/cm<sup>3</sup>)</u>
1	4.002	1.789
2	4.002	1.788
3	4.002	1.788

**Average velocity of increments 1-3:** 7497 m/s

DETONATION VELOCITY DATA

**Material:** DATB

**Experimenter:** M. J. Urizar     **Date:** January 6, 1959

**Shot no.:** GMX-2-1278-A; GMX-8-E-868

**Diameter:** 1.006 in.     **Average density:** 1.789 g/cm<sup>3</sup>     **Voids:** 3.2%

**Fabrication:** Pressed and fitted     **Confinement:** 0.2-in. wall brass

**Booster:** 1E15 detonator, tetryl pellet, and 1.4-in.-diam by 4-in.-long TNT

<u>Increment no.</u>	<u>Length (in.)</u>	<u>Density (g/cm<sup>3</sup>)</u>
1	4.003	1.790
2	4.003	1.788
3	4.002	1.789

**Average velocity of increments 1-3:** 7490 m/s



DETONATION VELOCITY DATA

**Material:** 92.36 wt% HMX/4.95 wt% DNPA/2.69 wt% DNPM

**Experimenter:** M. J. Urizar      **Date:** December 12, 1956

**Shot no.:** GMX-2-969-B; GMX-8-B-4121

**Diameter:** 1.625 in.      **Average density:** 1.806 g/cm<sup>3</sup>      **Voids:** 2.8%

**Fabrication:** Pressed and machined      **Unconfined**

**Booster:** 1E15 detonator and Comp B

<u>Increment no.</u>	<u>Length (in.)</u>	<u>Density (g/cm<sup>3</sup>)</u>	<u>Velocity (m/s)</u>
1	4.000	1.808	---
2	4.000	1.806	—
3	4.000	1.806	8679
4	4.000	1.806	8674
5	4.000	1.806	8679
6	4.000	1.807	8676
7	4.000	1.806	8675

**Average velocity of increments 3-7:** 8677 m/s

DETONATION VELOCITY DATA

**Material:** 92.36 wt% HMX/4.95 wt% DNPA/2.69 wt% DNPM

**Experimenter:** M. J. Urizar      **Date:** December 12, 1956

**Shot no.:** GMX-2-969-A; GMX-8-B-4120

**Diameter:** 1.807 in.      **Average density:** 1.807 g/cm<sup>3</sup>      **Voids:** 2.8%

**Fabrication:** Pressed in 6-in. vacuum mold      **Unconfined**

**Booster:** 1E15 detonator and Comp B

<u>Increment no.</u>	<u>Length (in.)</u>	<u>Density (g/cm<sup>3</sup>)</u>	<u>Velocity (m/s)</u>
1	4.000	1.806	---
2	4.000	1.809	---
3	4.000	1.808	8679
4	4.000	1.807	8674
5	4.000	1.808	8679
6	4.000	1.808	8676
7	4.000	1.808	8675

**Average velocity of increments 3-7:** 8677 m/s

DETONATION VELOCITY DATA

Material: 95 wt% HMX/5 wt% Exon

Experimenter: J. B. Panowski Date: August 6, 1954

Shot no.: GMX-2-344B; GMX-8-B-3268

Diameter: 1.625 in. Average density: 1.858 g/cm<sup>3</sup> Voids: 1.80%

Booster: 1E15 detonator and Comp B

<u>Increment no.</u>	<u>Length (in.)</u>	<u>Density (g/cm<sup>3</sup>)</u>	<u>Velocity (m/s)</u>
1	5.113	1.858	—
2	3.067	1.858	8814
3	3.067	1.858	8822
4	3.070	1.858	8810
5	3.069	1.858	8741

Average velocity of increments 2-5: 8797 m/s

## DETONATION VELOCITY DATA

**Material:** 95 wt% HMX/5 wt% Exon

**Experimenter:** J. B. Panowski    **Date:** August 6, 1954

**Shot no.:** GMX-2-344-A; GMX-8-B-3269

**Diameter:** 1.625 in.    **Average density:** 1.859 g/cm<sup>3</sup>    **Voids:** 1.74%

**Booster:** 1E15 detonator and Comp B

<u>Increment no.</u>	<u>Length (in.)</u>	<u>Density (g/cm<sup>3</sup>)</u>	<u>Velocity (m/s)</u>
1	6.134	1.859	---
2	3.067	1.859	8805
3	3.067	1.859	8801
4	3.069	1.859	8813
5	3.065	1.859	8795

**Average velocity of increments 2-5:** 8804 m/s

**DETONATION VELOCITY DATA**

**Material:** 90.5 wt% HMX/9.5 wt% Exon

**Experimenter:** E. James, Jr.     **Date:** August 17, 1954

**Shot no.:** GMX-2-347; GMX-8-B-3275

**Diameter:** 1.625 in.     **Average density:** 1.831 g/cm<sup>3</sup>     **Voids:** ~3%

**Booster:** 1E15 detonator

<u>Increment no.</u>	<u>Length (in.)</u>	<u>Velocity (m/s)</u>
1	4.000	8511
2	4.000	8548
3	4.000	8547
4	4.000	8555
5	4.000	8560
6	4.000	8556
7	4.000	8552

**Average velocity of increments 1-7:** 8547 m/s

## DETONATION VELOCITY DATA

**Material:** 90 wt% HMX/10 wt% Kel-F

**Experimenter:** F. DuBois      **Date:** May 4, 1954

**Shot no.:** GMX-2-267; GMX-8-B-3160

**Diameter:** 1.625 in.      **Average density:** 1.861 g/cm<sup>3</sup>      **Voids:** 2.9%

**Booster:** 1E15 detonator and Comp B

<u>Increment no.</u>	<u>Length (in.)</u>	<u>Density (g/cm<sup>3</sup>)</u>	<u>Velocity (m/s)</u>
1	3.875	1.863	---
2	4.000	1.861	8552
3	4.000	1.861	8552
4	4.000	1.861	8545
5	4.000	1.861	8551
6	4.000	1.861	8551

**Average velocity of increments 2-6:** 8550 m/s

DETONATION VELOCITY DATA

Material: 84.75 wt% HMX/15.25 wt% Kel-F

Experimenter: J. B. Panowski Date: June 18, 1954

Shot no.: GMX-2-293-C; GMX-8-B-3222

Diameter: 1.000 in. Average density: 1.869 g/cm<sup>3</sup> Voids: 2.3%

Booster: 1E15 detonator

<u>Increment no.</u>	<u>Length (in.)</u>	<u>Density (g/cm<sup>3</sup>)</u>	<u>Velocity (m/s)</u>
1	2.000	1.865	--
2	2.000	1.869	--
3	2.000	1.870	8455
4	2.000	1.870	8461
5	2.000	1.870	8465
6	2.000	1.870	8464
7	2.000	1.871	8360
8	2.000	1.870	8478

Average velocity of increments 2-6: 8447 m/s

DETONATION VELOCITY DATA

**Material:** 84.75 wt% HMX/15.25 wt% Kel-F

**Experimenter:** J. B. Panowski      **Date:** June 18, 1954

**Shot no.:** GMX-2-293-B; GMX-8-B-3215

**Diameter:** 0.333 in.      **Average density:** 1.870 g/cm<sup>3</sup>      **Voids:** 2.3%

**Booster:** 1E15 detonator

<u>Increment no.</u>	<u>Length (in.)</u>	<u>Density (g/cm<sup>3</sup>)</u>	<u>Velocity (m/s)</u>
1	2.000	1.868	---
2	2.000	1.878	---
3	2.000	1.870	8413
4	2.000	1.869	8409
5	2.000	1.868	8412
6	2.000	1.868	8413
7	2.000	1.870	8394
8	2.000	1.869	8415

**Average velocity of increments 3-8:** 8409 m/s



**DETONATION VELOCITY DATA**

**Material:** 84.75 wt% HMX/15.25 wt% Kel-F

**Experimenter:** J. B. Panowski      **Date:** June 18, 1954

**Shot no.:** GMX-2-293-A; GMX-8-B-3219

**Diameter:** 0.500 in.      **Average density:** 1.871 g/cm<sup>3</sup>      **Voids:** 2.3%

**Booster:** 1E15 detonator

<u>Increment no.</u>	<u>Length (in.)</u>	<u>Density (g/cm<sup>3</sup>)</u>	<u>Velocity (m/s)</u>
1	2.000	1.867	--
2	2.000	1.868	--
3	2.000	1.870	8442
4	2.000	1.872	8446
5	2.000	1.873	8441
6	2.000	1.878	8442
7	2.000	1.872	8438
8	2.000	1.874	8461

**Average velocity of increments 3-8:** 8445 m/s

DETONATION VELOCITY DATA

**Material:** 88.2 wt% HMX/11.8 wt% Kel-F

**Experimenter:** J. B. Panowski      **Date:** May 24, 1954

**Shot no.:** GMX-2-278; GMX-8-B-3182

**Diameter:** 1.625 in.      **Average density:** 1.871 g/cm<sup>3</sup>      **Unconfined**

<u>Increment no.</u>	<u>Length (in.)</u>	<u>Density (g/cm<sup>3</sup>)</u>	<u>Velocity (m/s)</u>
1	4.000	1.871	--
2	4.000	1.871	8622
3	4.000	1.871	8621
4	4.000	1.871	8618
5	4.000	1.871	8619
6	4.000	1.871	8621

**Average velocity of increments 2-6:** 8620 m/s

**DETONATION VELOCITY DATA**

**Material:** 41.63 wt% HMX/5.51 wt% Kel-F/52.86 wt% tungsten

**Experimenter:** M. J. Urizar      **Date:** November 7, 1955

**Shot no.:** GMX-2-845; GMX-8-B-3818

**Diameter:** 1.642 in.      **Average density:** 3.529 g/cm<sup>3</sup>      **Voids:** 3.3%

**Fabrication:** Pressed in 1.625-in. vacuum mold      **Unconfined**

**Booster:** 1E15 detonator and Comp B

<u>Increment no.</u>	<u>Length (in.)</u>	<u>Density (g/cm<sup>3</sup>)</u>	<u>Velocity (m/s)</u>
1	3.000	3.528	6748
2	3.000	3.529	6666
3	3.000	3.529	6742
4	3.000	3.529	6710
5	3.000	3.529	6692
6	3.000	3.529	6682
7	3.000	3.529	6742
8	3.000	3.530	6700
9	3.000	3.530	6699

**Average velocity of increments 1-9:** 6709 m/s

DETONATION VELOCITY DATA

**Material:** 90 wt% HMX/10 wt% methyl dekene

**Experimenter:** M. J. Urizar      **Date:** October 1, 1959

**Shot no.:** GMX-2-1358; GMX-8-996

**Diameter:** 1 in.      **Average density:** 1.656 g/cm<sup>3</sup>      **Voids:** 7.5%

**Fabrication:** Fitted into tubes      **Confinement:** 0.2-in. wall brass

**Booster:** 1E15 detonator and tetryl pellet

<u>Increment no.</u>	<u>Length (in.)</u>	<u>Density (g/cm<sup>3</sup>)</u>	<u>Velocity (m/s)</u>
1	1.913	1.641	8037
2	1.974	1.663	8152
3	1.908	1.663	7514

**Average velocity of increments 1-3:** 7901 m/s

**DETONATION VELOCITY DATA**

**Material:** 90 wt% HMX/10 wt% methyl dekene

**Experimenter:** M. J. Urizar      **Date:** October 1, 1959

**Shot no.:** GMX-2-1360; GMX-8-997

**Diameter:** 0.5 in.      **Average density:** 1.665 g/cm<sup>3</sup>      **Voids:** 7.5%

**Fabrication:** Fitted into tubes      **Confinement:** 0.2-in. wall brass

**Booster:** 1E15 detonator and tetryl pellet

<u>Increment no.</u>	<u>Length (in.)</u>	<u>Density (g/cm<sup>3</sup>)</u>	<u>Velocity (m/s)</u>
1	1.916	1.663	8142
2	1.951	1.666	8150
3	1.995	1.666	7096

**Average velocity of increments 1-3:** 7796 m/s

DETONATION VELOCITY DATA

Material: 90 wt% HMX/7.8 wt% PS/2.2 wt% DOP

Experimenter: K. Fess Date: July 21, 1952

Shot no.: GMX-2-9939, -41, -46, -48, -54, -66; GMX-8-B-1375

Diameter: 1.507 in. Average density: 1.6531 g/cm<sup>3</sup> Voids: 5.80%

Booster: 1E15 detonator and P-015 lens

<u>Increment no.</u>	<u>Length (in.)</u>	<u>Density (g/cm<sup>3</sup>)</u>
1	1.026	1.6524
2	1.030	1.6535
3	1.029	1.6526
4	1.027	1.6532
5	1.027	1.6531
6	1.028	1.6534
7	1.026	1.6534
8	1.027	1.6535

Average velocity of increments 3-8: 8073 m/s

**DETONATION VELOCITY DATA**

**Material:** 90 wt% HMX/7.8 wt% PS/2.2 wt% DOP

**Experimenter:** K. Fess      **Date:** July 21, 1954

**Shot no.:** GMX-2-9942, -44, -56, -58, -60, -64; GMX-8-B-1355

**Diameter:** 1.507 in.      **Average density:** 1.6541 g/cm<sup>3</sup>      **Voids:** 5.75%

**Booster:** 1E15 detonator and P-015 lens

<u>Increment no.</u>	<u>Length (in.)</u>	<u>Density (g/cm<sup>3</sup>)</u>
1	1.026	1.6535
2	1.027	1.6546
3	1.027	1.6539
4	1.028	1.6542
5	1.027	1.6542
6	1.027	1.6538
7	1.027	1.6545
8	1.026	1.6538

**Average velocity of increments 3-8:** 8098 m/s

DETONATION VELOCITY DATA

**Material:** 90 wt% HMX/7.8 wt% PS/2.2 wt% DOP

**Experimenter:** K. Fess      **Date:** July 21, 1954

**Shot no.:** GMX-2-9952, -59, -63, -65, -69, -70; GMX-8-B-1357

**Diameter:** 1.507 in.      **Average density:** 1.6573 g/cm<sup>3</sup>      **Voids:** 5.53%

**Booster:** 1E15 detonator and P-015 lens

<u>Increment no.</u>	<u>Length (in.)</u>	<u>Density (g/cm<sup>3</sup>)</u>
1	1.028	1.6547
2	1.030	1.6561
3	1.026	1.6576
4	1.028	1.6588
5	1.027	1.6572
6	1.028	1.6478
7	1.028	1.6580
8	1.028	1.6579

**Average velocity of increments 3-8:** 8094 m/s



DETONATION VELOCITY DATA

Material: 90 wt% HMX/7.8 wt% PS/2.2 wt% DOP

Experimenter: K. Fess Date: July 21, 1952

Shot no.: GMX-2-9935, -47, -51, -55, -61, -62; GMX-8-B-1358

Diameter: 1.507 in. Average density: 1.6518 g/cm<sup>3</sup> Voids: 5.88%

Booster: 1E15 detonator and P-015 lens

<u>Increment no.</u>	<u>Length (in.)</u>	<u>Density (g/cm<sup>3</sup>)</u>
1	1.027	1.6514
2	1.028	1.6524
3	1.026	1.6521
4	1.028	1.6515
5	1.026	1.6518
6	1.027	1.6520
7	1.026	1.6517
8	1.025	1.6520

Average velocity of increments 3-8: 8107 m/s

DETONATION VELOCITY DATA

**Material:** Octol, 75 wt% HMX/25 wt% TNT

**Experimenter:** M. J. Urizar      **Date:** January 15, 1957

**Shot no.:** GMX-2-975-A; GMX-8-B-4130

**Diameter:** 2.040 in.      **Average density:** 1.202 g/cm<sup>3</sup>      **Voids:** 34.5%

**Fabrication:** Pressed into tubes      **Confinement:** 0.2-in. wall brass

**Booster:** 1E15 detonator and Comp B

<u>Increment no.</u>	<u>Length (in.)</u>	<u>Density (g/cm<sup>3</sup>)</u>	<u>Velocity (m/s)</u>
1	3.000	1.198	--
2	3.000	1.204	--
3	3.000	1.202	--
4	3.000	1.202	6480
5	3.000	1.202	6472
6	3.000	1.202	6480
7	3.000	1.202	6486
8	3.000	1.201	6475

**Average velocity of increments 4-8:** 6479 m/s

DETONATION VELOCITY DATA

**Material:** Octol, 75 wt% HMX/25 wt% TNT

**Experimenter:** M. J. Urizar      **Date:** January 15, 1957

**Shot no.:** GMX-2-975-B; GMX-8-B-4131

**Diameter:** 2.040 in.      **Average density:** 1.202 g/cm<sup>3</sup>      **Voids:** 34.5%

**Fabrication:** Pressed into tubes      **Confinement:** 0.2-in. wall brass

**Booster:** 1E15 detonator and Comp B

<u>Increment no.</u>	<u>Length (in.)</u>	<u>Density (g/cm<sup>3</sup>)</u>	<u>Velocity (m/s)</u>
1	3.000	1.200	---
2	3.000	1.203	---
3	3.000	1.203	---
4	3.000	1.202	6469
5	3.000	1.200	6490
6	3.000	1.202	6472
7	3.000	1.201	6490
8	3.000	1.202	6475

**Average velocity of increments 4-8:** 6479 m/s

DETONATION VELOCITY DATA

Material: Octol, 75 wt% HMX/25 wt% TNT

Experimenter: M. J. Urizar Date: January 24, 1957

Shot no.: GMX-2-975-C; GMX-8-B-4132

Diameter: 4.080 in. Average density: 1.204 g/cm<sup>3</sup> Voids: 34.5%

Fabrication: Pressed into tubes Confinement: 0.2-in. wall brass

Booster: 1E15 detonator and Comp B

<u>Increment no.</u>	<u>Length (in.)</u>	<u>Density (g/cm<sup>3</sup>)</u>	<u>Velocity (m/s)</u>
1	6.001	1.197	6441
2	6.000	1.206	6475
3	6.000	1.206	6482
4	6.000	1.205	6484
5	6.001	1.205	6500
6	6.001	1.205	6495
7	6.000	1.205	6499
8	5.999	1.206	6493

Average velocity of increments 1-8: 6484 m/s

**DETONATION VELOCITY DATA**

**Material:** Octol, 75 wt% HMX/25 wt% TNT

**Experimenter:** M. J. Urizar      **Date:** January 24, 1957

**Shot no.:** GMX-2-975-D; GMX-8-B-4133

**Diameter:** 4.080 in.      **Average density:** 1.205 g/cm<sup>3</sup>      **Voids:** 34.5%

**Fabrication:** Pressed into tubes      **Confinement:** 0.2-in. wall brass

**Booster:** 1E15 detonator and Comp B

<u>Increment no.</u>	<u>Length (in.)</u>	<u>Density (g/cm<sup>3</sup>)</u>	<u>Velocity (m/s)</u>
1	6.001	1.206	6445
2	6.000	1.206	6450
3	6.001	1.204	6493
4	6.001	1.204	6493
5	6.000	1.205	6500
6	6.001	1.205	6489
7	6.001	1.205	6502
8	6.001	1.207	6495

**Average velocity of increments 1-8:** 6483 m/s

DETONATION VELOCITY DATA

Material: PBX 9205, 92 wt% RDX/6 wt% PS/2 wt% DOP

Experimenter: M. J. Urizar Date: August 21, 1953

Shot no.: GMX-2-027-4; GMX-8-FL-7239

Average density: 1.603 g/cm<sup>3</sup>

Booster: 1E15 detonator and Comp B

<u>Increment no.</u>	<u>Diam (in.)</u>	<u>Length (in.)</u>	<u>Density (g/cm<sup>3</sup>)</u>	<u>Velocity (m/s)</u>
1	1.5	1.000	1.661	---
2	1.5	1.000	1.664	---
3	1.5	1.000	1.656	8073
4	0.75	1.000	1.545	---
5	1.5	1.000	1.546	---
6	0.75	1.000	1.546	8156

Average velocity of increments: 8115 m/s

DETONATION VELOCITY DATA

**Material:** PBX 9205, 92 wt% RDX/6 wt% PS/2 wt% DOP

**Experimenter:** M. J. Urizar      **Date:** August 21, 1953

**Shot no.:** GMX-2-027-5; GMX-8-FL-7240

**Average density:** 1.602 g/cm<sup>3</sup>

**Booster:** 1E15 detonator and Comp B

<u>Increment no.</u>	<u>Diam (in.)</u>	<u>Length (in.)</u>	<u>Density (g/cm<sup>3</sup>)</u>	<u>Velocity (m/s)</u>
1	1.5	1.000	1.659	---
2	0.75	1.000	1.545	---
3	1.5	1.000	1.657	---
4	0.75	1.000	1.546	8130

**Material:** PBX 9205, 92 wt% RDX/6 wt% PS/2 wt% DOP

**Experimenter:** M. J. Urizar      **Date:** August 21, 1953

**Shot no.:** GMX-2-027-1; GMX-8-FL-7242

**Average density:** 1.603 g/cm<sup>3</sup>

**Booster:** 1E15 detonator and Comp B

<u>Increment no.</u>	<u>Diam (in.)</u>	<u>Length (in.)</u>	<u>Density (g/cm<sup>3</sup>)</u>	<u>Velocity (m/s)</u>
1	1.5	1.000	1.546	---
2	0.75	1.000	1.660	---
3	1.5	1.000	1.547	---
4	0.75	1.000	1.659	8188
5	1.5	1.000	1.547	---
6	0.75	1.000	1.660	8169

**Average velocity of increments 3-6:** 8179 m/s

DETONATION VELOCITY DATA

**Material:** PBX 9205, 92 wt% RDX/6 wt% PS/2 wt% DOP

**Experimenter:** M. J. Urizar      **Date:** August 21, 1953

**Shot no.:** GMX-2-027-7; GMX-8-FL-7241

**Average density:** 1.615 g/cm<sup>3</sup>

**Booster:** 1E15 detonator and Comp B

<u>Increment no.</u>	<u>Diam (in.)</u>	<u>Length (in.)</u>	<u>Density (g/cm<sup>3</sup>)</u>	<u>Velocity (m/s)</u>
1	1.5	1.000	1.547	---
2	1.0	1.000	1.659	---
3	0.5	1.000	1.662	---
4	1.5	0.950	1.625	---
5	1.0	0.950	1.548	---
6	0.5	0.950	1.659	8185
7	1.5	1.000	1.626	---
8	1.0	1.000	1.548	---
9	0.5	1.000	1.663	8180

**Average velocity of increments 5-9:** 8183 m/s



**DETONATION VELOCITY DATA**

**Material:** PBX 9205, 92 wt% RDX/6 wt% PS/2 wt% DOP

**Experimenter:** F. DuBois      **Date:** December 23, 1953

**Shot no.:** GMX-2-61-5; GMX-8-B-2959

**Diameter:** 1.625 in.      **Average density:** 1.682 g/cm<sup>3</sup>

**Fabrication:** Slurry, vacuum pressed, and machined

**Booster:** 1E15 detonator

<u>Increment no.</u>	<u>Length (in.)</u>	<u>Density (g/cm<sup>3</sup>)</u>	<u>Velocity (m/s)</u>
1	4.000	1.682	---
2	4.000	1.681	8285
3	4.000	1.682	8296
4	4.000	1.680	8283
5	4.000	1.682	8292
6	3.250	1.688	8292
7	4.000	1.682	8276

**Average velocity of increments 2-7:** 8287 m/s

DETONATION VELOCITY DATA

Material: PBX 9205, 92 wt% RDX/6 wt% PS/2 wt% DOP

Experimenter: M. J. Urizar Date: October 12, 1954

Shot no.: GMX-2-367-E; GMX-8-B-3324

Diameter: 3 in. Average density: 1.6839 g/cm<sup>3</sup> Voids: 1%

Fabrication: Fitted to Dural tubes Confinement: 0.5-in. wall steel

Booster: 1E15 detonator

<u>Increment no.</u>	<u>Length (in.)</u>	<u>Density (g/cm<sup>3</sup>)</u>	<u>Velocity (m/s)</u>
1	5.996	1.6835	---
2	5.997	1.6845	8279
3	5.996	1.6840	8275
4	5.997	1.6835	8279

Average velocity of increments 2-4: 8278 m/s

**DETONATION VELOCITY DATA**

**Material:** PBX 9205, 92 wt% RDX/6 wt% PS/2 wt% DOP

**Experimenter:** E. James, Jr.      **Date:** November 5, 1954

**Shot no.:** GMX-2-348-11; GMX-8-B-3337

**Diameter:** 0.100 in.      **Average density:** 1.685 g/cm<sup>3</sup>      **Voids:** <0.5%

**Booster:** 1E15 detonator

<b>Increment no.</b>	<b>Length (in.)</b>	<b>Velocity (m/s)</b>
1	2.000	8035
2	2.000	8045
3	2.000	8030
4	2.000	8027
5	2.000	8036
6	2.000	8048

**Average velocity of increments 1-6:** 8037 m/s

DETONATION VELOCITY DATA

Material: PBX 9205, 92 wt% RDX/6 wt% PS/2 wt% DOP

Experimenter: M. J. Urizar Date: October 15, 1954

Shot no.: GMX-2-367-L; GMX-8-B-3316

Diameter: 0.333 in. Average density: 1.686 g/cm<sup>3</sup> Voids: 1%

Fabrication: Fitted to tubes Confinement: 0.333-in. wall Dural

Booster: 1E15 detonator

<u>Increment no.</u>	<u>Length (in.)</u>	<u>Density (g/cm<sup>3</sup>)</u>	<u>Velocity (m/s)</u>
1	2.000	1.686	---
2	2.000	1.685	8247
3	2.000	1.686	8240
4	2.000	1.685	8252

Average velocity of increments 2-4: 8246 m/s

**DETONATION VELOCITY DATA**

**Material:** PBX 9205, 92 wt% RDX/6 wt% PS/2 wt% DOP

**Experimenter:** M. J. Urizar      **Date:** October 15, 1954

**Shot no.:** GMX-2-367-K; GMX-8-B-3317

**Diameter:** 0.333 in.      **Average density:** 1.686 g/cm<sup>3</sup>      **Voids:** 1%

**Fabrication:** Fitted to tubes

**Booster:** 1E15 detonator

<u>Increment no.</u>	<u>Length (in.)</u>	<u>Density (g/cm<sup>3</sup>)</u>	<u>Velocity (m/s)</u>
1	2.000	1.686	---
2	2.000	1.686	8253
3	2.000	1.687	8256
4	2.000	1.685	8240

**Average velocity of increments 2-4:** 8250 m/s

DETONATION VELOCITY DATA

**Material:** PBX 9205, 92 wt% RDX/6 wt% PS/2 wt% DOP

**Experimenter:** M. J. Urizar      **Date:** October 15, 1954

**Shot no.:** GMX-2-367-M; GMX-8-B-3314

**Diameter:** 0.333 in.      **Average density:** 1.686 g/cm<sup>3</sup>      **Voids:** 1%

**Fabrication:** Fitted to tubes      **Confinement:** 0.333-in. wall brass

**Booster:** 1E15 detonator

<u>Increment no.</u>	<u>Length (in.)</u>	<u>Density (g/cm<sup>3</sup>)</u>	<u>Velocity (m/s)</u>
1	1.998	1.685	---
2	2.000	1.685	8248
3	2.000	1.686	8254
4	2.000	1.686	8253

**Average velocity of increments 2-4:** 8252 m/s

**DETONATION VELOCITY DATA**

**Material:** PBX 9205, 92 wt% RDX/6 wt% PS/2 wt% DOP

**Experimenter:** M. J. Urizar      **Date:** October 15, 1954

**Shot no.:** GMX-2-367-J; GMX-8-B-3310

**Diameter:** 0.335 in.      **Average density:** 1.686 g/cm<sup>3</sup>      **Voids:** 1%

**Fabrication:** Fitted to tubes      **Confinement:** 0.333-in. wall brass

**Booster:** 1E15 detonator

<u>Increment no.</u>	<u>Length (in.)</u>	<u>Density (g/cm<sup>3</sup>)</u>	<u>Velocity (m/s)</u>
1	1.999	1.687	---
2	2.000	1.686	8254
3	2.000	1.685	8251
4	2.000	1.685	8241

**Average velocity of increments 2-4:** 8249 m/s

DETONATION VELOCITY DATA

Material: PBX 9205, 92 wt% RDX/6 wt% PS/2 wt% DOP

Experimenter: M. J. Urizar Date: October 15, 1954

Shot no.: GMX-2-367-N; GMX-8-B-3315

Diameter: 0.335 in. Average density: 1.686 g/cm<sup>3</sup> Voids: 1%

Fabrication: Fitted to tubes Confinement: 0.333-in. wall brass

Booster: 1E15 detonator

<u>Increment no.</u>	<u>Length (in.)</u>	<u>Density (g/cm<sup>3</sup>)</u>	<u>Velocity (m/s)</u>
1	1.999	1.686	---
2	1.998	1.685	8279
3	1.998	1.687	8259
4	2.000	1.687	8262

Average velocity of increments 2-4: 8267 m/s



**DETONATION VELOCITY DATA**

**Material:** PBX 9205, 92 wt% RDX/6 wt% PS/2 wt% DOP

**Experimenter:** M. J. Urizar      **Date:** October 15, 1954

**Shot no.:** GMX-2-367-O; GMX-8-B-3313

**Diameter:** 0.335 in.      **Average density:** 1.686 g/cm<sup>3</sup>      **Voids:** 1%

**Fabrication:** Fitted to tubes      **Confinement:** 0.085-in. wall Lucite

**Booster:** 1E15 detonator

<u>Increment no.</u>	<u>Length (in.)</u>	<u>Density (g/cm<sup>3</sup>)</u>	<u>Velocity (m/s)</u>
1	2.000	1.686	--
2	2.000	1.685	8266
3	1.998	1.686	8273
4	2.000	1.686	8278

**Average velocity of increments 2-4:** 8272 m/s

DETONATION VELOCITY DATA

**Material:** PBX 9205, 92 wt% RDX/6 wt% PS/2 wt% DOP

**Experimenter:** M. J. Urizar      **Date:** December 13, 1954

**Shot no.:** GMX-2-523-C; GMX-8-D-4920

**Diameter:** 0.335 in.      **Average density:** 1.685 g/cm<sup>3</sup>      **Voids:** 0.5%

**Fabrication:** Fitted to tubes; silicone-greased      **Confinement:** 0.083-in. wall Lucite

**Booster:** 1E15 detonator

<u>Increment no.</u>	<u>Length (in.)</u>	<u>Density (g/cm<sup>3</sup>)</u>	<u>Velocity (m/s)</u>
1	2.0000	1.685	---
2	2.0000	1.685	8284
3	2.0000	1.685	8287
4	2.0000	1.685	8264

**Average velocity of increments 2-4:** 8278 m/s

**DETONATION VELOCITY DATA**

**Material:** PBX 9205, 92 wt% RDX/6 wt% PS/2 wt% DOP

**Experimenter:** M. J. Urizar      **Date:** December 13, 1954

**Shot no.:** GMX-2-523-B; GMX-8-D-4919

**Diameter:** 0.335 in.      **Average density:** 1.685 g/cm<sup>3</sup>      **Voids:** 0.5%

**Fabrication:** Fitted to tubes; ungreased      **Confinement:** 0.083-in. wall Lucite

**Booster:** 1E15 detonator

<u>Increment no.</u>	<u>Length (in.)</u>	<u>Density (g/cm<sup>3</sup>)</u>	<u>Velocity (m/s)</u>
1	1.9993	1.685	---
2	2.0000	1.685	8275
3	1.9998	1.685	8286
4	2.0000	1.685	8294

**Average velocity of increments 2-4:** 8285 m/s

## DETONATION VELOCITY DATA

**Material:** PBX 9205, 92 wt% RDX/6 wt% PS/2 wt% DOP

**Experimenter:** M. J. Urizar      **Date:** December 13, 1954

**Shot no.:** GMX-2-523-A; GMX-8-D-4917

**Diameter:** 0.335 in.      **Average density:** 1.685 g/cm<sup>3</sup>      **Voids:** 0.5%

**Fabrication:** Fitted to tubes; ungreased      **Confinement:** 0.083-in. wall Lucite

**Booster:** 1E15 detonator

<u>Increment no.</u>	<u>Length (in.)</u>	<u>Density (g/cm<sup>3</sup>)</u>	<u>Velocity (m/s)</u>
1	2.0000	1.685	---
2	1.9995	1.685	8290
3	2.0000	1.685	8286
4	2.0000	1.685	8279

**Average velocity of increments 2-4:** 8285 m/s

**DETONATION VELOCITY DATA**

**Material:** PBX 9205, 92 wt% RDX/6 wt% PS/2 wt% DOP

**Experimenter:** M. J. Urizar      **Date:** December 13, 1954

**Shot no.:** GMX-2-523-D; GMX-8-D-4918

**Diameter:** 0.335 in.      **Average density:** 1.685 g/cm<sup>3</sup>      **Voids:** 0.5%

**Fabrication:** Fitted to tubes; silicone-greased      **Confinement:** 0.083-in. wall Lucite

**Booster:** 1E15 detonator

<u>Increment no.</u>	<u>Length (in.)</u>	<u>Density (g/cm<sup>3</sup>)</u>	<u>Velocity (m/s)</u>
1	2.0000	1.685	---
2	2.0000	1.686	8290
3	2.0000	1.686	8284
4	2.0000	1.686	8280

**Average velocity of increments 2-4:** 8285 m/s

DETONATION VELOCITY DATA

**Material:** PBX 9205, 92 wt% RDX/6 wt% PS/2 wt% DOP

**Experimenter:** E. James, Jr.    **Date:** May 12, 1953

**Shot no.:** GMX-2-13677; GMX-8-D-4042

**Diameter:** 1.625 in.    **Average density:** 1.6879 g/cm<sup>3</sup>    **Voids:** 0.94%

**Booster:** 1E15 detonator

<u>Increment no.</u>	<u>Length (in.)</u>	<u>Density (g/cm<sup>3</sup>)</u>	<u>Velocity (m/s)</u>
1	1.3677	1.6878	--
2	1.3677	1.6881	8263
3	1.3677	1.6880	8272
4	1.3677	1.6879	8264
5	1.3677	1.6879	8274

**Average velocity of increments 2-5:** 8268 m/s

**DETONATION VELOCITY DATA**

**Material:** PBX 9205, 92 wt% RDX/6 wt% PS/2 wt% DOP

**Experimenter:** F. DuBois      **Date:** December 9, 1953

**Shot no.:** GMX-2-61; GMX-8-B-2926

**Diameter:** 1.625 in.      **Average density:** 1.689 g/cm<sup>3</sup>      **Voids:** <0.7%

**Fabrication:** Slurry, vacuum pressed

**Booster:** 1E15 detonator

<u>Increment no.</u>	<u>Length (in.)</u>	<u>Density (g/cm<sup>3</sup>)</u>	<u>Velocity (m/s)</u>
1	3.250	1.689	---
2	3.250	1.686	8365
3	3.250	1.690	8371
4	3.250	1.688	8376
5	3.250	1.689	8367
6	3.250	1.690	8374

**Average velocity of increments 2-6:** 8371 m/s

DETONATION VELOCITY DATA

Material: PBX 9205, 92 wt% RDX/6 wt% PS/2 wt% DOP

Experimenter: M. J. Urizar Date: October 12, 1954

Shot no.: GMX-2-367-D; GMX-8-B-3318

Diameter: 3 in. Average density: 1.6850 g/cm<sup>3</sup> Voids: 1%

Fabrication: Fitted to steel tubes Confinement: 0.5-in. wall steel

Booster: 1E15 detonator

<u>Increment no.</u>	<u>Length (in.)</u>	<u>Density (g/cm<sup>3</sup>)</u>	<u>Velocity (m/s)</u>
1	5.996	1.6850	---
2	5.998	1.6850	8273
3	5.995	1.6840	8265
4	5.998	1.6840	8268

Average velocity of increments 2-4: 8269 m/s



**DETONATION VELOCITY DATA**

**Material:** PBX 9205, 92 wt% RDX/6 wt% PS/2 wt% DOP

**Experimenter:** M. J. Urizar      **Date:** October 12, 1954

**Shot no.:** GMX-2-367-C; GMX-8-B-3322

**Diameter:** 3 in.      **Average density:** 1.685 g/cm<sup>3</sup>      **Voids:** 1%

**Fabrication:** Fitted to steel tubes      **Confinement:** 0.5-in. wall steel

**Booster:** 1E15 detonator

<u>Increment no.</u>	<u>Length (in.)</u>	<u>Density (g/cm<sup>3</sup>)</u>	<u>Velocity (m/s)</u>
1	5.996	1.6845	---
2	5.998	1.6855	8266
3	5.998	1.6855	8278
4	5.997	1.6850	8278

**Average velocity of increments 2-4:** 8274 m/s

DETONATION VELOCITY DATA

**Material:** PBX 9205, 92 wt% RDX/6 wt% PS/2 wt% DOP

**Experimenter:** M. J. Urizar      **Date:** October 12, 1954

**Shot no.:** GMX-2-367-B; GMX-8-B-3323

**Diameter:** 3 in.      **Average density:** 1.685 g/cm<sup>3</sup>      **Voids:** 1%

**Fabrication:** Fitted brass tubes

**Booster:** 1E15 detonator

<u>Increment no.</u>	<u>Length (in.)</u>	<u>Density (g/cm<sup>3</sup>)</u>	<u>Velocity (m/s)</u>
1	5.997	1.6840	---
2	5.998	1.6850	8279
3	5.997	1.6840	8280
4	5.998	1.6845	8284

**Average velocity of increments 2-4:** 8281 m/s

**DETONATION VELOCITY DATA**

**Material:** PBX 9205, 92 wt% RDX/6 wt% PS/2 wt% DOP

**Experimenter:** M. J. Urizar      **Date:** October 12, 1954

**Shot no.:** GMX-2-367-A; GMX-8-B-3321

**Diameter:** 3 in.      **Average density:** 1.685 g/cm<sup>3</sup>      **Voids:** 1%

**Booster:** 1E15 detonator

<b>Increment no.</b>	<b>Length (in.)</b>	<b>Density (g/cm<sup>3</sup>)</b>	<b>Velocity (m/s)</b>
1	5.998	1.6850	---
2	5.999	1.6845	8283
3	5.999	1.6850	8284
4	5.999	1.6845	8278

**Average velocity of increments 2-4:** 8282 m/s

DETONATION VELOCITY DATA

**Material:** PBX 9205, 92 wt% RDX/6 wt% PS/2 wt% DOP

**Experimenter:** M. J. Urizar      **Date:** October 14, 1954

**Shot no.:** GMX-2-367-G; GMX-8-B-3319

**Diameter:** 3 in.      **Average density:** 1.686 g/cm<sup>3</sup>      **Voids:** 1%

**Fabrication:** Fitted to tubes      **Confinement:** 0.085-in. wall polystyrene

**Booster:** 1E15 detonator and Comp B

<u>Increment no.</u>	<u>Length (in.)</u>	<u>Density (g/cm<sup>3</sup>)</u>	<u>Velocity (m/s)</u>
1	6.000	1.692	---
2	6.000	1.684	8276
3	5.999	1.687	8284
4	6.000	1.686	8292

**Average velocity of increments 2-4:** 8284 m/s

**DETONATION VELOCITY DATA**

**Material:** PBX 9205, 92 wt% RDX/6 wt% PS/2 wt% DOP

**Experimenter:** M. J. Urizar      **Date:** October 14, 1954

**Shot no.:** GMX-2-367-H; GMX-8-B-3320

**Diameter:** 3 in.      **Average density:** 1.685 g/cm<sup>3</sup>      **Voids:** 1%

**Fabrication:** Fitted to tubes      **Confinement:** 0.085-in. wall polystyrene

**Booster:** 1E15 detonator and Comp B

<u>Increment no.</u>	<u>Length (in.)</u>	<u>Density (g/cm<sup>3</sup>)</u>	<u>Velocity (m/s)</u>
1	6.000	1.686	---
2	6.000	1.686	8289
3	5.998	1.686	8291
4	6.000	1.683	8274

**Average velocity of increments 2-4:** 8285 m/s

DETONATION VELOCITY DATA

**Material:** PBX 9205, 92 wt% RDX/6 wt% PS/2 wt% DOP

**Experimenter:** M. J. Urizar      **Date:** October 12, 1954

**Shot no.:** GMX-2-367-F; GMX-8-B-3325

**Diameter:** 3 in.      **Average density:** 1.685 g/cm<sup>3</sup>      **Voids:** 1%

**Fabrication:** Fitted to Dural tubes      **Confinement:** 0.5-in. wall Dural

**Booster:** 1E15 detonator

<u>Increment no.</u>	<u>Length (in.)</u>	<u>Density (g/cm<sup>3</sup>)</u>	<u>Velocity (m/s)</u>
1	5.996	1.6840	---
2	5.998	1.6850	8287
3	5.996	1.6855	8287
4	5.998	1.6850	8287

**Average velocity of increments 2-4:** 8287 m/s

**DETONATION VELOCITY DATA**

**Material:** PBX 9205, 92 wt% RDX/6 wt% PS/2 wt% DOP

**Experimenter:** E. James, Jr.      **Date:** November 5, 1954

**Shot no.:** GMX-2-367; GMX-8-B-3339

**Diameter:** 5.750 in.      **Average density:** 1.685 g/cm<sup>3</sup>      **Voids:** <0.5%

**Booster:** 1E15 detonator

<u>Increment no.</u>	<u>Length (in.)</u>	<u>Density (g/cm<sup>3</sup>)</u>	<u>Velocity (m/s)</u>
1	3.99	1.684	---
2	4.0005	1.686	---
3	4.001	1.685	8285
4	4.009	1.684	8286
5	4.000	1.685	8285
6	4.0005	1.685	8286

**Average velocity of increments:** 8286 m/s

DETONATION VELOCITY DATA

**Material:** Potassium dinitroacetonitrile

**Experimenter:** M. J. Urizar      **Date:** May 8, 1956

**Shot no.:** GMX-2-924; GMX-8-B-3891

**Diameter:** 0.25 in.      **Average density:** 1.912 g/cm<sup>3</sup>      **Voids:** 5.1%

**Fabrication:** Pressed into tubes      **Confinement:** 0.375-in. wall brass

**Booster:** 1E15 detonator

<u>Increment no.</u>	<u>Length (in.)</u>	<u>Density (g/cm<sup>3</sup>)</u>	<u>Velocity (m/s)</u>
1	1.9995	1.917	7508
2	1.9995	1.913	7506
3	1.9995	1.908	7398
4	1.9995	1.908	7390

**Average velocity of increments 1-4:** 7451 m/s



**DETONATION VELOCITY DATA**

**Material:** Hol-30-B RDX

**Experimenter:** M. J. Urizar      **Date:** December 13, 1955

**Shot no.:** GMX-2-825-D; GMX-8-B-3841

**Diameter:** 0.768 in.      **Average density:** 0.899 g/cm<sup>3</sup>      **Voids:** 50.5%

**Fabrication:** Pressed into tubes      **Confinement:** 0.2-in. wall brass

**Booster:** 1E15 detonator and Comp B

<u>Increment no.</u>	<u>Length (in.)</u>	<u>Density (g/cm<sup>3</sup>)</u>	<u>Velocity (m/s)</u>
1	3.005	0.898	5636
2	3.005	0.900	5543
3	3.005	0.899	5550
4	3.003	0.900	5539
5	3.005	0.898	5529
6	3.003	0.899	5536
7	3.005	0.900	5544
8	3.003	0.899	5540
9	3.003	0.900	5644

**Average velocity of increments 1-9:** 5562 m/s

DETONATION VELOCITY DATA

Material: Hol-30-B RDX

Experimenter: M. J. Urizar Date: December 12, 1955

Shot no.: GMX-2-825-C; GMX-8-B-3839

Diameter: 1.025 in. Average density: 0.898 g/cm<sup>3</sup> Voids: 50.5%

Fabrication: Pressed into tubes Confinement: 0.2-in. wall brass

Booster: 1E15 detonator and Comp B

<u>Increment no.</u>	<u>Length (in.)</u>	<u>Density (g/cm<sup>3</sup>)</u>	<u>Velocity (m/s)</u>
1	3.0003	0.898	5619
2	3.0000	0.898	5547
3	3.0002	0.898	5555
4	3.0003	0.899	5553
5	3.0000	0.899	5556
6	3.0006	0.900	5558
7	2.9998	0.898	5550
8	3.0005	0.898	5547
9	3.0000	0.897	5560

Average velocity of increments 1-9: 5561 m/s

**DETONATION VELOCITY DATA**

**Material:** Hol-30-B RDX

**Experimenter:** M. J. Urizar      **Date:** December 12, 1955

**Shot no.:** GMX-2-825-B; GMX-8-B-3838

**Diameter:** 1.538 in.      **Average density:** 0.898 g/cm<sup>3</sup>      **Voids:** 50.5%

**Fabrication:** Pressed into tubes      **Confinement:** 0.2-in. wall brass

**Booster:** 1E15 detonator and Comp B

<u>Increment no.</u>	<u>Length (in.)</u>	<u>Density (g/cm<sup>3</sup>)</u>	<u>Velocity (m/s)</u>
1	3.0002	0.897	5601
2	3.001	0.898	5559
3	3.0006	0.899	5577
4	3.0012	0.898	5576
5	3.001	0.898	5571
6	3.0003	0.898	5570
7	3.001	0.899	5572
8	3.0012	0.899	5576
9	3.0005	0.897	5576

**Average velocity of increments 1-9:** 5575 m/s

DETONATION VELOCITY DATA

Material: Hol-30-B RDX

Experimenter: M. J. Urizar Date: December 8, 1955

Shot no.: GMX-2-825-A; GMX-8-B-3837

Diameter: 3.080 in. Average density: 0.897 g/cm<sup>3</sup> Voids: 50.5%

Fabrication: Pressed into tubes Confinement: 0.2-in. wall brass

Booster: 1E15 detonator and Comp B

<u>Increment no.</u>	<u>Length (in.)</u>	<u>Density (g/cm<sup>3</sup>)</u>	<u>Velocity (m/s)</u>
1	6.001	0.898	5594
2	6.000	0.897	5569
3	6.001	0.896	5589
4	6.001	0.896	5590
5	6.000	0.896	5579
6	6.000	0.896	5586
7	6.000	0.896	5587
8	6.001	0.895	5579
9	6.000	0.896	5624

Average velocity of increments 1-9: 5589 m/s

**DETONATION VELOCITY DATA**

**Material:** NSJ-30B RDX

**Experimenter:** K. Fess     **Date:** July 17, 1952

**Shot no.:** GMX-2-9125; GMX-8-FL-6123

**Diameter:** 3.005 in.     **Average density:** 0.986 g/cm<sup>3</sup>     **Voids:** 45.69%

**Fabrication:** Hand tamped

**Confinement:** 0.0625-in. wall with 3-in.-i.d. polystyrene

**Booster:** 1E15 detonator and P-040 lens

<u>Increment no.</u>	<u>Length (in.)</u>	<u>Density (g/cm<sup>3</sup>)</u>	<u>Velocity (m/s)</u>
1	2.35	---	---
2	4.00	0.982	5926
3	4.00	0.989	5924
4	1.53	---	---

**Average velocity of increments 2 and 3:** 5925 m/s

DETONATION VELOCITY DATA

**Material:** RDX (GMX-3, jar milled)

**Experimenter:** M. J. Urizar      **Date:** April 16, 1953

**Shot no.:** GMX-2-13356; GMX-8-B-2370

**Diameter:** 0.25 in.      **Average density:** 0.997 g/cm<sup>3</sup>      **Voids:** 45%

**Fabrication:** Hand pressed

**Booster:** 1E15 detonator

<u>Increment no.</u>	<u>Length (in.)</u>	<u>Density (g/cm<sup>3</sup>)</u>	<u>Velocity (m/s)</u>
1	1.0000	0.994	--
2	1.0000	1.000	5689
3	1.0000	0.997	5613
4	0.9995	0.999	5657
5	1.0000	0.997	5659
6	0.9992	1.003	5730
7	0.2500	0.987	---

**Average velocity of increments 2-6:** 5670 m/s

DETONATION VELOCITY DATA

**Material:** RDX

**Experimenter:** F. DuBois     **Date:** July 11, 1953

**Shot no.:** GMX-2-13412; GMX-8-B-2580

**Diameter:** 0.25 in.     **Average density:** 1.00 g/cm<sup>3</sup>

**Fabrication:** Hand pressed     **Confinement:** 0.5-in. wall brass

**Booster:** 1E15 detonator and Comp B

<u>Increment no.</u>	<u>Length (in.)</u>	<u>Density (g/cm<sup>3</sup>)</u>	<u>Velocity (m/s)</u>
1	2.0000	1.006	---
2	2.0000	0.997	5754
3	2.0000	0.993	5769
4	2.0000	1.005	5724

**Average velocity of increments 2-4:** 5749 m/s

DETONATION VELOCITY DATA

**Material:** NSJ-30B RDX

**Experimenter:** F. DuBois    **Date:** July 1, 1953

**Shot no.:** GMX-2-13404; GMX-8-B-2541

**Diameter:** 0.2500 in.    **Average density:** 1.000 g/cm<sup>3</sup>    **Voids:** 44.8%

**Fabrication:** Hand pressed    **Confinement:** 0.0625-in. wall brass

**Booster:** 1E15 detonator and Comp B

<u>Increment no.</u>	<u>Length (in.)</u>	<u>Density (g/cm<sup>3</sup>)</u>	<u>Velocity (m/s)</u>
1	2.0000	1.003	---
2	2.0000	1.001	5771
3	2.0000	0.998	5749
4	2.0000	0.998	5756

**Average velocity of increments 2-4:** 5759 m/s



**DETONATION VELOCITY DATA**

**Material:** NSJ-30B RDX

**Experimenter:** F. DuBois      **Date:** June 18, 1953

**Shot no.:** GMX-2-13401; GMX-8-B-2514

**Diameter:** 0.25 in.      **Average density:** 1.000 g/cm<sup>3</sup>      **Voids:** 44.8%

**Fabrication:** Hand pressed      **Confinement:** 0.25-in. wall brass

**Booster:** 1E15 detonator and Comp B

<u>Increment no.</u>	<u>Length (in.)</u>	<u>Density (g/cm<sup>3</sup>)</u>	<u>Velocity (m/s)</u>
1	2.0000	1.000	----
2	2.0000	1.000	5776
3	2.0000	1.000	5772
4	2.0000	0.999	5764

**Average velocity of increments 2-4:** 5771 m/s

DETONATION VELOCITY DATA

**Material:** RDX (GMX-3, jar milled)

**Experimenter:** M. J. Urizar      **Date:** August 19, 1953

**Shot no.:** GMX-2-025; GMX-8-FL-7228

**Diameter:** 0.33 in.      **Average density:** 1.000 g/cm<sup>3</sup>      **Voids:** 44.75%

**Fabrication:** Pressed into brass      **Confinement:** 1-in.-o.d. brass

**Booster:** 1E15 detonator

<u>Increment no.</u>	<u>Length (in.)</u>	<u>Density (g/cm<sup>3</sup>)</u>	<u>Velocity (m/s)</u>
1	1.9995	1.002	---
2	1.9997	1.001	5802
3	1.9990	1.000	5737
4	1.9990	1.000	5745
5	0.3331	0.996	---

**Average velocity of increments 2-4:** 5761 m/s

DETONATION VELOCITY DATA

**Material:** RDX (GMX-3, jar milled)

**Experimenter:** M. J. Urizar      **Date:** August 14, 1953

**Shot no.:** GMX-2-023; GMX-8-FL-7230

**Diameter:** 0.33 in.      **Average density:** 1.000 g/cm<sup>3</sup>      **Voids:** 45%

**Fabrication:** Hand pressed into brass      **Confinement:** 1-in.-o.d. brass

**Booster:** 1E15 detonator

<u>Increment no.</u>	<u>Length (in.)</u>	<u>Density (g/cm<sup>3</sup>)</u>	<u>Velocity (m/s)</u>
1	1.9992	0.999	---
2	1.9992	1.001	5765
3	1.9992	1.001	5761
4	1.9992	1.000	5771
5	0.3328	1.000	---

**Average velocity of increments 2-4:** 5766 m/s

DETONATION VELOCITY DATA

Material: RDX (GMX-3, jar milled)

Experimenter: M. J. Urizar Date: April 16, 1953

Shot no.: GMX-2-13357; GMX-8-B-2369

Diameter: 0.5 in. Average density: 0.998 g/cm<sup>3</sup> Voids: 45%

Fabrication: Hand pressed

Booster: 1E15 detonator

<u>Increment no.</u>	<u>Length (in.)</u>	<u>Density (g/cm<sup>3</sup>)</u>	<u>Velocity (m/s)</u>
1	1.0000	0.997	---
2	0.9997	0.998	5866
3	0.9996	1.000	5806
4	1.0000	1.000	5834
5	1.0000	0.999	5810
6	1.0000	0.997	5810
7	0.5002	0.998	---

Average velocity of increments 2-6: 5825 m/s

DETONATION VELOCITY DATA

**Material:** RDX (GMX-3, jar milled)

**Experimenter:** M. J. Urizar      **Date:** April 30, 1953

**Shot no.:** GMX-2-13372; GMX-8-B-2398

**Diameter:** 0.5 in.      **Average density:** 0.999 g/cm<sup>3</sup>      **Voids:** 45%

**Fabrication:** Hand pressed

**Booster:** 1E15 detonator

<u>Increment no.</u>	<u>Length (in.)</u>	<u>Density (g/cm<sup>3</sup>)</u>	<u>Velocity (m/s)</u>
1	1.0000	1.007	--
2	0.9993	1.002	5792
3	1.0002	0.997	5846
4	0.9996	0.999	5798
5	1.0002	0.999	5944
6	0.9998	0.999	--
7	0.4997	0.991	---

**Average velocity of increments 2-5:** 5845 m/s

DETONATION VELOCITY DATA

**Material:** RDX (GMX-3, jar milled)

**Experimenter:** M. J. Urizar    **Date:** May 7, 1953

**Shot no.:** GMX-2-13390; GMX-8-B-2405

**Diameter:** 1 in.    **Average density:** 1.000 g/cm<sup>3</sup>    **Voids:** 44.75%

**Fabrication:** Hand pressed

**Booster:** 1E15 detonator, P-016 lens, and Comp B

<u>Increment no.</u>	<u>Length (in.)</u>	<u>Density (g/cm<sup>3</sup>)</u>	<u>Velocity (m/s)</u>
1	2.0003	0.998	--
2	2.0000	1.001	5884
3	2.0000	1.001	5893
4	2.0000	0.999	5899

**Average velocity of increments 2-4:** 5892 m/s

**DETONATION VELOCITY DATA**

**Material:** RDX (GMX-3, jar milled)

**Experimenter:** M. J. Urizar      **Date:** May 7, 1953

**Shot no.:** GMX-2-13391; GMX-8-B-2406

**Diameter:** 1 in.      **Average density:** 0.998 g/cm<sup>3</sup>      **Voids:** 44.75%

**Fabrication:** Hand pressed

**Booster:** 1E15 detonator, P-016 lens, and Comp B

<u>Increment no.</u>	<u>Length (in.)</u>	<u>Density (g/cm<sup>3</sup>)</u>	<u>Velocity (m/s)</u>
1	2.0000	0.997	---
2	2.0000	0.997	5903
3	2.0000	0.997	5885
4	2.0000	1.002	5947

**Average velocity of increments 2-4:** 5912 m/s

## DETONATION VELOCITY DATA

**Material:** NSJ-30B RDX

**Experimenter:** F. DuBois **Date:** July 16, 1953

**Shot no.:** GMX-2-13420; GMX-8-B-2592

**Diameter:** 1 in. **Average density:** 0.999 g/cm<sup>3</sup>

**Confinement:** 0.0625-in. wall brass

**Booster:** 1E15 detonator and Comp B

<u>Increment no.</u>	<u>Length (in.)</u>	<u>Density (g/cm<sup>3</sup>)</u>	<u>Velocity (m/s)</u>
1	2.0000	----	---
2	2.0000	0.999	5921
3	2.0000	0.999	5917
4	2.0000	0.998	5909

**Average velocity of increments 2-4:** 5916 m/s



**DETONATION VELOCITY DATA**

**Material:** NSJ-30B RDX

**Experimenter:** F. DuBois     **Date:** July 17, 1953

**Shot no.:** GMX-2-13422; GMX-8-B-2613

**Diameter:** 1 in.     **Average density:** 1.000 g/cm<sup>3</sup>

**Fabrication:** 1E15 detonator and Comp B

**Confinement:** 0.25-in. wall brass

**Booster:** 1E15 detonator and Comp B

<u>Increment no.</u>	<u>Length (in.)</u>	<u>Density (g/cm<sup>3</sup>)</u>	<u>Velocity (m/s)</u>
1	2.000	1.000	----
2	2.000	1.002	5919
3	2.000	0.997	5936
4	2.000	0.999	5923

**Average velocity of increments 2-4:** 5926 m/s

DETONATION VELOCITY DATA

**Material:** NSJ-30B RDX

**Experimenter:** F. DuBois      **Date:** July 17, 1953

**Shot no.:** GMX-2-13421; GMX-8-B-2612

**Diameter:** 1 in.      **Average density:** 0.999 g/cm<sup>3</sup>

**Confinement:** 0.5-in. wall brass

**Booster:** 1E15 detonator and Comp B

<u>Increment no.</u>	<u>Length (in.)</u>	<u>Density (g/cm<sup>3</sup>)</u>	<u>Velocity (m/s)</u>
1	2.000	---	---
2	2.000	0.998	5940
3	2.000	1.002	5918
4	2.000	0.998	5927

**Average velocity of increments 2-4:** 5928 m/s

**DETONATION VELOCITY DATA**

**Material:** NSJ-30B RDX

**Experimenter:** K. Fess     **Date:** July 18, 1952

**Shot no.:** GMX-2-9124; GMX-8-FL-6124

**Diameter:** 2.998 in.     **Average density:** 0.999 g/cm<sup>3</sup>     **Voids:** 45.03%

**Fabrication:** Hand tamped     **Confinement:** 0.25-in. wall with 2-in.-i.d. Lucite

**Booster:** 1E15 detonator and P-040 lens

<u>Increment no.</u>	<u>Length (in.)</u>	<u>Density (g/cm<sup>3</sup>)</u>	<u>Velocity (m/s)</u>
1	2.33	---	---
2	3.96	0.996	5896
3	4.00	1.001	5903
4	1.54	---	---

**Average velocity of increments 2 and 3:** 5900 m/s

DETONATION VELOCITY DATA

Material: NSJ-30B RDX

Experimenter: K. Fess     Date: July 18, 1952

Shot no.: GMX-2-9123; GMX-8-FL-6125

Diameter: 2.000 in.     Average density: 1.010 g/cm<sup>3</sup>     Voids: 44.20%

Fabrication: Hand tamped

Confinement: 0.0625-in. wall with 2-in.-i.d. polystyrene

Booster: 1E15 detonator and P-040 lens

<u>Increment no.</u>	<u>Length (in.)</u>	<u>Density (g/cm<sup>3</sup>)</u>	<u>Velocity (m/s)</u>
1	1.95	---	---
2	4.00	1.015	5991
3	4.02	1.004	5979
4	1.92	---	---

Average velocity of increments 2 and 3: 5985 m/s

**DETONATION VELOCITY DATA**

**Material:** NSJ-30B RDX

**Experimenter:** K. Fess      **Date:** July 18, 1952

**Shot no.:** GMX-2-9122; GMX-8-FL-6126

**Diameter:** 2.000 in.      **Average density:** 1.013 g/cm<sup>3</sup>      **Voids:** 44.03%

**Fabrication:** Hand tamped

**Confinement:** 0.0625-in. wall with 2-in.-i.d. polystyrene

**Booster:** 1E15 detonator and P-015 lens

<u>Increment no.</u>	<u>Length (in.)</u>	<u>Density (g/cm<sup>3</sup>)</u>	<u>Velocity (m/s)</u>
1	1.94	---	---
2	3.99	0.999	6006
3	3.97	1.018	6114
4	2.08	---	---

**Average velocity of increments 2 and 3:** 6010 m/s

DETONATION VELOCITY DATA

Material: NSJ-30B RDX

Experimenter: K. Fess Date: July 18, 1952

Shot no.: GMX-2-9126; GMX-8-FL-6121

Diameter: 3.005 in. Average density: 1.017 g/cm<sup>3</sup> Voids: 43.92%

Fabrication: Hand tamped

Confinement: 0.0625-in. wall with 3-in.-i.d. polystyrene

Booster: 1E15 detonator and P-040 lens

<u>Increment no.</u>	<u>Length (in.)</u>	<u>Density (g/cm<sup>3</sup>)</u>	<u>Velocity (m/s)</u>
1	2.42	---	---
2	3.97	1.018	6089
3	4.02	1.015	6109
4	1.57	---	---

Average velocity of increments 2 and 3: 6099 m/s

**DETONATION VELOCITY DATA**

**Material:** Hol-30-B RDX

**Experimenter:** M. J. Urizar      **Date:** April 4, 1956

**Shot no.:** GMX-2-922-A; GMX-8-B-3886

**Diameter:** 0.768 in.      **Average density:** 1.044 g/cm<sup>3</sup>      **Voids:** 42%

**Fabrication:** Pressed into tubes      **Confinement:** 0.2-in. wall brass

**Booster:** 1E15 detonator and Comp B

<u>Increment no.</u>	<u>Length (in.)</u>	<u>Density (g/cm<sup>3</sup>)</u>	<u>Velocity (m/s)</u>
1	3.001	1.042	6098
2	3.001	1.049	6093
3	3.001	1.045	6089
4	3.001	1.044	6082
5	3.001	1.044	6087
6	3.001	1.044	6086
7	3.001	1.044	6082
8	3.001	1.044	6074
9	3.001	1.043	6057

**Average velocity of increments 1-9:** 6083 m/s

DETONATION VELOCITY DATA

Material: Hol-30-B RDX

Experimenter: M. J. Urizar Date: April 5, 1956

Shot no.: GMX-2-922-B; GMX-8-B-3887

Diameter: 1.025 in. Average density: 1.050 g/cm<sup>3</sup> Voids: 42%

Fabrication: Pressed into tubes Confinement: 0.2-in. wall brass

Booster: 1E15 detonator and 1-in. by 1.025-in. Comp B

<u>Increment no.</u>	<u>Length (in.)</u>	<u>Density (g/cm<sup>3</sup>)</u>	<u>Velocity (m/s)</u>
1	3.001	1.049	6133
2	3.000	1.051	6131
3	3.000	1.051	6130
4	3.001	1.050	6131
5	3.000	1.051	6130
6	3.000	1.049	6127
7	3.000	1.050	6127
8	3.000	1.049	6127
9	3.000	1.049	6123

Average velocity of increments 1-9: 6129 m/s



DETONATION VELOCITY DATA

**Material:** Hol-30-B RDX

**Experimenter:** M. J. Urizar      **Date:** April 20, 1956

**Shot no.:** GMX-2-922-D; GMX-8-B-3889

**Diameter:** 3.078 in.      **Average density:** 1.049 g/cm<sup>3</sup>      **Voids:** 42%

**Fabrication:** Pressed into tubes      **Confinement:** 0.2-in. wall brass

**Booster:** 1E15 detonator and Comp B

<u>Increment no.</u>	<u>Length (in.)</u>	<u>Density (g/cm<sup>3</sup>)</u>	<u>Velocity (m/s)</u>
1	6.001	1.048	6128
2	6.001	1.048	6137
3	6.000	1.049	6156
4	6.001	1.049	6163
5	6.002	1.050	6178
6	6.001	1.049	6177
7	6.000	1.049	6174
8	6.001	1.048	6173
9	6.001	1.049	6164

**Average velocity of increments 1-9:** 6161 m/s

DETONATION VELOCITY DATA

**Material:** Hol-30-B RDX

**Experimenter:** M. J. Urizar      **Date:** April 9, 1956

**Shot no.:** GMX-2-922-C; GMX-8-B-3888

**Diameter:** 1.535 in.      **Average density:** 1.048 g/cm<sup>3</sup>      **Voids:** 42%

**Fabrication:** Pressed into tubes      **Confinement:** 0.2-in. wall brass

**Booster:** 1E15 detonator

<u>Increment no.</u>	<u>Length (in.)</u>	<u>Density (g/cm<sup>3</sup>)</u>	<u>Velocity (m/s)</u>
1	3.000	1.046	6126
2	3.000	1.049	6122
3	3.000	1.048	6127
4	3.001	1.048	6145
5	3.000	1.048	6142
6	3.000	1.049	6143
7	3.001	1.047	6142
8	3.000	1.048	6142
9	3.000	1.047	6126

**Average velocity of increments 1-9:** 6135 m/s

**DETONATION VELOCITY DATA**

**Material:** RDX (GMX-3, jar milled)

**Experimenter:** M. J. Urizar      **Date:** July 22, 1953

**Shot no.:** GMX-2-13424; GMX-8-B-2607

**Diameter:** 0.25 in.      **Average density:** 1.200 g/cm<sup>3</sup>      **Voids:** 34%

**Fabrication:** Pressed into tube      **Confinement:** 1-in. wall brass

**Booster:** 1E15 detonator

<u>Increment no.</u>	<u>Length (in.)</u>	<u>Density (g/cm<sup>3</sup>)</u>	<u>Velocity (m/s)</u>
1	0.9997	1.199	---
2	0.9995	1.198	6440
3	0.9998	1.200	6506
4	0.9997	1.204	6447
5	0.9998	1.196	6436
6	0.9998	1.194	6474
7	0.2500	1.210	---

**Average velocity of increments 2-6:** 6461 m/s

DETONATION VELOCITY DATA

**Material:** RDX (GMX-3, jar milled)

**Experimenter:** M. J. Urizar      **Date:** September 30, 1953

**Shot no.:** GMX-2-57-5; GMX-8-D-4226

**Diameter:** 0.25 in.      **Average density:** 1.200 g/cm<sup>3</sup>      **Voids:** 34%

**Fabrication:** Pressed in brass      **Confinement:** 0.375-in.-wall with 0.25-in.-i.d. brass

**Booster:** 1E15 detonator

<u>Increment no.</u>	<u>Length (in.)</u>	<u>Density (g/cm<sup>3</sup>)</u>	<u>Velocity (m/s)</u>
1	1.9995	1.200	---
2	1.9994	1.200	6490
3	1.9994	1.200	6508
4	1.9995	1.200	6487
5	0.2500	1.200	---

**Average velocity of increments 2-4:** 6495 m/s

**DETONATION VELOCITY DATA**

**Material:** RDX (GMX-3, jar milled)

**Experimenter:** M. J. Urizar      **Date:** October 2, 1953

**Shot no.:** GMX-2-59-5; GMX-8-B-2789

**Diameter:** 0.25 in.      **Average density:** 1.200 g/cm<sup>3</sup>      **Voids:** 34%

**Fabrication:** Pressed into brass      **Confinement:** 0.375-in. wall with 0.25-in. i.d. brass

**Booster:** 1E15 detonator

<u>Increment no.</u>	<u>Length (in.)</u>	<u>Density (g/cm<sup>3</sup>)</u>	<u>Velocity (m/s)</u>
1	1.9996	1.200	---
2	1.9993	1.200	6504
3	1.9995	1.200	6487
4	1.9993	1.200	6499
5	0.2500	1.200	---

**Average velocity of increments 2-4:** 6497 m/s

DETONATION VELOCITY DATA

Material: RDX (GMX-3, jar milled)

Experimenter: M. J. Urizar Date: August 19, 1953

Shot no.: GMX-2-026; GMX-8-B-2707

Diameter: 0.33 in. Average density: 1.200 g/cm<sup>3</sup> Voids: 33.70%

Fabrication: Pressed into brass Confinement: 1-in.-o.d. brass

Booster: 1E15 detonator

<u>Increment no.</u>	<u>Length (in.)</u>	<u>Density (g/cm<sup>3</sup>)</u>	<u>Velocity (m/s)</u>
1	1.9992	1.203	---
2	1.9994	1.193	6521
3	1.9990	1.202	6515
4	1.9993	1.203	6518
5	0.3330	1.199	---

Average velocity of increments 2-4: 6518 m/s

DETONATION VELOCITY DATA

Material: RDX (GMX-3, jar milled)

Experimenter: M. J. Urizar Date: August 14, 1953

Shot no.: GMX-2-022; GMX-8-FL-7229

Diameter: 0.33 in. Average density: 1.199 g/cm<sup>3</sup> Voids: 34%

Confinement: 1-in.-o.d. brass

Booster: 1E15 detonator

<u>Increment no.</u>	<u>Length (in.)</u>	<u>Density (g/cm<sup>3</sup>)</u>	<u>Velocity (m/s)</u>
1	1.9995	1.196	---
2	1.9995	1.198	6509
3	1.9993	1.200	6539
4	1.9995	1.199	6531
5	0.3328	1.201	---

Average velocity of increments 2-4: 6526 m/s

DETONATION VELOCITY DATA

Material: RDX (GMX-3, jar milled)

Experimenter: M. J. Urizar Date: October 2, 1953

Shot no.: GMX-2-59-4; GMX-8-B-2790

Diameter: 0.33 in. Average density: 1.201 g/cm<sup>3</sup> Voids: 34%

Fabrication: Pressed into brass Confinement: 0.33-in. wall with 0.33-in.-i.d. brass

Booster: 1E15 detonator

<u>Increment no.</u>	<u>Length (in.)</u>	<u>Density (g/cm<sup>3</sup>)</u>	<u>Velocity (m/s)</u>
1	1.9993	1.204	---
2	1.9994	1.204	6531
3	1.9995	1.205	6538
4	1.9995	1.206	6554
5	0.3350	1.184	---

Average velocity of increments 2-4: 6541 m/s



**DETONATION VELOCITY DATA**

**Material:** RDX (GMX-3, jar milled)

**Experimenter:** M. J. Urizar      **Date:** September 30, 1953

**Shot no.:** GMX-2-57-4; GMX-8-D-4225

**Diameter:** 0.33 in.      **Average density:** 1.196 g/cm<sup>3</sup>      **Voids:** 34%

**Fabrication:** Pressed into brass      **Confinement:** 0.33-in.-wall with 0.33-in.-i.d. brass

**Booster:** 1E15 detonator

<u>Increment no.</u>	<u>Length (in.)</u>	<u>Density (g/cm<sup>3</sup>)</u>	<u>Velocity (m/s)</u>
1	1.9992	1.198	--
2	1.9992	1.197	6562
3	1.9992	1.197	6552
4	1.9992	1.199	6530
5	0.3350	1.189	--

**Average velocity of increments 2-4:** 6548 m/s

DETONATION VELOCITY DATA

Material: RDX (GMX-3, jar milled)

Experimenter: M. J. Urizar Date: August 11, 1953

Shot no.: GMX-2-019; GMX-8-B-2690

Diameter: 0.5 in. Average density: 1.199 g/cm<sup>3</sup> Voids: 34%

Fabrication: Pressed into brass Confinement: 1-in.-o.d. brass

Booster: 1E15 detonator

<u>Increment no.</u>	<u>Length (in.)</u>	<u>Density (g/cm<sup>3</sup>)</u>	<u>Velocity (m/s)</u>
1	1.0001	1.201	---
2	1.0001	1.199	6582
3	1.0003	1.197	6526
4	1.0002	1.199	6532
5	1.0002	1.199	6535
6	1.0002	1.200	6542
7	0.5000	1.201	---

Average velocity of increments 2-6: 6543 m/s

**DETONATION VELOCITY DATA**

**Material:** RDX (GMX-3, jar milled)

**Experimenter:** M. J. Urizar      **Date:** July 10, 1953

**Shot no.:** GMX-2-13411; GMX-8-B-2575

**Diameter:** 0.5 in.      **Average density:** 1.199 g/cm<sup>3</sup>      **Void:** 33.7%

**Fabrication:** Hand pressed into tube      **Confinement:** 1-in.-o.d. brass

**Booster:** 1E15 detonator

<u>Increment no.</u>	<u>Length (in.)</u>	<u>Density (g/cm<sup>3</sup>)</u>	<u>Velocity (m/s)</u>
1	1.0003	1.196	---
2	1.0003	1.199	6582
3	1.0003	1.198	6526
4	1.0000	1.200	6532
5	1.0003	1.200	6535
6	1.0003	1.199	6542
7	0.5000	1.198	---

**Average velocity of increments 2-6:** 6543 m/s

DETONATION VELOCITY DATA

Material: RDX (GMX-3, jar milled)

Experimenter: M. J. Urizar Date: September 15, 1953

Shot no.: GMX-2-46-1; GMX-8-D-4200

Diameter: 0.5 in. Average density: 1.200 g/cm<sup>3</sup> Voids: 34%

Fabrication: Pressed into tubes Confinement: 0.75-in.-wall with 0.5-in.-i.d. brass

Booster: 1E15 detonator

<u>Increment no.</u>	<u>Length (in.)</u>	<u>Density (g/cm<sup>3</sup>)</u>	<u>Velocity (m/s)</u>
1	2.0000	1.200	---
2	2.0000	1.200	6535
3	2.0000	1.200	6550
4	2.0000	1.200	6554
5	0.5000	1.200	---

Average velocity of increments 2-4: 6546 m/s

**DETONATION VELOCITY DATA**

**Material:** RDX (GMX-3, jar milled)

**Experimenter:** M. J. Urizar      **Date:** October 2, 1953

**Shot no.:** GMX-2-59-3; GMX-8-B-2791

**Diameter:** 0.5 in.      **Average density:** 1.201 g/cm<sup>3</sup>      **Voids:** 34%

**Fabrication:** Pressed into brass      **Confinement:** 0.25-in. wall brass

**Booster:** 1E15 detonator

<u>Increment no.</u>	<u>Length (in.)</u>	<u>Density (g/cm<sup>3</sup>)</u>	<u>Velocity (m/s)</u>
1	2.0000	1.200	---
2	1.9994	1.201	6590
3	1.9995	1.201	6578
4	1.9995	1.200	6559
5	0.5000	1.201	---

**Average velocity of increments 2-4:** 6576 m/s

## DETONATION VELOCITY DATA

**Material:** RDX (jar milled)

**Experimenter:** M. J. Urizar      **Date:** August 27, 1953

**Shot no.:** GMX-2-40-1; GMX-8-B-2723

**Diameter:** 0.5 in.      **Average density:** 1.199 g/cm<sup>3</sup>      **Voids:** 34%

**Fabrication:** Pressed into tubes      **Confinement:** 0.25-in. wall brass

**Booster:** 1E15 detonator

<u>Increment no.</u>	<u>Length (in.)</u>	<u>Density (g/cm<sup>3</sup>)</u>	<u>Velocity (m/s)</u>
1	1.9994	1.201	---
2	1.9995	1.200	6580
3	1.9993	1.200	6575
4	1.9995	1.200	6578
5	0.5000	1.196	---

**Average velocity of increments 2-4:** 6578 m/s

DETONATION VELOCITY DATA

**Material:** RDX (GMX-3, jar milled)

**Experimenter:** M. J. Urizar      **Date:** September 30, 1953

**Shot no.:** GMX-2-57-3; GMX-8-D-4224

**Diameter:** 0.5 in.      **Average density:** 1.199 g/cm<sup>3</sup>      **Voids:** 34%

**Fabrication:** Pressed in brass      **Confinement:** 0.25-in.-wall with 0.5-in.-i.d. brass

**Booster:** 1E15 detonator

<u>Increment no.</u>	<u>Length (in.)</u>	<u>Density (g/cm<sup>3</sup>)</u>	<u>Velocity (m/s)</u>
1	1.9995	1.196	--
2	1.9994	1.200	6589
3	1.9996	1.202	6566
4	1.9995	1.196	6599
5	0.5000	1.201	--

**Average velocity of increments 2-4:** 6585 m/s

## DETONATION VELOCITY DATA

**Material:** RDX (GMX-3 32 and 33)

**Experimenter:** M. J. Urizar      **Date:** March 10, 1955

**Shot no.:** GMX-2-561-D; GMX-8-B-3525

**Diameter:** 0.75 in.      **Average density:** 1.199 g/cm<sup>3</sup>      **Voids:** 33.7%

**Fabrication:** Pressed into tubes      **Confinement:** 0.625-in. wall polystyrene

**Booster:** 1E15 detonator and Comp B

<u>Increment no.</u>	<u>Length (in.)</u>	<u>Density (g/cm<sup>3</sup>)</u>	<u>Velocity (m/s)</u>
1	3.001	1.197	---
2	3.001	1.200	6606
3	3.000	1.198	6604
4	3.001	1.200	6539
5	3.000	1.200	6603
6	3.001	1.197	6595

**Average velocity of increments 2-6:** 6589 m/s



DETONATION VELOCITY DATA

Material: RDX

Experimenter: M. J. Urizar Date: March 4, 1955

Shot no.: GMX-2-561-B; GMX-8-B-3520

Diameter: 0.75 in. Average density: 1.197 g/cm<sup>3</sup> Voids: 33%

Fabrication: Pressed into tubes Confinement: 0.625-in. wall Lucite

Booster: 1E15 detonator and Comp B

<u>Increment no.</u>	<u>Length (in.)</u>	<u>Density (g/cm<sup>3</sup>)</u>	<u>Velocity (m/s)</u>
1	3.001	1.189	---
2	3.001	1.196	6569
3	3.000	1.198	6608
4	3.000	1.198	6601
5	3.000	1.196	6582
6	3.000	1.198	6612
7	3.000	1.197	6594
8	3.000	1.201	6597

Average velocity of increments 2-8: 6595 m/s

DETONATION VELOCITY DATA

Material: RDX (jar milled)

Experimenter: M. J. Urizar Date: January 25, 1955

Shot no.: GMX-2-556-A, -B, -C; GMX-8-4968

Diameter: 0.75 in. Average density: 1.201 g/cm<sup>3</sup> Voids: 34%

Fabrication: Pressed into tubes Confinement: 0.25-in. wall brass

Booster: 1E15 detonator

<u>Increment no.</u>	<u>Length (in.)</u>	<u>Density (g/cm<sup>3</sup>)</u>	<u>Velocity (m/s)</u>
1	3.000	1.201	---
2	3.000	1.200	6605
3	3.000	1.199	6601
4	3.000	1.201	6657
5	2.999	1.202	6615
6	2.998	1.201	6648
7	3.000	1.201	6626
8	3.000	1.201	6628
9	3.001	1.200	6627
10	3.001	1.201	6619
11	3.001	1.201	6626
12	3.000	1.201	6624

Average velocity of increments 2-12: 6625 m/s

DETONATION VELOCITY DATA

Material: RDX (jar milled)

Experimenter: M. J. Urizar Date: January 25, 1955

Shot no.: GMX-2-556-D, -E, -F; GMX-8-D-4967

Diameter: 0.75 in. Average density: 1.199 g/cm<sup>3</sup> Voids: 34%

<u>Increment no.</u>	<u>Length (in.)</u>	<u>Density (g/cm<sup>3</sup>)</u>	<u>Velocity (m/s)</u>
1	3.000	1.196	6646
2	3.000	1.201	6599
3	3.000	1.200	6636
4	3.000	1.199	6650
5	3.000	1.195	6604
6	3.000	1.199	6635
7	3.000	1.198	6631
8	2.999	1.202	6647
9	3.001	1.200	6645
10	3.001	1.200	6621
11	2.999	1.201	6668

Average velocity of increments 1-11: 6635 m/s

DETONATION VELOCITY DATA

**Material:** RDX (GMX-3, jar milled)

**Experimenter:** M. J. Urizar      **Date:** September 30, 1953

**Shot no.:** GMX-2-57-2; GMX-8-D-4223

**Diameter:** 1 in.      **Average density:** 1.200 g/cm<sup>3</sup>      **Voids:** 34%

**Fabrication:** Pressed into tubes      **Confinement:** 0.5-in.-wall with 1-in.-i.d. brass

**Booster:** 1E15 detonator and Comp B

<u>Increment no.</u>	<u>Length (in.)</u>	<u>Density (g/cm<sup>3</sup>)</u>	<u>Velocity (m/s)</u>
1	2.0000	1.200	---
2	2.0000	1.200	6599
3	2.0000	1.200	6636
4	2.0000	1.200	6621

**Average velocity of increments 2-4:** 6619 m/s

DETONATION VELOCITY DATA

**Material:** RDX (GMX-3, jar milled)

**Experimenter:** M. J. Urizar      **Date:** October 2, 1953

**Shot no.:** GMX-2-59-2; GMX-8-B-2787

**Diameter:** 1 in.      **Average density:** 1.200 g/cm<sup>3</sup>      **Voids:** 34%

**Fabrication:** Pressed into brass      **Confinement:** 0.5-in. wall with 1-in.-i.d. brass

**Booster:** 1E15 detonator and Comp B

<u>Increment no.</u>	<u>Length (in.)</u>	<u>Density (g/cm<sup>3</sup>)</u>	<u>Velocity (m/s)</u>
1	2.0000	1.200	---
2	2.0000	1.200	6632
3	2.0000	1.200	6647
4	2.0000	1.200	6623

**Average velocity of increments 2-4:** 6634 m/s

DETONATION VELOCITY DATA

**Material:** RDX (GMX-3, jar milled)

**Experimenter:** M. J. Urizar      **Date:** May 25, 1953

**Shot no.:** GMX-2-13395; GMX-8-B-2452

**Diameter:** 1 in.      **Average density:** 1.196 g/cm<sup>3</sup>      **Voids:** 33.7%

**Fabrication:** Hand mold, air pressed

**Booster:** 1E15 detonator and Comp B      **Confinement:** 2-in.-o.d. brass

<u>Increment no.</u>	<u>Length (in.)</u>	<u>Density (g/cm<sup>3</sup>)</u>	<u>Velocity (m/s)</u>
1	2.000	1.188	--
2	2.000	1.199	6665
3	2.000	1.200	6668
4	2.000	1.197	6664

**Average velocity of increments 2-4:** 6666 m/s

DETONATION VELOCITY DATA

**Material:** RDX (GMX-3, jar milled)

**Experimenter:** M. J. Urizar      **Date:** May 25, 1953

**Shot no.:** GMX-2-13396; GMX-8-B-2451

**Diameter:** 1 in.      **Average density:** 1.201 g/cm<sup>3</sup>      **Voids:** 33.7%

**Fabrication:** Hand mold, air pressed      **Confinement:** 2-in.-o.d. brass

**Booster:** 1E15 detonator and Comp B

<u>Increment no.</u>	<u>Length (in.)</u>	<u>Density (g/cm<sup>3</sup>)</u>	<u>Velocity (m/s)</u>
1	2.0000	1.206	---
2	2.0000	1.197	6673
3	2.0000	1.199	6687
4	2.0000	1.200	6649

**Average velocity of increments 2-4:** 6670 m/s

DETONATION VELOCITY DATA

Material: Hol-30-B RDX

Experimenter: M. J. Urizar Date: January 6, 1956

Shot no.: GMX-2-879-B; GMX-8-B-3850

Diameter: 1.025 in. Average density: 1.199 g/cm<sup>3</sup> Voids: 44%

Fabrication: Pressed into tubes Confinement: 0.2-in. wall brass

Booster: 1E15 detonator and Comp B

<u>Increment no.</u>	<u>Length (in.)</u>	<u>Density (g/cm<sup>3</sup>)</u>	<u>Velocity (m/s)</u>
1	3.000	1.193	6629
2	3.000	1.196	6684
3	3.000	1.196	6665
4	3.0005	1.199	6691
5	3.000	1.199	6689
6	3.000	1.200	6695
7	3.000	1.201	6698
8	3.0005	1.202	6797
9	3.0005	1.204	6701

Average velocity of increments 1-9: 6694 m/s



DETONATION VELOCITY DATA

**Material:** RDX (GMX-3, jar milled)

**Experimenter:** M. J. Urizar      **Date:** January 8, 1954

**Shot no.:** GMX-2-132; GMX-8-B-3040

**Diameter:** 1.5 in.      **Average density:** 1.196 g/cm<sup>3</sup>      **Voids:** 34%

**Fabrication:** Pressed into polystyrene tubes      **Confinement:** Polystyrene

**Booster:** 1E15 detonator and Comp B

<u>Increment no.</u>	<u>Length (in.)</u>	<u>Density (g/cm<sup>3</sup>)</u>	<u>Velocity (m/s)</u>
1	6.002	1.197	---
2	6.007	1.195	6689
3	6.000	1.196	6675

**Average velocity of increments 2 and 3:** 6682 m/s

DETONATION VELOCITY DATA

**Material:** RDX (GMX-3, jar milled)

**Experimenter:** M. J. Urizar      **Date:** August 21, 1953

**Shot no.:** GMX-2-032-2; GMX-8-FL-7246

**Diameter:** 2 in.      **Average density:** 1.200 g/cm<sup>3</sup>      **Voids:** 33.7%

**Fabrication:** Air pressed into brass      **Confinement:** 0.5-in.-wall with 3-in.-o.d. brass

**Booster:** 1E15 detonator and Comp B

<u>Increment no.</u>	<u>Length (in.)</u>	<u>Density (g/cm<sup>3</sup>)</u>	<u>Velocity (m/s)</u>
1	2.0000	1.200	---
2	2.0000	1.200	6621
3	1.9995	1.200	6617
4	2.0000	1.200	6605

**Average velocity of increments 2-4:** 6614 m/s

DETONATION VELOCITY DATA

**Material:** RDX (GMX-3, jar milled)

**Experimenter:** M. J. Urizar      **Date:** August 21, 1953

**Shot no.:** GMX-2-032-1; GMX-8-B-2716

**Diameter:** 2 in.      **Average density:** 1.200 g/cm<sup>3</sup>      **Voids:** 33.7%

**Fabrication:** Air pressed into brass      **Confinement:** 0.5-in.-wall with 3-in.-o.d. brass

**Booster:** 1E15 detonator and Comp B

<u>Increment no.</u>	<u>Length (in.)</u>	<u>Density (g/cm<sup>3</sup>)</u>	<u>Velocity (m/s)</u>
1	2.0000	1.200	--
2	2.0000	1.200	6661
3	2.0000	1.200	6613
4	2.0000	1.200	6624

**Average velocity of increments 2-4:** 6633 m/s

DETONATION VELOCITY DATA

Material: RDX (GMX-3, jar milled)

Experimenter: M. J. Urizar Date: October 2, 1953

Shot no.: GMX-2-59-1; GMX-8-B-2788

Diameter: 2 in. Average density: 1.200 g/cm<sup>3</sup> Voids: 34%

Fabrication: Pressed into brass Confinement: 0.5-in. wall with 2-in.-i.d. brass

Booster: 1E15 detonator and Comp B

<u>Increment no.</u>	<u>Length (in.)</u>	<u>Density (g/cm<sup>3</sup>)</u>	<u>Velocity (m/s)</u>
1	1.9984	1.200	---
2	2.0000	1.200	6669
3	1.9996	1.200	6650
4	1.9997	1.200	6654

Average velocity of increments 2-4: 6658 m/s

DETONATION VELOCITY DATA

**Material:** RDX (GMX-3, jar milled)

**Experimenter:** M. J. Urizar      **Date:** September 30, 1953

**Shot no.:** GMX-2-57-1; GMX-8-B-2779

**Diameter:** 2 in.      **Average density:** 1.200 g/cm<sup>3</sup>      **Voids:** 34%

**Fabrication:** Pressed into brass      **Confinement:** 0.5-in.-wall with 2-in.-i.d. brass

**Booster:** 1E15 detonator and Comp B

<u>Increment no.</u>	<u>Length (in.)</u>	<u>Density (g/cm<sup>3</sup>)</u>	<u>Velocity (m/s)</u>
1	1.9968	1.200	--
2	2.0000	1.200	6653
3	1.9998	1.200	6653
4	2.0000	1.200	6682

**Average velocity of increments 2-4:** 6663 m/s

DETONATION VELOCITY DATA

**Material:** RDX (GMX-3, jar milled)

**Experimenter:** M. J. Urizar      **Date:** March 17, 1954

**Shot no.:** GMX-2-226; GMX-8-D-4451

**Diameter:** 3 in.      **Average density:** 1.200 g/cm<sup>3</sup>      **Voids:** 34%

**Fabrication:** Pressed into tube      **Confinement:** 0.5-in. wall with 3-in.-i.d. brass

**Booster:** 1E15 detonator and Comp B

<u>Increment no.</u>	<u>Length (in.)</u>	<u>Density (g/cm<sup>3</sup>)</u>	<u>Velocity (m/s)</u>
1	6.000	1.200	--
2	6.000	1.200	6676
3	6.000	1.200	6703
4	6.000	1.200	6684
5	6.000	1.200	6671

**Average velocity of increments 2-5:** 6684 m/s

DETONATION VELOCITY DATA

**Material:** RDX (GMX-3, jar milled)

**Experimenter:** M. J. Urizar      **Date:** February 19, 1954

**Shot no.:** GMX-2-197; GMX-8-D-4406

**Diameter:** 3 in.      **Average density:** 1.199 g/cm<sup>3</sup>      **Voids:** 34%

**Fabrication:** Pressed into brass      **Confinement:** 0.5-in. wall with 3-in.-i.d. brass

**Booster:** 1E15 detonator

<u>Increment no.</u>	<u>Length (in.)</u>	<u>Density (g/cm<sup>3</sup>)</u>	<u>Velocity (m/s)</u>
1	3.000	1.197	--
2	3.000	1.200	--
3	3.000	1.200	6697
4	3.000	1.200	6682
5	3.000	1.200	6733
6	3.000	1.198	6649
7	3.000	1.197	6655
8	3.000	1.200	6702

**Average velocity of increments 3-8:** 6686 m/s

DETONATION VELOCITY DATA

**Material:** RDX (GMX-3, jar milled)

**Experimenter:** M. J. Urizar      **Date:** January 5, 1955

**Shot no.:** GMX-2-554; GMX-8-D-4943

**Diameter:** 3.0 in.      **Average density:** 1.195 g/cm<sup>3</sup>      **Voids:** 34%

**Fabrication:** Pressed into tubes      **Confinement:** Polystyrene

**Booster:** 1E15 detonator

<u>Increment no.</u>	<u>Length (in.)</u>	<u>Density (g/cm<sup>3</sup>)</u>	<u>Velocity (m/s)</u>
1	5.998	1.196	---
2	5.998	1.195	6697
3	5.998	1.195	6695
4	5.998	1.195	6698

**Average velocity of increments 2-4:** 6697 m/s



**DETONATION VELOCITY DATA**

**Material:** RDX (GMX-3, jar milled)

**Experimenter:** M. J. Urizar      **Date:** March 17, 1954

**Shot no.:** GMX-2-227; GMX-8-D-4449

**Diameter:** 3 in.      **Average density:** 1.200 g/cm<sup>3</sup>      **Voids:** 34%

**Fabrication:** Pressed into tube      **Confinement:** 0.5-in. wall steel

**Booster:** 1E15 detonator and Comp B

<u>Increment no.</u>	<u>Length (in.)</u>	<u>Density (g/cm<sup>3</sup>)</u>	<u>Velocity (m/s)</u>
1	6.000	1.200	---
2	6.000	1.200	6711
3	6.000	1.200	6714
4	6.000	1.200	6690
5	6.000	1.200	6684

**Average velocity of increments 2-5:** 6700 m/s

DETONATION VELOCITY DATA

Material: RDX (GMX-3, jar milled)

Experimenter: M. J. Urizar Date: March 17, 1954

Shot no.: GMX-2-225; GMX-8-D-4450

Diameter: 3 in. Average density: 1.200 g/cm<sup>3</sup> Voids: 34%

Fabrication: Pressed into tube Confinement: 0.5-in. wall Dural

Booster: 1E15 detonator

<u>Increment no.</u>	<u>Length (in.)</u>	<u>Density (g/cm<sup>3</sup>)</u>	<u>Velocity (m/s)</u>
1	6.000	1.200	---
2	6.000	1.202	6708
3	6.000	1.199	6688
4	6.000	1.199	6700
5	6.000	1.199	6705

Average velocity of increments 2-5: 6700 m/s

DETONATION VELOCITY DATA

**Material:** RDX (GMX-3, jar milled)

**Experimenter:** M. J. Urizar      **Date:** January 7, 1955

**Shot no.:** GMX-2-555-E; GMX-8-D-4939

**Diameter:** 3.0 in.      **Average density:** 1.202 g/cm<sup>3</sup>      **Voids:** 34%

**Fabrication:** Pressed into tubes      **Confinement:** 1.2-in. wall Dural

**Booster:** 1E15 detonator

<u>Increment no.</u>	<u>Length (in.)</u>	<u>Density (g/cm<sup>3</sup>)</u>	<u>Velocity (m/s)</u>
1	6.001	1.202	--
2	6.000	1.202	6680
3	6.000	1.202	6712
4	6.001	1.201	6730

**Average velocity of increments 2-4:** 6707 m/s

DETONATION VELOCITY DATA

**Material:** RDX (GMX-3, jar milled)

**Experimenter:** M. J. Urizar      **Date:** January 7, 1955

**Shot no.:** GMX-2-555-F; GMX-8-D-4940

**Diameter:** 3.0 in.      **Average density:** 1.202 g/cm<sup>3</sup>      **Voids:** 34%

**Fabrication:** Pressed into tubes      **Confinement:** 1.2-in. wall Dural

**Booster:** 1E15 detonator

<u>Increment no.</u>	<u>Length (in.)</u>	<u>Density (g/cm<sup>3</sup>)</u>	<u>Velocity (m/s)</u>
1	6.000	1.202	---
2	6.000	1.202	6687
3	6.000	1.202	6712
4	6.000	1.202	6734

**Average velocity of increments 2-4:** 6711 m/s

**DETONATION VELOCITY DATA**

**Material:** RDX (GMX-3, jar milled)

**Experimenter:** M. J. Urizar      **Date:** January 7, 1955

**Shot no.:** GMX-2-555-A; GMX-8-D-4946

**Diameter:** 3.0 in.      **Average density:** 1.202 g/cm<sup>3</sup>      **Voids:** 34%

**Fabrication:** Pressed into tubes      **Confinement:** 0.5-in. wall brass

**Booster:** 1E15 detonator

<u>Increment no.</u>	<u>Length (in.)</u>	<u>Density (g/cm<sup>3</sup>)</u>	<u>Velocity (m/s)</u>
1	6.002	1.202	---
2	6.002	1.202	6708
3	6.001	1.202	6705
4	6.001	1.202	6734

**Average velocity of increments 2-4:** 6716 m/s

DETONATION VELOCITY DATA

**Material:** RDX (GMX-3, jar milled)

**Experimenter:** M. J. Urizar      **Date:** January 7, 1955

**Shot no.:** GMX-2-555-D; GMX-8-D-4941

**Diameter:** 3.0 in.      **Average density:** 1.201 g/cm<sup>3</sup>      **Voids:** 34%

**Fabrication:** Pressed into tubes      **Confinement:** 1.2-in. wall Dural

**Booster:** 1E15 detonator

<u>Increment no.</u>	<u>Length (in.)</u>	<u>Density (g/cm<sup>3</sup>)</u>	<u>Velocity (m/s)</u>
1	6.001	1.198	---
2	6.001	1.202	6705
3	6.001	1.202	6722
4	6.001	1.202	6725

**Average velocity of increments 2-4:** 6717 m/s

DETONATION VELOCITY DATA

**Material:** RDX

**Experimenter:** M. J. Urizar      **Date:** August 24, 1954

**Shot no.:** GMX-2-358-A; GMX-B-3276

**Diameter:** 3 in.      **Average density:** 1.200 g/cm<sup>3</sup>      **Voids:** 33.7%

**Fabrication:** Pressed into tubes      **Confinement:** 0.5-in. wall Dural

**Booster:** 1E15 detonator and P-016 lens

<u>Increment no.</u>	<u>Length (in.)</u>	<u>Density (g/cm<sup>3</sup>)</u>	<u>Velocity (m/s)</u>
1	5.999	1.202	---
2	6.000	1.200	6720
3	6.000	1.199	6722
4	5.999	1.200	6711

**Average velocity of increments 2-4:** 6718 m/s

DETONATION VELOCITY DATA

**Material:** RDX (GMX-3, jar milled)

**Experimenter:** M. J. Urizar      **Date:** January 12, 1954

**Shot no.:** GMX-2-131; GMX-8-FL-7588

**Diameter:** 3 in.      **Average density:** 1.197 g/cm<sup>3</sup>      **Voids:** 34%

**Fabrication:** Pressed into polystyrene tubes      **Confinement:** Polystyrene

**Booster:** 1E15 detonator and Comp B

<u>Increment no.</u>	<u>Length (in.)</u>	<u>Density (g/cm<sup>3</sup>)</u>	<u>Velocity (m/s)</u>
1	12	1.197	---
2	12	1.196	6708
3	12	1.197	6729

**Average velocity of increments 2 and 3:** 6719 m/s



DETONATION VELOCITY DATA

**Material:** RDX

**Experimenter:** M. J. Urizar     **Date:** January 7, 1955

**Shot no.:** GMX-2-555-B; GMX-8-D-4945

**Diameter:** 3.0 in.     **Average density:** 1.202 g/cm<sup>3</sup>     **Voids:** 34%

**Fabrication:** Pressed into tubes     **Confinement:** 0.5-in. wall brass

**Booster:** 1E15 detonator

<u>Increment no.</u>	<u>Length (in.)</u>	<u>Density (g/cm<sup>3</sup>)</u>	<u>Velocity (m/s)</u>
1	6.002	1.202	---
2	6.002	1.202	6710
3	6.002	1.202	6718
4	6.002	1.202	6728

**Average velocity of increments 2-4:** 6719 m/s

DETONATION VELOCITY DATA

**Material:** RDX (GMX-3, jar milled)

**Experimenter:** M. J. Urizar      **Date:** January 7, 1955

**Shot no.:** GMX-2-555-C; GMX-8-D-4944

**Diameter:** 3.0 in.      **Average density:** 1.202 g/cm<sup>3</sup>      **Voids:** 34%

**Fabrication:** Pressed into tubes      **Confinement:** 0.5-in. wall brass

**Booster:** 1E15 detonator

<u>Increment no.</u>	<u>Length (in.)</u>	<u>Density (g/cm<sup>3</sup>)</u>	<u>Velocity (m/s)</u>
1	6.002	1.202	---
2	6.002	1.202	6708
3	6.002	1.202	6719
4	6.002	1.202	6736

**Average velocity of increments 2-4:** 6721 m/s

**DETONATION VELOCITY DATA**

**Material:** RDX (GMX-3, jar milled)

**Experimenter:** M. J. Urizar      **Date:** March 17, 1954

**Shot no.:** GMX-2-224; GMX-8-D-4452

**Diameter:** 3 in.      **Average density:** 1.201 g/cm<sup>3</sup>      **Voids:** 34%

**Fabrication:** Pressed into tube      **Confinement:** Polystyrene

**Booster:** 1E15 detonator

<u>Increment no.</u>	<u>Length (in.)</u>	<u>Density (g/cm<sup>3</sup>)</u>	<u>Velocity (m/s)</u>
1	5.991	1.202	---
2	6.000	1.203	6707
3	5.997	1.197	6744
4	6.000	1.199	6730
5	6.001	1.202	---

**Average velocity of increments 2-4:** 6727 m/s

DETONATION VELOCITY DATA

**Material:** RDX (GMX-3, jar milled)

**Experimenter:** M. J. Urizar      **Date:** February 19, 1954

**Shot no.:** GMX-2-198; GMX-8-D-4405

**Diameter:** 3 in.      **Average density:** 1.202 g/cm<sup>3</sup>      **Voids:** 34%

**Fabrication:** Pressed into polystyrene      **Confinement:** Polystyrene

**Booster:** 1E15 detonator and Comp B

<u>Increment no.</u>	<u>Length (in.)</u>	<u>Density (g/cm<sup>3</sup>)</u>	<u>Velocity (m/s)</u>
1	12.001	1.202	---
2	12.000	1.201	6729
3	12.000	1.202	6739
4	12.002	1.203	6733
5	12.001	1.203	6736

**Average velocity of increments 2-5:** 6734 m/s

DETONATION VELOCITY DATA

**Material:** Hol-30-B RDX

**Experimenter:** M. J. Urizar      **Date:** January 18, 1956

**Shot no.:** GMX-2-879-D; GMX-8-B-3852

**Diameter:** 3.079 in.      **Average density:** 1.197 g/cm<sup>3</sup>      **Voids:** 44%

**Fabrication:** Pressed into tubes      **Confinement:** 0.2-in. wall brass

**Booster:** 1E15 detonator and Comp B

<u>Increment no.</u>	<u>Length (in.)</u>	<u>Density (g/cm<sup>3</sup>)</u>	<u>Velocity (m/s)</u>
1	6.000	1.194	6646
2	6.000	1.193	6640
3	6.001	1.197	6732
4	6.000	1.198	6706
5	6.001	1.198	6734
6	6.000	1.198	6741
7	6.001	1.198	6717
8	6.000	1.198	6738
9	6.000	1.198	6724

**Average velocity of increments 1-9:** 6709 m/s

DETONATION VELOCITY DATA

**Material:** RDX (GMX-3, jar milled)

**Experimenter:** M. J. Urizar      **Date:** December 9, 1953

**Shot no.:** GMX-2-098-2; GMX-8-D-4310

**Diameter:** 4 in.      **Average density:** 1.200 g/cm<sup>3</sup>      **Voids:** 34%

**Fabrication:** Pressed into brass      **Confinement:** 1-in. wall with 6-in.-o.d. brass

**Booster:** 1E15 detonator, P-040 lens, and Comp B

<u>Increment no.</u>	<u>Length (in.)</u>	<u>Density (g/cm<sup>3</sup>)</u>	<u>Velocity (m/s)</u>
1	4.000	1.200	--
2	4.000	1.200	6654
3	4.000	1.200	6660
4	4.000	1.200	6677
5	4.000	1.200	6641

**Average velocity of increments 2-5:** 6658 m/s

**DETONATION VELOCITY DATA**

**Material:** RDX (GMX-3, jar milled)

**Experimenter:** M. J. Urizar      **Date:** November 18, 1953

**Shot no.:** GMX-2-098-1; GMX-8-D-4288

**Diameter:** 4 in.      **Average density:** 1.200 g/cm<sup>3</sup>      **Voids:** 34%

**Fabrication:** Pressed into brass      **Confinement:** 1-in. wall with 6-in.-o.d. brass

**Booster:** 1E15 detonator, P-040 lens, and Comp B

<u>Increment no.</u>	<u>Length (in.)</u>	<u>Density (g/cm<sup>3</sup>)</u>	<u>Velocity (m/s)</u>
1	2.000	1.200	---
2	4.000	1.200	--
3	4.000	1.200	6671
4	4.000	1.200	6699
5	4.000	1.200	6654
6	4.000	1.200	6650
7	4.000	1.200	6686
8	4.000	1.200	6678

**Average velocity of increments 3-8:** 6673 m/s

DETONATION VELOCITY DATA

**Material:** Hol-30-B RDX

**Experimenter:** M. J. Urizar      **Date:** February 7, 1956

**Shot no.:** GMX-2-880-E; GMX-8-B-3865

**Diameter:** 0.25 in.      **Average density:** 1.402 g/cm<sup>3</sup>      **Voids:** 15.4%

**Fabrication:** Pressed into tubes

**Booster:** 1E15 detonator

<u>Increment no.</u>	<u>Length (in.)</u>	<u>Density (g/cm<sup>3</sup>)</u>	<u>Velocity (m/s)</u>
1	2.000	1.404	7251
2	2.000	1.402	7240
3	2.000	1.402	7240
4	2.000	1.402	7239
5	2.000	1.399	7234

**Average velocity of increments 1-5:** 7241 m/s



DETONATION VELOCITY DATA

**Material:** Hol-30-B RDX

**Experimenter:** M. J. Urizar      **Date:** January 31, 1956

**Shot no.:** GMX-2-880-D; GMX-8-B-3866

**Diameter:** 0.768 in.      **Average density:** 1.403 g/cm<sup>3</sup>      **Voids:** 15.4%

**Fabrication:** Pressed into tubes

**Booster:** 1E15 detonator and Comp B

<u>Increment no.</u>	<u>Length (in.)</u>	<u>Density (g/cm<sup>3</sup>)</u>	<u>Velocity (m/s)</u>
1	3.001	1.399	7416
2	3.001	1.402	7419
3	3.001	1.403	7385
4	3.001	1.403	7404
5	3.000	1.404	7395
6	3.000	1.405	7418
7	3.001	1.405	7421
8	3.000	1.405	---
9	3.000	1.404	---

**Average velocity of increments 1-7:** 7408 m/s

DETONATION VELOCITY DATA

Material: Hol-30-B RDX

Experimenter: M. J. Urizar Date: January 26, 1956

Shot no.: GMX-2-880-C; GMX-8-B-3867

Diameter: 1.025 in. Average density: 1.401 g/cm<sup>3</sup> Voids: 22.7%

Fabrication: Pressed into tubes Confinement: 0.2-in. wall brass

Booster: 1E15 detonator and Comp B

<u>Increment no.</u>	<u>Length (in.)</u>	<u>Density (g/cm<sup>3</sup>)</u>	<u>Velocity (m/s)</u>
1	3.000	1.406	7357
2	3.000	1.403	7389
3	3.000	1.403	7418
4	3.000	1.400	7395
5	3.000	1.401	7491
6	3.000	1.399	7422
7	3.000	1.398	7357
8	3.000	1.401	7432
9	2.999	1.399	7382

Average velocity of increments 1-9: 7405 m/s

**DETONATION VELOCITY DATA**

**Material:** RDX

**Experimenter:** M. J. Urizar      **Date:** January 3, 1957

**Shot no.:** GMX-2-959-D; GMX-8-B-4129

**Diameter:** 1.5 in.      **Average density:** 1.404 g/cm<sup>3</sup>      **Voids:** 22.7%

**Fabrication:** Pressed and machined      **Unconfined**

**Booster:** 1E15 detonator and Comp B

<u>Increment no.</u>	<u>Length (in.)</u>	<u>Density (g/cm<sup>3</sup>)</u>	<u>Velocity (m/s)</u>
1	3.500	1.408	---
2	3.500	1.406	---
3	3.500	1.399	7413
4	3.501	1.404	7429
5	3.499	1.402	7418
6	3.500	1.402	7430
7	3.500	1.405	7432

**Average velocity of increments 3-7:** 7424 m/s

DETONATION VELOCITY DATA

Material: RDX

Experimenter: M. J. Urizar Date: January 3, 1957

Shot no.: GMX-2-959-C; GMX-8-B-4128

Diameter: 1.5 in. Average density: 1.404 g/cm<sup>3</sup> Voids: 22.7%

Fabrication: Pressed and machined Unconfined

Booster: 1E15 detonator and Comp B

<u>Increment no.</u>	<u>Length (in.)</u>	<u>Density (g/cm<sup>3</sup>)</u>	<u>Velocity (m/s)</u>
1	3.500	1.410	---
2	3.501	1.399	---
3	3.500	1.405	7425
4	3.500	1.404	7426
5	3.500	1.401	7416
6	3.500	1.405	7442
7	3.500	1.403	7426

Average velocity of increments 3-7: 7427 m/s

DETONATION VELOCITY DATA

**Material:** Hol-30-B RDX

**Experimenter:** M. J. Urizar      **Date:** January 26, 1956

**Shot no.:** GMX-2-880-B; GMX-8-B-3868

**Diameter:** 1.538 in.      **Average density:** 1.399 g/cm<sup>3</sup>      **Voids:** 22.7%

**Fabrication:** Pressed into tubes      **Confinement:** 0.2-in. wall brass

**Booster:** 1E15 detonator and Comp B

<u>Increment no.</u>	<u>Length (in.)</u>	<u>Density (g/cm<sup>3</sup>)</u>	<u>Velocity (m/s)</u>
1	3.001	1.392	---
2	3.000	1.396	7328
3	3.000	1.401	7423
4	3.001	1.401	7383
5	3.000	1.398	7407
6	3.000	1.402	7429
7	3.000	1.400	7429
8	3.000	1.399	7395
9	3.000	1.401	--

**Average velocity of increments 2-8:** 7399 m/s

DETONATION VELOCITY DATA

Material: Hol-30-B RDX

Experimenter: M. J. Urizar Date: January 19, 1956

Shot no.: GMX-2-880-A; GMX-8-B-3869

Diameter: 3.079 in. Average density: 1.396 g/cm<sup>3</sup> Voids: 22.7%

Confinement: 0.2-in. wall brass

Booster: 1E15 detonator and Comp B

<u>Increment no.</u>	<u>Length (in.)</u>	<u>Density (g/cm<sup>3</sup>)</u>	<u>Velocity (m/s)</u>
1	6.000	1.394	---
2	6.001	1.395	---
3	6.000	1.398	7403
4	6.000	1.396	7447
5	6.000	1.396	7431
6	6.000	1.396	7432
7	6.000	1.396	7413
8	6.000	1.396	7447
9	6.000	1.396	7427

Average velocity of increments 3-9: 7429 m/s

**DETONATION VELOCITY DATA**

**Material:** RDX

**Experimenter:** M. J. Urizar      **Date:** January 21, 1957

**Shot no.:** GMX-2-959-B; GMX-8-E-0315

**Diameter:** 5.750 in.      **Average density:** 1.401 g/cm<sup>3</sup>      **Voids:** 22.7%

**Fabrication:** Pressed and machined      **Unconfined**

**Booster:** 1E15 detonator and Comp B

<u>Increment no.</u>	<u>Length (in.)</u>	<u>Density (g/cm<sup>3</sup>)</u>	<u>Velocity (m/s)</u>
1	16.000	1.404	7422
2	3.501	1.401	7431
3	3.300	1.405	7406
4	3.700	1.400	7409
5	3.950	1.399	7411
6	3.800	1.400	7416

**Average velocity of increments 1-6:** 7416 m/s

DETONATION VELOCITY DATA

Material: RDX

Experimenter: M. J. Urizar Date: December 28, 1956

Shot no.: GMX-2-959-A; GMX-8-B-4122

Diameter: 5.750 in. Average density: 1.402 g/cm<sup>3</sup> Voids: 22.7%

Fabrication: Pressed and machined Unconfined

Booster: 1E15 detonator and Comp B

<u>Increment no.</u>	<u>Length (in.)</u>	<u>Density (g/cm<sup>3</sup>)</u>	<u>Velocity (m/s)</u>
1	3.700	1.395	---
2	3.501	1.407	---
3	3.601	1.395	---
4	3.700	1.408	---
5	3.400	1.408	---
6	3.700	1.405	---
7	3.700	1.401	7428
8	3.600	1.400	7418
9	3.501	1.404	7430
10	3.700	1.403	7440
11	3.700	1.400	7446

Average velocity of increments 7-11: 7432 m/s



**DETONATION VELOCITY DATA**

**Material:** NSJ-30B RDX

**Experimenter:** F. DuBois      **Date:** August 13, 1953

**Shot no.:** GMX-2-013A; GMX-8-FL-7231

**Diameter:** 0.2500 in.      **Average density:** 1.500 g/cm<sup>3</sup>

**Fabrication:** Pressed      **Confinement:** 0.0625-in. wall brass

**Booster:** 1E15 detonator and Comp B

<u>Increment no.</u>	<u>Length (in.)</u>	<u>Density (g/cm<sup>3</sup>)</u>	<u>Velocity (m/s)</u>
1	---	---	---
2	2.000	1.496	---
3	2.000	1.506	7617
4	2.000	1.497	7607

**Average velocity of increments 3 and 4:** 7612 m/s

DETONATION VELOCITY DATA

**Material:** NSJ-30B RDX

**Experimenter:** F. DuBois      **Date:** August 6, 1953

**Shot no.:** GMX-2-013; GMX-8-B-2659

**Diameter:** 0.25 in.      **Average density:** 1.503 g/cm<sup>3</sup>

**Fabrication:** Pressed      **Confinement:** 0.25-in. wall brass

**Booster:** 1E15 detonator

<u>Increment no.</u>	<u>Length (in.)</u>	<u>Density (g/cm<sup>3</sup>)</u>	<u>Velocity (m/s)</u>
1	2.000	1.509	---
2	2.000	1.504	7629
3	2.000	1.499	7606
4	2.000	1.498	7566

**Average velocity of increments 2-4:** 7600 m/s

**DETONATION VELOCITY DATA**

**Material:** NSJ-30B RDX

**Experimenter:** F. DuBois     **Date:** August 21, 1953

**Shot no.:** GMX-2-013-A; GMX-8-FL-7249

**Diameter:** 1 in.     **Average density:** 1.500 g/cm<sup>3</sup>

**Fabrication:** Pressed     **Confinement:** 0.25-in. wall brass

**Booster:** 1E15 detonator and Comp B

<u>Increment no.</u>	<u>Length (in.)</u>	<u>Density (g/cm<sup>3</sup>)</u>	<u>Velocity (m/s)</u>
1	2.000	1.500	---
2	2.000	1.500	---
3	2.000	1.500	7602
4	2.000	1.500	7741

**Average velocity of increments 3 and 4:** 7672 m/s

DETONATION VELOCITY DATA

Material: NSJ-30B RDX

Experimenter: F. DuBois Date: August 21, 1953

Shot no.: GMX-2-013-B; GMX-8-FL-7250

Diameter: 1.0 in. Average density: 1.500 g/cm<sup>3</sup>

Fabrication: Pressed Confinement: 0.5-in. wall brass

Booster: 1E15 detonator

<u>Increment no.</u>	<u>Length (in.)</u>	<u>Density (g/cm<sup>3</sup>)</u>	<u>Velocity (m/s)</u>
1	2.000	1.500	---
2	2.000	1.500	7597
3	2.000	1.500	7651
4	2.000	1.500	7684

Average velocity of increments 2-4: 7644 m/s

DETONATION VELOCITY DATA

**Material:** RDX

**Experimenter:** K. Fess     **Date:** September 30, 1952

**Shot no.:** GMX-2-11515; GMX-8-FL-6348

**Diameter:** 2 in.     **Average density:** 1.6636 g/cm<sup>3</sup>     **Voids:** 8.2%

**Booster:** 1E15 detonator and P-040 lens

<u>Increment no.</u>	<u>Length (in.)</u>	<u>Density (g/cm<sup>3</sup>)</u>	<u>Velocity (m/s)</u>
1	1.051	1.6715	---
2	1.052	1.6611	7983
3	1.052	1.6610	8084
4	1.0515	1.6606	8224

**Average velocity of increments 2-4:** 8097 m/s

DETONATION VELOCITY DATA

Material: NSJ-30-B RDX

Experimenter: K. Fess Date: September 30, 1952

Shot no.: GMX-2-11530; GMX-8-FL-6349

Diameter: 2 in. Average density: 1.6647 g/cm<sup>3</sup> Voids: 8.2%

Booster: 1E15 detonator and P-040 lens

Increment no.	Length (in.)	Density (g/cm <sup>3</sup> )	Velocity (m/s)
1	1.052	1.6631	8355
2	1.052	1.6636	8068
3	1.0515	1.6637	8249
4	1.0515	1.6638	8282
5	1.0515	1.6639	8365
6	1.052	1.6639	8259
7	1.0515	1.6641	8209
8	1.0515	1.6649	8212
9	1.052	1.6650	8209
10	1.052	1.6653	8290
11	1.052	1.6656	8455
12	1.052	1.6657	8141
13	1.051	1.6657	8317
14	1.0515	1.6658	8385
15	1.051	1.6660	8171

Average velocity of increments 1-15: 8264 m/s

DETONATION VELOCITY DATA

**Material:** RDX

**Experimenter:** M. J. Urizar      **Date:** February 12, 1954

**Shot no.:** GMX-2-126; GMX-8-FL-7641

**Diameter:** 5.875 in.      **Average density:** 1.753 g/cm<sup>3</sup>      **Voids:** 3.3%

**Fabrication:** Vacuum pressed in 6-in. mold      **Unconfined**

**Booster:** 1E15 detonator and Comp B

<u>Increment no.</u>	<u>Length (in.)</u>	<u>Density (g/cm<sup>3</sup>)</u>	<u>Velocity (m/s)</u>
1	3.064	1.714	---
2	2.760	1.728	---
3	2.760	1.767	8604
4	2.877	1.761	8632
5	3.106	1.758	8548
6	3.107	1.754	8616
7	2.718	1.770	8578
8	2.759	1.774	8609

**Average velocity of increments 3-8:** 8598 m/s

DETONATION VELOCITY DATA

**Material:** Wabash RDX

**Experimenter:** M. J. Urizar      **Date:** January 23, 1951

**Shot no.:** GMX-2-686, -687, -688; GMX-8-D-1848

**Diameter:** 1.5 in.      **Average density:** 1.7659 g/cm<sup>3</sup>

**Booster:** 1E15 detonator and P-015 lens

<u>Increment no.</u>	<u>Length (in.)</u>	<u>Density (g/cm<sup>3</sup>)</u>	<u>Velocity (m/s)</u>
1	2.001	1.7711	8633
2	2.000	1.7642	8635
3	1.999	1.7625	8609

**Average velocity of increments 1-3:** 8626 m/s



**DETONATION VELOCITY DATA**

**Material:** 28 wt% RDX/42 wt% ammonium perchlorate/30 wt% Kel-F

**Experimenter:** J. B. Panowski      **Date:** April 21, 1954

**Shot no.:** GMX-2-247-B; GMX-8-B-3144

**Diameter:** 1.625 in.      **Average density:** 1.881 g/cm<sup>3</sup>

**Booster:** 1E15 detonator and Comp B

<u>Increment no.</u>	<u>Length (in.)</u>	<u>Density (g/cm<sup>3</sup>)</u>	<u>Velocity (m/s)</u>
1	3.500	1.880	--
2	4.000	1.882	6010
3	4.000	1.880	6010
4	4.000	1.880	5991

**Average velocity of increments 2-4:** 6004 m/s

DETONATION VELOCITY DATA

**Material:** 28 wt% RDX/42 wt% ammonium perchlorate/30 wt% Kel-F

**Experimenter:** J. B. Panowski      **Date:** April 21, 1954

**Shot no.:** GMX-2-247-A; GMX-8-B-3143

**Diameter:** 1.625 in.      **Average density:** 1.882 g/cm<sup>3</sup>

**Booster:** 1E15 detonator and Comp B

<u>Increment no.</u>	<u>Length (in.)</u>	<u>Density (g/cm<sup>3</sup>)</u>	<u>Velocity (m/s)</u>
1	3.250	1.876	--
2	4.000	1.885	6029
3	4.000	1.883	5988
4	4.000	1.882	6025

**Average velocity of increments 2-4:** 6014 m/s

DETONATION VELOCITY DATA

**Material:** 13.7 wt% RDX/43.3 wt% ammonium perchlorate/43 wt% Kel-F

**Experimenter:** J. B. Panowski      **Date:** April 9, 1954

**Shot no.:** GMX-2-2139 15-D; GMX-8-B-3126

**Diameter:** ~6 in.      **Average density:** 1.947 g/cm<sup>3</sup>      **Voids:** 0.4%

**Booster:** P-080 lens and 0.25-in.-long Comp B

<u>Increment no.</u>	<u>Length (in.)</u>	<u>Density (g/cm<sup>3</sup>)</u>	<u>Velocity (m/s)</u>
1	3.860	1.947	5092

**Material:** 19 wt% RDX/56 wt% barium chromate/25 wt% plastic

**Experimenter:** M. J. Urizar      **Date:** June 4, 1951

**Shot no.:** GMX-2-1957, -58, -59; GMX-8-FL-4489

**Diameter:** 3 in.      **Average density:** 2.8272 g/cm<sup>3</sup>

**Booster:** P-040 plane wave lens

<u>Increment no.</u>	<u>Length (in.)</u>	<u>Density (g/cm<sup>3</sup>)</u>	<u>Velocity (m/s)</u>
1	3.048	2.8367	4151
2	3.045	2.8311	4053
3	3.045	2.8138	3962

**Average velocity of increments 1-3:** 4055 m/s

DETONATION VELOCITY DATA

**Material:** 19 wt% RDX/56 wt% barium chromate/25 wt% plastic

**Experimenter:** M. J. Urizar      **Date:** June 4, 1951

**Shot no.:** GMX-2-1954, -55, -56; GMX-8-FL-4490

**Average density:** 2.8403 g/cm<sup>3</sup>

**Booster:** P-040 plane wave lens with Comp B pad

<u>Increment no.</u>	<u>Length (in.)</u>	<u>Density (g/cm<sup>3</sup>)</u>	<u>Velocity (m/s)</u>
1	3.037	2.8528	4323
2	3.045	2.8387	3679
3	3.050	2.8295	4110

**Average velocity of increments 1-3:** 4037 m/s

**Material:** 20 wt% RDX/70 wt% boric acid/8 wt% PS/2 wt% DOP

**Experimenter:** J. B. Panowski      **Date:** September 3, 1952

**Shot no.:** GMX-2-49114107K; GMX-8-FL-6276

**Diameter:** 5.000 in.      **Average density:** 1.401 ± 0.002 g/cm<sup>3</sup>      **Voids:** 5.2%

**Booster:** 1E15 detonator, P-075 or P-080 lens, and 2-in.-long Comp B

<u>Increment no.</u>	<u>Velocity (m/s)</u>
1	---
2	5120
3	5120
4	5096
5	---
6	---

**Average velocity of increments 2-4:** 5112 m/s

**DETONATION VELOCITY DATA**

**Material:** 80 wt% RDX/20 wt% boric oxide

**Experimenter:** K. Fess     **Date:** November 20, 1952

**Shot no.:** GMX-2-12095; GMX-8-B-1929

**Diameter:** 0.5 in.     **Average density:** 1.5014 g/cm<sup>3</sup>     **Voids:** 17.1%

**Booster:** 1E15 detonator and P-040 lens

**Average velocity of increments 1 and 2:** 6850 m/s

**Material:** 80 wt% RDX/20 wt% boric oxide

**Experimenter:** K. Fess     **Date:** November 20, 1952

**Shot no.:** GMX-2-12071; GMX-8-B-1813

**Diameter:** 0.5 in.     **Average density:** 1.4989 g/cm<sup>3</sup>

**Booster:** P-040 lens

**Average velocity of increments 1-6:** 6870 m/s

**Material:** 80 wt% RDX/20 wt% boric oxide

**Experimenter:** K. Fess     **Date:** November 20, 1952

**Shot no.:** GMX-2-12069; GMX-8-B-1931

**Diameter:** 0.5 in.     **Average density:** 1.5033 g/cm<sup>3</sup>

**Booster:** 1E15 detonator and P-040 lens

**Average velocity of increments 1-10:** 6881 m/s

DETONATION VELOCITY DATA

Material: 60 wt% RDX/40 wt% boric oxide

Experimenter: K. Fess Date: September 24, 1952

Shot no.: GMX-2-11647; GMX-8-FL-6331

Diameter: 3 in. Average density: 1.324 g/cm<sup>3</sup> Voids: 26.92%

Booster: 1E15 detonator and P-040 lens

Increment no.	Length (in.)	Density (g/cm <sup>3</sup> )	Velocity (m/s)
1	0.498	1.322	---
2	0.497	1.322	---
3	0.499	1.320	---
4	0.499	1.320	---
5	0.498	1.323	---
6	0.497	1.319	---
7	0.499	1.322	---
8	0.499	1.322	5048
9	0.498	1.324	---
10	0.498	1.326	5036
11	0.500	1.325	---
12	0.498	1.325	5073
13	0.498	1.327	---
14	0.499	1.327	4986
15	0.498	1.330	---
16	0.499	1.326	---
17	0.498	1.329	---
18	0.498	1.329	5022

Average velocity of increments 8-18: 5033 m/s

DETONATION VELOCITY DATA

Material: 60 wt% RDX/40 wt% boric oxide

Experimenter: K. Fess Date: September 24, 1952

Shot no.: GMX-2-11608; GMX-8-FL-6332

Diameter: 3 in. Average density: 1.336 g/cm<sup>3</sup> Voids: 26.92%

Booster: 1E15 detonator and P-040 lens

Increment no.	Length (in.)	Density (g/cm <sup>3</sup> )	Velocity (m/s)
1	0.498	1.344	---
2	0.497	1.339	---
3	0.497	1.341	---
4	0.497	1.339	---
5	0.499	1.338	---
6	0.499	1.339	---
7	0.498	1.336	---
8	0.498	1.336	5158
9	0.498	1.336	---
10	0.498	1.334	5087
11	0.497	1.332	---
12	0.498	1.334	5053
13	0.498	1.335	---
14	0.498	1.335	5150
15	0.498	1.331	---
16	0.497	1.333	---
17	0.498	1.331	---
18	0.498	1.333	5099

Average velocity of increments 8-18: 5109 m/s

DETONATION VELOCITY DATA

**Material:** 60 wt% RDX/40 wt% boric oxide

**Experimenter:** K. Fess      **Date:** November 20, 1952

**Shot no.:** GMX-2-11733; GMX-8-FL-1812

**Diameter:** 0.5 in.      **Average density:** 1.5391 g/cm<sup>3</sup>

**Booster:** P-040 lens

**Average velocity of increments 1-4:** 5829 m/s

**Material:** 60 wt% RDX/40 wt% boric oxide

**Experimenter:** K. Fess      **Date:** November 20, 1952

**Shot no.:** GMX-2-11720; GMX-8-B-1811

**Diameter:** 0.5 in.      **Average density:** 1.5370 g/cm<sup>3</sup>

**Booster:** P-040 lens

**Average velocity of increments 1 and 2:** 5882 m/s

**Material:** 60 wt% RDX/40 wt% boric oxide

**Experimenter:** K. Fess      **Date:** November 20, 1952

**Shot no.:** GMX-2-11715; GMX-8-B-1814

**Diameter:** 0.5 in.      **Average density:** 1.5565 g/cm<sup>3</sup>

**Booster:** P-040 lens

**Average velocity of increments 1-8:** 6060 m/s



**DETONATION VELOCITY DATA**

**Material:** 60 wt% RDX/40 wt% boric oxide

**Experimenter:** K. Fess      **Date:** September 23, 1952

**Shot no.:** GMX-2-11595; GMX-8-FL-6329

**Diameter:** 3 in.      **Average density:** 1.654 g/cm<sup>3</sup>      **Voids:** 9.95%

**Booster:** 1E15 detonator and P-040 lens

<u>Increment no.</u>	<u>Length (in.)</u>	<u>Density (g/cm<sup>3</sup>)</u>	<u>Velocity (m/s)</u>
1	0.507	1.650	---
2	0.508	1.655	---
3	0.507	1.652	---
4	0.508	1.654	---
5	0.508	1.652	---
6	0.507	1.653	---
7	0.506	1.655	---
8	0.508	1.656	6353
9	0.507	1.657	--
10	0.505	1.655	6343
11	0.506	1.655	---
12	0.508	1.654	6472
13	0.508	1.653	---
14	0.506	1.653	---
15	0.510	1.651	---
16	0.507	1.652	6258

**Average velocity of increments 8-16:** 6357 m/s

DETONATION VELOCITY DATA

**Material:** 60 wt% RDX/40 wt% boric oxide

**Experimenter:** K. Fess      **Date:** September 23, 1952

**Shot no.:** GMX-2-11592; GMX-8-FL-6330

**Diameter:** 3 in.      **Average density:** 1.663 g/cm<sup>3</sup>      **Voids:** 9.95%

**Booster:** 1E15 detonator and P-040 lens

<u>Increment no.</u>	<u>Length (in.)</u>	<u>Density (g/cm<sup>3</sup>)</u>	<u>Velocity (m/s)</u>
1	0.505	1.658	---
2	0.509	1.663	---
3	0.506	1.659	---
4	0.504	1.666	---
5	0.508	1.658	---
6	0.508	1.653	---
7	0.504	1.664	---
8	0.505	1.659	6476
9	0.506	1.663	---
10	0.508	1.662	6206
11	0.506	1.666	---
12	0.506	1.666	6328
13	0.501	1.676	---
14	0.501	1.676	---
15	0.508	1.662	---
16	0.508	1.661	6308

**Average velocity of increments 8-16:** 6330 m/s

**DETONATION VELOCITY DATA**

**Material:** 90 wt% jar-milled RDX/10 wt% carbon (Norit)

**Experimenter:** F. DuBois      **Date:** August 6, 1953

**Shot no.:** GMX-2-007-B; GMX-8-FL-7161

**Diameter:** 1 in.      **Average density:** 1.446 g/cm<sup>3</sup>

**Fabrication:** Dry blend, pressed      **Confinement:** 0.5-in. wall brass

**Booster:** 1E15 detonator and Comp B

<u>Increment no.</u>	<u>Length (in.)</u>	<u>Density (g/cm<sup>3</sup>)</u>	<u>Velocity (m/s)</u>
1	2.0166	1.446	---
2	2.0173	1.446	7054
3	2.0163	1.446	7060
4	2.0170	1.446	7054

**Average velocity of increments 2-4:** 7056 m/s

DETONATION VELOCITY DATA

**Material:** 90 wt% jar-milled RDX/10 wt% carbon (Norit)

**Experimenter:** F. DuBois      **Date:** August 6, 1953

**Shot no.:** GMX-2-007-A; GMX-8-FL-7159

**Diameter:** 1 in.      **Average density:** 1.592 g/cm<sup>3</sup>

**Fabrication:** Dry blend, pressed      **Confinement:** 0.5-in. wall brass

**Booster:** 1E15 detonator and ~0.75-in.-long Comp B

<u>Increment no.</u>	<u>Length (in.)</u>	<u>Density (g/cm<sup>3</sup>)</u>	<u>Velocity (m/s)</u>
1	2.021	1.590	---
2	2.0198	1.592	7504
3	2.0171	1.592	7505
4	2.0183	1.592	7525

**Average velocity of increments 2-4:** 7511 m/s

**DETONATION VELOCITY DATA**

**Material:** 70 wt% Hol-E-74 RDX/30 wt% copper <44- $\mu$ m diam

**Experimenter:** F. DuBois      **Date:** May 4, 1953

**Shot no.:** GMX-2-13379; GMX-8-B-2408

**Diameter:** 1 in.      **Average density:** 1.776 g/cm<sup>3</sup>      **Voids:** 25.35%

**Fabrication:** Dry blend, pressed

**Booster:** 1E15 detonator, P-016 lens, and Comp B

<u>Increment no.</u>	<u>Length (in.)</u>	<u>Density (g/cm<sup>3</sup>)</u>	<u>Velocity (m/s)</u>
1	2.009	1.776	---
2	2.012	1.776	6425
3	2.010	1.776	6424
4	2.011	1.776	6419

**Average velocity of increments 2-4:** 6423 m/s

DETONATION VELOCITY DATA

**Material:** 70 wt% Hol-E-74 RDX/30 wt% copper <44- $\mu$ m diam

**Experimenter:** F. DuBois     **Date:** May 4, 1953

**Shot no.:** GMX-2-13380; GMX-8-B-2407

**Diameter:** 1 in.     **Average density:** 1.776 g/cm<sup>3</sup>     **Voids:** 25.35%

**Fabrication:** Dry blend, pressed

**Booster:** 1E15 detonator, P-016 lens, and Comp B

<u>Increment no.</u>	<u>Length (in.)</u>	<u>Density (g/cm<sup>3</sup>)</u>	<u>Velocity (m/s)</u>
1	2.0103	1.776	---
2	2.0097	1.776	6421
3	2.0087	1.776	6431
4	2.0119	1.776	6444

**Average velocity of increments 2-4:** 6432 m/s

DETONATION VELOCITY DATA

Material: 70 wt% Hol-E-74 RDX/30 wt% copper <44- $\mu$ m diam

Experimenter: F. DuBois Date: May 12, 1953

Shot no.: GMX-2-13384; GMX-8-B-2418

Diameter: 1 in. Average density: 2.000 g/cm<sup>3</sup> Voids: 15.93%

Booster: 1E15 detonator and Comp B

<u>Increment no.</u>	<u>Length (in.)</u>	<u>Density (g/cm<sup>3</sup>)</u>	<u>Velocity (m/s)</u>
1	---	2.000	---
2	2.0100	2.000	7169
3	2.0115	2.000	7174
4	2.0090	2.000	7165

Average velocity of increments 2-4: 7169 m/s

## DETONATION VELOCITY DATA

**Material:** 70 wt% Hol-E-74 RDX/30 wt% copper <44- $\mu$ m diam

**Experimenter:** F. DuBois      **Date:** May 12, 1953

**Shot no.:** GMX-2-13387; GMX-8-B-2419

**Diameter:** 1 in.      **Average density:** 2.229 g/cm<sup>3</sup>      **Voids:** 6.31%

**Fabrication:** Dry blend, pressed

**Booster:** 1E15 detonator and Comp B

<u>Increment no.</u>	<u>Length (in.)</u>	<u>Density (g/cm<sup>3</sup>)</u>	<u>Velocity (m/s)</u>
1	---	---	---
2	2.0160	2.229	7859
3	2.0160	2.229	7856
4	2.0160	2.229	7864
5	2.0150	2.229	7855

**Average velocity of increments 2-5:** 7859 m/s



**DETONATION VELOCITY DATA**

**Material:** 60 wt% Hol-E-74 RDX/40 wt% copper <44- $\mu$ m diam

**Experimenter:** F. DuBois      **Date:** April 30, 1953

**Shot no.:** GMX-2-13378; GMX-8-B-2409

**Diameter:** 1 in.      **Average density:** 1.987 g/cm<sup>3</sup>      **Voids:** 25.22%

**Fabrication:** Dry blend, pressed

**Booster:** 1E15 detonator, P-016 lens, and Comp B

<u>Increment no.</u>	<u>Length (in.)</u>	<u>Density (g/cm<sup>3</sup>)</u>	<u>Velocity (m/s)</u>
1	2.016	1.987	--
2	2.014	1.987	6113
3	2.016	1.987	6139
4	2.017	1.987	6069

**Average velocity of increments 2-4:** 6107 m/s

DETONATION VELOCITY DATA

**Material:** 60 wt% Hol-E-74 RDX/40 wt% copper <44- $\mu$ m diam

**Experimenter:** F. DuBois      **Date:** April 30, 1953

**Shot no.:** GMX-2-13377; GMX-8-B-2390

**Diameter:** 1 in.      **Average density:** 1.987 g/cm<sup>3</sup>      **Voids:** 25.22%

**Fabrication:** Dry blend, pressed

**Booster:** 1E15 detonator, P-016 lens, and Comp B

<u>Increment no.</u>	<u>Length (in.)</u>	<u>Density (g/cm<sup>3</sup>)</u>	<u>Velocity (m/s)</u>
1	2.017	1.987	---
2	2.015	1.987	---
3	2.016	1.987	6151
4	2.015	1.987	6158

**Average velocity of increments 3 and 4:** 6155 m/s

DETONATION VELOCITY DATA

**Material:** 60 wt% Hol-E-74 RDX/40 wt% copper <44- $\mu$ m diam

**Experimenter:** F. DuBois      **Date:** April 24, 1953

**Shot no.:** GMX-2-13369; GMX-8-B-2380

**Diameter:** 1 in.      **Average density:** 2.095 g/cm<sup>3</sup>      **Voids:** 21.16%

**Fabrication:** Dry blend, pressed

**Booster:** 1E15 detonator, P-016 lens, and Comp B

<u>Increment no.</u>	<u>Length (in.)</u>	<u>Density (g/cm<sup>3</sup>)</u>	<u>Velocity (m/s)</u>
1	2.0171	2.095	--
2	2.0165	2.095	6321
3	2.0183	2.095	6494
4	2.0183	2.095	6563

**Average velocity of increments 2-4:** 6459 m/s

DETONATION VELOCITY DATA

**Material:** 60 wt% Hol-E-74 RDX/40 wt% copper <44- $\mu$ m diam

**Experimenter:** F. DuBois     **Date:** April 24, 1953

**Shot no.:** GMX-2-13366; GMX-8-B-2378

**Diameter:** 1 in.     **Average density:** 2.095 g/cm<sup>3</sup>     **Voids:** 21.16%

**Fabrication:** Dry blend, pressed

**Booster:** 1E15 detonator, P-016 lens, and Comp B

<u>Increment no.</u>	<u>Length (in.)</u>	<u>Density (g/cm<sup>3</sup>)</u>	<u>Velocity (m/s)</u>
1	2.0173	2.095	---
2	2.0173	2.095	---
3	2.0195	2.095	6473
4	2.0204	2.095	6458

**Average velocity of increments 3 and 4:** 6466 m/s

**DETONATION VELOCITY DATA**

**Material:** 60 wt% Hol-E-74 RDX/40 wt% copper <44- $\mu$ m diam

**Experimenter:** F. DuBois      **Date:** April 24, 1953

**Shot no.:** GMX-2-13367; GMX-8-B-2379

**Diameter:** 1 in.      **Average density:** 2.095 g/cm<sup>3</sup>      **Voids:** 21.16%

**Fabrication:** Dry blend, pressed

**Booster:** 1E15 detonator, P-016 lens, and Comp B

<u>Increment no.</u>	<u>Length (in.)</u>	<u>Density (g/cm<sup>3</sup>)</u>	<u>Velocity (m/s)</u>
1	2.0193	2.095	—
2	2.0177	2.095	6470
3	2.0181	2.095	6482
4	2.0164	2.095	6472

**Average velocity of increments 2-4:** 6475 m/s

DETONATION VELOCITY DATA

**Material:** 60 wt% Hol-E-74 RDX/40 wt% copper <44- $\mu$ m diam

**Experimenter:** F. DuBois      **Date:** April 24, 1953

**Shot no.:** GMX-2-13368; GMX-8-B-2381

**Diameter:** 1 in.      **Average density:** 2.095 g/cm<sup>3</sup>      **Voids:** 21.16%

**Fabrication:** Dry blend, pressed

**Booster:** 1E15 detonator, P-016 lens, and Comp B

<u>Increment no.</u>	<u>Length (in.)</u>	<u>Density (g/cm<sup>3</sup>)</u>	<u>Velocity (m/s)</u>
1	2.0186	2.095	---
2	2.0177	2.095	6471
3	2.0170	2.095	6481
4	2.0202	2.095	6510

**Average velocity of increments 2-4:** 6487 m/s

**DETONATION VELOCITY DATA**

**Material:** 60 wt% Hol-E-74 RDX/40 wt% copper <44- $\mu$ m diam

**Experimenter:** F. DuBois      **Date:** April 30, 1953

**Shot no.:** GMX-2-13376; GMX-8-B-2403

**Diameter:** 1 in.      **Average density:** 2.228 g/cm<sup>3</sup>      **Voids:** 16.15%

**Fabrication:** Dry blend, pressed

**Booster:** 1E15 detonator, P-016 lens, and Comp B

<u>Increment no.</u>	<u>Length (in.)</u>	<u>Density (g/cm<sup>3</sup>)</u>	<u>Velocity (m/s)</u>
1	2.0181	2.228	---
2	2.0172	2.228	6910
3	2.0155	2.228	7057
4	2.0186	2.228	6807

**Average velocity of increments 2-4:** 6925 m/s

DETONATION VELOCITY DATA

**Material:** 60 wt% Hol-E-74 RDX/40 wt% copper <44- $\mu$ m diam

**Experimenter:** F. DuBois      **Date:** April 30, 1953

**Shot no.:** GMX-2-13375; GMX-8-B-2402

**Diameter:** 1 in.      **Average density:** 2.228 g/cm<sup>3</sup>      **Voids:** 16.15%

**Fabrication:** Dry blend, pressed

**Booster:** 1E15 detonator, P-016 lens, and Comp B

<u>Increment no.</u>	<u>Length (in.)</u>	<u>Density (g/cm<sup>3</sup>)</u>	<u>Velocity (m/s)</u>
1	2.0180	2.228	---
2	2.0167	2.228	6879
3	2.0179	2.228	6923
4	2.0183	2.228	7029

**Average velocity of increments 2-4:** 6944 m/s



DETONATION VELOCITY DATA

**Material:** 60 wt% Hol-E-74 RDX/40 wt% copper <44- $\mu$ m diam

**Experimenter:** F. DuBois     **Date:** April 30, 1953

**Shot no.:** GMX-2-13373; GMX-8-B-2399

**Diameter:** 1 in.     **Average density:** 2.381 g/cm<sup>3</sup>     **Voids:** 10.39%

**Fabrication:** Dry blend, pressed

**Booster:** 1E15 detonator, P-040 lens, and Comp B

<u>Increment no.</u>	<u>Length (in.)</u>	<u>Density (g/cm<sup>3</sup>)</u>	<u>Velocity (m/s)</u>
1	2.0185	2.381	--
2	2.0195	2.381	7312
3	2.0191	2.381	7307
4	2.0178	2.381	7340

**Average velocity of increments 2-4:** 7320 m/s

DETONATION VELOCITY DATA

**Material:** 60 wt% Hol-E-74 RDX/40 wt% copper <44- $\mu$ m diam

**Experimenter:** F. DuBois      **Date:** April 30, 1953

**Shot no.:** GMX-2-13374; GMX-8-B-2400

**Diameter:** 1 in.      **Average density:** 2.381 g/cm<sup>3</sup>      **Voids:** 10.39%

**Fabrication:** Dry blend, pressed

**Booster:** 1E15 detonator, P-040 lens, and Comp B

<u>Increment no.</u>	<u>Length (in.)</u>	<u>Density (g/cm<sup>3</sup>)</u>	<u>Velocity (m/s)</u>
1	2.0198	2.381	--
2	2.0184	2.381	--
3	2.0193	2.381	7489
4	2.0214	2.381	7321

**Average velocity of increments 3 and 4:** 7405 m/s

DETONATION VELOCITY DATA

**Material:** 60 wt% Hol-E-74 RDX/40 wt% copper <44- $\mu$ m diam

**Experimenter:** F. DuBois      **Date:** April 21, 1953

**Shot no.:** GMX-2-13365; GMX-8-B-2373

**Diameter:** 1 in.      **Average density:** 2.491 g/cm<sup>3</sup>      **Voids:** 6.25%

**Fabrication:** Dry blend, pressed

**Booster:** 1E15 detonator, P-016 lens, and Comp B

<u>Increment no.</u>	<u>Length (in.)</u>	<u>Density (g/cm<sup>3</sup>)</u>	<u>Velocity (m/s)</u>
1	2.0230	2.491	--
2	2.0201	2.491	7497
3	2.0261	2.491	7620
4	2.0206	2.491	7632

**Average velocity of increments 2-4:** 7583 m/s

DETONATION VELOCITY DATA

**Material:** 60 wt% Hol-E-74 RDX/40 wt% copper <44- $\mu$ m diam

**Experimenter:** F. DuBois      **Date:** April 21, 1953

**Shot no.:** GMX-2-13362; GMX-8-B-2372

**Diameter:** 1 in.      **Average density:** 2.491 g/cm<sup>3</sup>      **Voids:** 6.25%

**Fabrication:** Dry blend, pressed

**Booster:** 1E15 detonator, P-016 lens, and Comp B

<u>Increment no.</u>	<u>Length (in.)</u>	<u>Density (g/cm<sup>3</sup>)</u>	<u>Velocity (m/s)</u>
1	2.0244	2.491	---
2	2.0250	2.491	7610
3	2.0224	2.491	7626
4	2.0239	2.491	7605

**Average velocity of increments 2-4:** 7614 m/s

DETONATION VELOCITY DATA

**Material:** 60 wt% Hol-E-74 RDX/40 wt% copper <44- $\mu$ m diam

**Experimenter:** F. DuBois      **Date:** April 21, 1953

**Shot no.:** GMX-2-13363; GMX-8-B-2371

**Diameter:** 1 in.      **Average density:** 2.491 g/cm<sup>3</sup>      **Voids:** 6.25%

**Fabrication:** Dry blend, pressed

**Booster:** 1E15 detonator, P-016 lens, and Comp B

<u>Increment no.</u>	<u>Length (in.)</u>	<u>Density (g/cm<sup>3</sup>)</u>	<u>Velocity (m/s)</u>
1	2.0237	2.491	--
2	2.0214	2.491	7615
3	2.0243	2.491	7641
4	2.0245	2.491	7658

**Average velocity of increments 2-4:** 7638 m/s

DETONATION VELOCITY DATA

**Material:** 60 wt% Hol-E-74 RDX/40 wt% copper <44- $\mu$ m diam

**Experimenter:** F. DuBois      **Date:** April 21, 1953

**Shot no.:** GMX-2-13364; GMX-8-B-2374

**Diameter:** 1 in.      **Average density:** 2.491 g/cm<sup>3</sup>      **Voids:** 6.25%

**Fabrication:** Dry blend, pressed

**Booster:** 1E15 detonator, P-016 lens, and Comp B

<u>Increment no.</u>	<u>Length (in.)</u>	<u>Density (g/cm<sup>3</sup>)</u>	<u>Velocity (m/s)</u>
1	2.0224	2.491	--
2	2.0216	2.491	7796
3	2.0192	2.491	7536
4	2.0208	2.491	8008

**Average velocity of increments 2-4:** 7780 m/s

DETONATION VELOCITY DATA

**Material:** 90 wt% RDX/10 wt% DNPA

**Experimenter:** E. James, Jr     **Date:** May 14, 1954

**Shot no.:** GMX-2-223-K; GMX-8-B-3179

**Diameter:** 0.125 in.     **Average density:** 1.7479 g/cm<sup>3</sup>     **Voids:** ~1.0%

**Booster:** 1E15 detonator

<u>Increment no.</u>	<u>Length (in.)</u>	<u>Velocity (m/s)</u>
1	2.032	8333
2	2.032	8335
3	2.032	8323
4	2.032	8327
5	2.031	8348
6	2.031	8304
7	2.032	8322

**Average velocity of increments 1-7:** 8327 m/s

**Note:** Fired at 79°F

DETONATION VELOCITY DATA

**Material:** 90 wt% RDX/10 wt% DNPA

**Experimenter:** E. James, Jr.      **Date:** April 20, 1954

**Shot no.:** GMX-2-223-J; GMX-8-B-3140

**Diameter:** 0.143 in.      **Average density:** 1.7480 g/cm<sup>3</sup>      **Voids:** ~1.5%

**Booster:** 1E15 detonator

<u>Increment no.</u>	<u>Length (in.)</u>	<u>Velocity (m/s)</u>
1	2.032	8359
2	2.032	8355
3	2.031	8335
4	2.031	8349
5	2.031	8342
6	2.031	8347
7	2.032	8357
8	2.032	8356

**Average velocity of increments 1-8:** 8350 m/s



**DETONATION VELOCITY DATA**

**Material:** 90 wt% RDX/10 wt% DNPA

**Experimenter:** E. James, Jr.    **Date:** April 9, 1954

**Shot no.:** GMX-2-223-A; GMX-8-B-3139

**Diameter:** 0.167 in.    **Average density:** 1.7477 g/cm<sup>3</sup>    **Voids:** ~1.5%

**Booster:** 1E15 detonator

<u>Increment no.</u>	<u>Length (in.)</u>	<u>Velocity (m/s)</u>
1	---	---
2	---	---
3	2.032	8367
4	2.033	8372
5	2.032	8367
6	2.032	8364
7	2.032	8369
8	2.032	8363

**Average velocity of increments 3-8:** 8367 m/s

DETONATION VELOCITY DATA

Material: 90 wt% RDX/10 wt% DNPA

Experimenter: E. James, Jr. Date: April 9, 1954

Shot no.: GMX-2-223-B; GMX-8-B-3138

Diameter: 0.200 in. Average density: 1.7477 g/cm<sup>3</sup> Voids: 1.5%

Booster: 1E15 detonator

<u>Increment no.</u>	<u>Length (in.)</u>	<u>Velocity (m/s)</u>
1	---	---
2	---	---
3	2.032	8397
4	2.032	8392
5	2.032	8390
6	2.032	8390
7	2.032	8389
8	2.032	8388

Average velocity of increments 3-8: 8391 m/s

**DETONATION VELOCITY DATA**

**Material:** 90 wt% RDX/10 wt% DNPA

**Experimenter:** E. James, Jr.      **Date:** May 14, 1954

**Shot no.:** GMX-2-223-L; GMX-8-B-3178

**Diameter:** 0.250 in.      **Average density:** 1.7479 g/cm<sup>3</sup>      **Voids:** ~1.0%

**Booster:** 1E15 detonator

<u>Increment no.</u>	<u>Length (in.)</u>	<u>Velocity (m/s)</u>
1	---	---
2	---	---
3	2.032	8388
4	2.032	8407
5	2.032	8393
6	2.032	8393
7	2.032	8390
8	2.032	8398

**Average velocity of increments 3-8:** 8395 m/s

DETONATION VELOCITY DATA

Material: 90 wt% RDX/10 wt% DNPA

Experimenter: E. James, Jr. Date: April 9, 1954

Shot no.: GMX-2-223-C; GMX-8-B-3137

Diameter: 0.333 in. Average density: 1.7480 g/cm<sup>3</sup> Voids: ~1.5%

Booster: 1E15 detonator

<u>Increment no.</u>	<u>Length (in.)</u>	<u>Velocity (m/s)</u>
1	---	---
2	---	---
3	2.031	8408
4	2.032	8422
5	2.032	8416
6	2.032	8423
7	2.032	8410
8	2.032	8407

Average velocity of increments 3-8: 8414 m/s

DETONATION VELOCITY DATA

Material: 90 wt% RDX/10 wt% DNPA

Experimenter: E. James, Jr. Date: April 9, 1954

Shot no.: GMX-2-223-D; GMX-8-B-3136

Diameter: 0.5000 in. Average density: 1.7475 g/cm<sup>3</sup> Voids: ~1.5%

Booster: 1E15 detonator

<u>Increment no.</u>	<u>Length (in.)</u>	<u>Velocity (m/s)</u>
1	---	---
2	---	---
3	2.032	8475
4	2.032	8433
5	2.032	8416
6	2.032	8425
7	2.032	8418
8	2.032	8413

Average velocity of increments 3-8: 8430 m/s

DETONATION VELOCITY DATA

**Material:** 90 wt% RDX/10 wt% DNPA

**Experimenter:** E. James, Jr.    **Date:** April 9, 1954

**Shot no.:** GMX-2-223-E; GMX-8-B-3135

**Diameter:** 0.6450 in.    **Average density:** 1.7477 g/cm<sup>3</sup>    **Voids:** ~1.5%

**Booster:** 1E15 detonator

<u>Increment no.</u>	<u>Length (in.)</u>	<u>Velocity (m/s)</u>
1	---	---
2	---	---
3	2.032	8431
4	2.032	8429
5	2.032	8423
6	2.032	8434
7	2.031	8431
8	2.032	8436

**Average velocity of increments 3-8:** 8431 m/s

DETONATION VELOCITY DATA

**Material:** 90 wt% RDX/10 wt% DNPA

**Experimenter:** E. James, Jr.     **Date:** April 9, 1954

**Shot no.:** GMX-2-223-F; GMX-8-B-3134

**Diameter:** 0.9020 in.     **Average density:** 1.7477 g/cm<sup>3</sup>     **Voids:** ~1.5%

**Booster:** 1E15 detonator

<u>Increment no.</u>	<u>Length (in.)</u>	<u>Velocity (m/s)</u>
1	---	--
2	---	--
3	2.032	8444
4	2.031	8444
5	2.032	8442
6	2.032	8434
7	2.032	8423
8	2.032	8428

**Average velocity of increments 3-8:** 8436 m/s

DETONATION VELOCITY DATA

Material: 90 wt% RDX/10 wt% DNPA

Experimenter: E. James, Jr. Date: May 14, 1954

Shot no.: GMX-2-223-M; GMX-8-B-3176

Diameter: 1.000 in. Average density: 1.7479 g/cm<sup>3</sup> Voids: ~1.0

Booster: 1E15 detonator

<u>Increment no.</u>	<u>Length (in.)</u>	<u>Velocity (m/s)</u>
1	---	---
2	---	---
3	1.5242	8428
4	1.4941	8401
5	1.5245	8432
6	1.5247	8441
7	1.5242	8417
8	1.5240	8427
9	1.5247	8429

Average velocity of increments 3-9: 8425 m/s



**DETONATION VELOCITY DATA**

**Material:** 90 wt% RDX/10 wt% DNPA

**Experimenter:** E. James, Jr.      **Date:** April 9, 1954

**Shot no.:** GMX-2-223-G; GMX-8-B-3132

**Diameter:** 1.500 in.      **Average density:** 1.7475 g/cm<sup>3</sup>      **Voids:** ~1.5%

**Booster:** 1E15 detonator

<u>Increment no.</u>	<u>Length (in.)</u>	<u>Velocity (m/s)</u>
1	1.500	---
2	1.500	---
3	1.500	---
4	2.000	8432
5	2.000	8434
6	2.000	8426
7	2.000	8434
8	2.000	8432
9	2.000	8430

**Average velocity of increments 4-9:** 8431 m/s

DETONATION VELOCITY DATA

Material: 90 wt% RDX/10 wt% DNPA

Experimenter: E. James, Jr. Date: April 9, 1954

Shot no.: GMX-2-223-H; GMX-8-B-3141

Diameter: 1.5 in. Average density: 1.7475 g/cm<sup>3</sup> Voids: ~1.5%

Booster: 1E15 detonator

<u>Increment no.</u>	<u>Length (in.)</u>	<u>Velocity (m/s)</u>
1	2.000	8433
2	2.000	8430
3	2.000	8424
4	2.000	8433
5	2.000	8441
6	2.000	8431
7	2.000	8434
8	2.000	8432

Average velocity of increments 1-8: 8432 m/s

DETONATION VELOCITY DATA

Material: 88 wt% RDX/10 wt% p-DNPA/2 wt% b-DNPAd

Experimenter: E. James, Jr. Date: June 28, 1954

Shot no.: GMX-2-290-4-D; GMX-8-B-3238

Diameter: 0.333 in. Average density: 1.733 g/cm<sup>3</sup>

Booster: 1E15 detonator

<u>Increment no.</u>	<u>Length (in.)</u>	<u>Velocity (m/s)</u>
1	2.000	--
2	2.000	--
3	2.000	8318
4	2.000	8313
5	2.000	8321
6	2.000	8318
7	2.000	8316
8	2.000	8307

Average velocity of increments 3-8: 8316 m/s

DETONATION VELOCITY DATA

**Material:** 88 wt% RDX/10 wt% p-DNPA/2 wt% b-DNPAd

**Experimenter:** E. James, Jr.     **Date:** June 28, 1954

**Shot no.:** GMX-2-290-5-C; GMX-8-B-3237

**Diameter:** 0.500 in.     **Average density:** 1.733 g/cm<sup>3</sup>

**Booster:** 1E15 detonator

<u>Increment no.</u>	<u>Length (in.)</u>	<u>Velocity (m/s)</u>
1	2.000	---
2	2.000	---
3	2.000	8316
4	2.000	8329
5	2.000	8322
6	2.000	8323
7	2.000	8323
8	2.000	8330

**Average velocity of increments 3-8:** 8324 m/s

DETONATION VELOCITY DATA

**Material:** 88 wt% RDX/10 wt% p-DNPA/2 wt% b-DNPAd

**Experimenter:** E. James, Jr.      **Date:** June 28, 1954

**Shot no.:** GMX-2-290-4-B; GMX-8-B-3234

**Diameter:** 1 in.      **Average density:** 1.733 g/cm<sup>3</sup>

**Booster:** 1E15 detonator

<u>Increment no.</u>	<u>Length (in.)</u>	<u>Velocity (m/s)</u>
1	2.000	---
2	2.000	---
3	2.000	8339
4	2.000	8333
5	2.000	8332
6	2.000	8362
7	2.000	8337
8	2.000	8334

**Average velocity of increments 3-8:** 8340 m/s

DETONATION VELOCITY DATA

Material: 88 wt% RDX/10 wt% p-DNPA/2 wt% b-DNPA d

Experimenter: E. James, Jr. Date: June 28, 1954

Shot no.: GMX-2-290-5-A; GMX-8-B-3233

Diameter: 2.000 in. Average density: 1.733 g/cm<sup>3</sup>

Booster: 1E15 detonator

<u>Increment no.</u>	<u>Length (in.)</u>	<u>Velocity (m/s)</u>
1	2.000	---
2	2.000	---
3	2.000	8334
4	2.000	8342
5	2.000	8345
6	2.000	8344
7	2.000	8353
8	2.000	8319

Average velocity of increments 3-8: 8340 m/s

**DETONATION VELOCITY DATA**

**Material:** 85.6 wt% RDX/14.4 wt% DNPA

**Experimenters** M. J. Urizar      **Date:** December 7, 1951

**Shot no.:** GMX-2-4773 through -4778; GMX-8-FL-5431

**Diameter:** 1.5 in.      **Average density:** 1.6207 g/cm<sup>3</sup>      **Voids:** 7.60%

**Booster:** 1E15 detonator and P-015 lens

<u>Increment no.</u>	<u>Length (in.)</u>	<u>Density (g/cm<sup>3</sup>)</u>	<u>Velocity (m/s)</u>
1	1.021	1.6045	---
2	1.021	1.6276	7980
3	1.023	1.6211	---
4	1.021	1.6243	8024
5	1.021	1.6343	8029
6	1.020	1.6226	---

**Average velocity of increments 2-5:** 8011 m/s

DETONATION VELOCITY DATA

**Material:** 85.6 wt% RDX/14.4 wt% DNPA

**Experimenters:** M. J. Urizar      **Date:** December 7, 1951

**Shot no.:** GMX-2-4779 through -4784; GMX-8-FL-5431

**Diameter:** 1.5 in.      **Average density:** 1.6788 g/cm<sup>3</sup>      **Voids:** 4.28%

**Booster:** 1E15 detonator and P-015 lens

<u>Increment no.</u>	<u>Length (in.)</u>	<u>Density (g/cm<sup>3</sup>)</u>	<u>Velocity (m/s)</u>
1	1.018	1.6816	---
2	1.019	1.6799	8135
3	1.019	1.6799	--
4	1.021	1.6766	8238
5	1.021	1.6766	8503
6	1.020	1.6783	---

**Average velocity of increments 2-5:** 8292 m/s



**DETONATION VELOCITY DATA**

**Material:** 85.6 wt% RDX/14.4 wt% DNPA

**Experimenters:** M. J. Urizar      **Date:** December 10, 1951

**Shot no.:** GMX-2-4737, -4739, -4742, -4743, -4749; GMX-8-FL-5432

**Diameter:** 1.5 in.      **Average density:** 1.7004 g/cm<sup>3</sup>      **Voids:** 2.47%

**Booster:** 1E15 detonator and P-015 lens

<u>Increment no.</u>	<u>Length (in.)</u>	<u>Density (g/cm<sup>3</sup>)</u>	<u>Velocity (m/s)</u>
1	1.138	1.6593	---
2	1.096	1.7072	8310
3	1.102	1.7100	---
4	1.093	1.7119	8384
5	1.092	1.7135	---

**Average velocity of increments 2-4:** 8347 m/s

DETONATION VELOCITY DATA

**Material:** 85 wt% RDX/15 wt% DNPA

**Experimenter:** M. J. Urizar      **Date:** October 14, 1952

**Shot no.:** GMX-2-12086, -12164, -12166, -12167, -12170; GMX-8-FL-6422

**Diameter:** 0.5 in.      **Average density:** 1.651 g/cm<sup>3</sup>      **Voids:** ~4.7%

**Fabrication:** Cold pressed for 2 minutes

**Booster:** 1E15 detonator

<u>Increment no.</u>	<u>Length (in.)</u>	<u>Density (g/cm<sup>3</sup>)</u>	<u>Velocity (m/s)</u>
1	0.5175	1.654	---
2	0.5193	1.649	---
3	0.5189	1.653	7989
4	0.5217	1.650	---
5	0.5190	1.651	7962

**Average velocity of increments 3-5:** 7976 m/s

**DETONATION VELOCITY DATA**

**Material:** 85 wt% RDX/15 wt% DNPA

**Experimenter:** M. J. Urizar      **Date:** October 14, 1952

**Shot no.:** GMX-2-12081, -12082, -12084, -12172, -12173; GMX-8-FL-6421

**Diameter:** 0.5 in.      **Average density:** 1.652 g/cm<sup>3</sup>      **Voids:** ~4.7%

**Fabrication:** Cold pressed for 2 minutes

**Booster:** 1E15 detonator

<u>Increment no.</u>	<u>Length (in.)</u>	<u>Density (g/cm<sup>3</sup>)</u>	<u>Velocity (m/s)</u>
1	0.5197	1.655	---
2	0.5168	1.647	8021
3	0.5163	1.655	7723
4	0.5190	1.649	7987
5	0.5213	1.652	8380

**Average velocity of increments 2-5:** 8028 m/s

DETONATION VELOCITY DATA

**Material:** 85 wt% RDX/15 wt% DNPA

**Experimenter:** M. J. Urizar      **Date:** October 15, 1952

**Shot no.:** GMX-2-12181, -12183, -12187, -12188, -12190; GMX-8-FL-6424

**Diameter:** 1 in.      **Average density:** 1.655 g/cm<sup>3</sup>      **Voids:** ~4.7%

**Fabrication:** Cold pressed, 50 lb for 2 minutes

**Booster:** 1E15 detonator and P-016 lens

<u>Increment no.</u>	<u>Length (in.)</u>	<u>Density (g/cm<sup>3</sup>)</u>	<u>Velocity (m/s)</u>
1	1.020	1.657	---
2	1.019	1.652	7998
3	1.017	1.654	8026
4	1.017	1.655	8077
5	1.016	1.657	8046

**Average velocity of increments 2-5:** 8037 m/s

DETONATION VELOCITY DATA

**Material:** 80 wt% RDX/20 wt% DNPA (polymer and monomer,  $\rho = 1.44 \text{ g/cm}^3$ )

**Experimenter:** F. DuBois      **Date:** May 21, 1954

**Shot no.:** GMX-2-260; GMX-8-B-3180

**Diameter:** 1.595 in.      **Average density:**  $1.725 \text{ g/cm}^3$

**Fabrication:** Vacuum pressed, machined

**Booster:** 1E15 detonator and Comp B

<u>Increment no.</u>	<u>Length (in.)</u>	<u>Density (<math>\text{g/cm}^3</math>)</u>	<u>Velocity (m/s)</u>
1	3.875	1.717	--
2	3.875	1.726	8233
3	3.875	1.726	8245
4	3.875	1.727	8232
5	3.875	1.727	8243

**Average velocity of increments 2-5:** 8238 m/s

DETONATION VELOCITY DATA

**Material:** 90 wt% RDX/8 wt% DNPA/2 wt% diisooctyl adipate

**Experimenter:** E. James, Jr.      **Date:** April 7, 1954

**Shot no.:** GMX-2-221-5; GMX-8-B-3122

**Diameter:** 1.675 in.      **Average density:** 1.724 g/cm<sup>3</sup>      **Voids:** ~1.5%

**Booster:** 1E15 detonator

<u>Increment no.</u>	<u>Length (in.)</u>	<u>Density (g/cm<sup>3</sup>)</u>	<u>Velocity (m/s)</u>
1	4.000	---	--
2	4.000	1.724	8423
3	4.000	1.723	8429
4	4.000	1.724	8429

**Average velocity of increments 2-4:** 8427 m/s

DETONATION VELOCITY DATA

**Material:** 90 wt% RDX/8 wt% DNPA/2 wt% diisooctyl adipate

**Experimenter:** E. James, Jr.      **Date:** April 7, 1954

**Shot no.:** GMX-2-221-3; GMX-8-B-3121

**Diameter:** 1.675 in.      **Average density:** 1.724 g/cm<sup>3</sup>      **Voids:** ~1.5%

**Fabrication:** 110°C, vacuum pressed, 200 tons

**Booster:** 1E15 detonator

<u>Increment no.</u>	<u>Length (in.)</u>	<u>Density (g/cm<sup>3</sup>)</u>	<u>Velocity (m/s)</u>
1	4.000	---	--
2	4.000	1.723	8435
3	4.000	1.723	8434
4	4.000	1.725	8436

**Average velocity of increments 2-4:** 8435 m/s

DETONATION VELOCITY DATA

Material: 95 wt% RDX/5 wt% Exon

Experimenter: J. B. Panowski Date: August 3, 1954

Shot no.: GMX-2-332; GMX-8-B-3273

Diameter: 1.625 in. Average density: 1.787 g/cm<sup>3</sup> Voids: 0.8%

Booster: 1E15 detonator and Comp B

<u>Increment no.</u>	<u>Length (in.)</u>	<u>Density (g/cm<sup>3</sup>)</u>	<u>Velocity (m/s)</u>
1	3.000	1.787	---
2	3.000	1.787	8570
3	3.000	1.787	8575
4	3.000	1.787	8567
5	3.000	1.788	8570
6	3.000	1.787	8569
7	3.000	1.788	8580
8	3.000	1.788	8578

Average velocity of increments 2-8: 8573 m/s



DETONATION VELOCITY DATA

Material: 92 wt% RDX/8 wt% Exon

Experimenter: J. B. Panowski Date: July 13, 1954

Shot no.: GMX-2-320-4; GMX-8-B-3235

Diameter: 1.625 in. Average density: 1.785 g/cm<sup>3</sup> Voids: 0.83%

Booster: 1E15 detonator and Comp B

<u>Increment no.</u>	<u>Length (in.)</u>	<u>Density (g/cm<sup>3</sup>)</u>	<u>Velocity (m/s)</u>
1	4.000	1.783	---
2	4.000	1.785	8447
3	4.000	1.785	8453
4	4.000	1.784	8453
5	4.000	1.786	8446
6	4.000	1.785	8451
7	4.000	1.785	8449

Average velocity of increments 2-7: 8450 m/s

DETONATION VELOCITY DATA

**Material:** 90 wt% RDX/10 wt% Exon

**Experimenter:** J. B. Panowski     **Date:** August 3, 1954

**Shot no.:** GMX-2-333; GMX-8-B-3274

**Diameter:** 1.625 in.     **Average density:** 1.787 g/cm<sup>3</sup>     **Voids:** 0.73%

**Booster:** 1E15 detonator and Comp B

<u>Increment no.</u>	<u>Length (in.)</u>	<u>Density (g/cm<sup>3</sup>)</u>	<u>Velocity (m/s)</u>
1	3.000	1.786	---
2	2.996	1.787	8403
3	3.000	1.787	8414
4	3.000	1.787	8413
5	3.000	1.787	8402
6	3.000	1.787	8415
7	3.000	1.787	8408
8	3.000	1.787	8410

**Average velocity of increments 2-8:** 8409 m/s

**DETONATION VELOCITY DATA**

**Material:** 87.27 wt% RDX/12.73 wt% Exon 400-XR-61

**Experimenter:** J. B. Panowski      **Date:** June 28, 1954

**Shot no.:** GMX-2-296-A; GMX-8-B-3231

**Diameter:** 0.200 in.      **Average density:** 1.780 g/cm<sup>3</sup>      **Voids:** 1.00%

**Booster:** 1E15 detonator

<u>Increment no.</u>	<u>Length (in.)</u>	<u>Density (g/cm<sup>3</sup>)</u>	<u>Velocity (m/s)</u>
1	2.000	1.782	--
2	2.000	1.780	---
3	2.000	1.780	8261
4	2.000	1.780	8264
5	2.000	1.779	8254
6	2.000	1.779	8257
7	2.000	1.779	8248
8	2.000	1.779	8257

**Average velocity of increments 3-8:** 8257 m/s

DETONATION VELOCITY DATA

Material: 87.27 wt% RDX/12.73 wt% Exon 400-XR-61

Experimenter: J. B. Panowski Date: June 28, 1954

Shot no.: GMX-2-296-C; GMX-8-B-3230

Diameter: 0.250 in. Average density: 1.784 g/cm<sup>3</sup> Voids: 0.8%

Booster: 1E15 detonator

<u>Increment no.</u>	<u>Length (in.)</u>	<u>Density (g/cm<sup>3</sup>)</u>	<u>Velocity (m/s)</u>
1	2.000	1.782	---
2	2.000	1.784	---
3	2.000	1.784	8280
4	2.000	1.784	8289
5	2.000	1.784	8279
6	2.000	1.784	8289
7	2.000	1.784	8280
8	2.000	1.784	8285

Average velocity of increments 3-8: 8284 m/s

DETONATION VELOCITY DATA

**Material:** 87.27 wt% RDX/12.73 wt% Exon 400-XR-61

**Experimenter:** J. B. Panowski      **Date:** June 28, 1954

**Shot no.:** GMX-2-296-B; GMX-8-B-3229

**Diameter:** 0.333 in.      **Average density:** 1.784 g/cm<sup>3</sup>      **Voids:** 0.8%

**Booster:** 1E15 detonator

<u>Increment no.</u>	<u>Length (in.)</u>	<u>Density (g/cm<sup>3</sup>)</u>	<u>Velocity (m/s)</u>
1	2.000	1.782	---
2	2.000	1.783	---
3	2.000	1.784	8288
4	2.000	1.784	8291
5	2.000	1.784	8300
6	2.000	1.784	8304
7	2.000	1.784	8295
8	2.000	1.784	8297

**Average velocity of increments 3-8:** 8296 m/s

DETONATION VELOCITY DATA

Material: 87.27 wt% RDX/12.73 wt% Exon 400-XR-61

Experimenter: J. B. Panowski Date: June 28, 1954

Shot no.: GMX-2-296-D; GMX-8-B-3226

Diameter: 0.500 in. Average density: 1.785 g/cm<sup>3</sup> Voids: 0.8%

Booster: 1E15 detonator

Increment no.	Length (in.)	Density (g/cm <sup>3</sup> )	Velocity (m/s)
1	2.000	1.786	---
2	2.000	1.783	---
3	2.000	1.785	8298
4	2.000	1.785	8298
5	2.000	1.784	8295
6	2.000	1.785	8305
7	2.000	1.784	8295
8	2.000	1.785	8305

Average velocity of increments 3-8: 8299 m/s

DETONATION VELOCITY DATA

Material: 87.27 wt% RDX/12.73 wt% Exon 400-XR-61

Experimenter: J. B. Panowski Date: June 28, 1954

Shot no.: GMX-2-296-E; GMX-8-B-3225

Diameter: 1.000 in. Average density: 1.784 g/cm<sup>3</sup> Voids: 0.8%

Booster: 1E15 detonator

<u>Increment no.</u>	<u>Length (in.)</u>	<u>Density (g/cm<sup>3</sup>)</u>	<u>Velocity (m/s)</u>
1	2.000	1.783	---
2	2.000	1.786	---
3	2.000	1.784	8306
4	2.000	1.784	8287
5	2.000	1.784	8310
6	2.000	1.784	8297
7	2.000	1.784	8299
8	2.000	1.784	8299

Average velocity of increments 3-8: 8300 m/s

DETONATION VELOCITY DATA

Material: 87.27 wt% RDX/12.73 wt% Exon 400-XR-61

Experimenter: J. B. Panowski Date: June 28, 1954

Shot no.: GMX-2-296-F; GMX-8-B-3224

Diameter: 1.625 in. Average density: 1.784 g/cm<sup>3</sup> Voids: 0.8%

Booster: 1E15 detonator and Comp B

<u>Increment no.</u>	<u>Length (in.)</u>	<u>Density (g/cm<sup>3</sup>)</u>	<u>Velocity (m/s)</u>
1	1.9375	1.784	---
2	1.9375	1.784	---
3	2.0000	1.784	8308
4	2.0000	1.784	8311
5	2.0000	1.784	8314
6	2.0000	1.784	8308
7	1.9375	1.785	8305

Average velocity of increments 3-7: 8309 m/s



**DETONATION VELOCITY DATA**

**Material:** 87.27 wt% RDX/12.73 wt% Exon 400-XR-61

**Experimenter:** J. B. Panowski      **Date:** June 28, 1954

**Shot no.:** GMX-2-296-G; GMX-8-B-3223

**Diameter:** 1.625 in.      **Average density:** 1.784 g/cm<sup>3</sup>      **Voids:** 0.8%

**Booster:** 1E15 detonator and Comp B

<u>Increment no.</u>	<u>Length (in.)</u>	<u>Density (g/cm<sup>3</sup>)</u>	<u>Velocity (m/s)</u>
1	2.000	1.785	---
2	2.000	1.785	---
3	1.9375	1.785	8311
4	1.9375	1.784	8318
5	1.9375	1.784	8308
6	1.9365	1.784	8311
7	2.000	1.784	8300

**Average velocity of increments 3-7:** 8310 m/s

## DETONATION VELOCITY DATA

**Material:** 85 wt% RDX/15 wt% Exon

**Experimenter:** J. B. Panowski      **Date:** August 3, 1954

**Shot no.:** GMX-2-334; GMX-8-B-3272

**Diameter:** 1.625 in.      **Average density:** 1.780 g/cm<sup>3</sup>      **Voids:** 0.95%

**Booster:** 1E15 detonator

<u>Increment no.</u>	<u>Length (in.)</u>	<u>Density (g/cm<sup>3</sup>)</u>	<u>Velocity (m/s)</u>
1	3.000	1.780	--
2	3.000	1.778	8211
3	3.000	1.779	8216
4	3.000	1.780	8220
5	3.000	1.780	8225
6	3.000	1.781	8220
7	3.000	1.781	8220
8	3.000	1.780	8216

**Average velocity of increments 2-8:** 8218 m/s

DETONATION VELOCITY DATA

Material: 80 wt% RDX/20 wt% Exon

Experimenter: J. B. Panowski Date: August 3, 1954

Shot no.: GMX-2-335; GMX-8-B-3271

Diameter: 1.625 in. Average density: 1.777 g/cm<sup>3</sup> Voids: 1.01%

Booster: 1E15 detonator and Comp B

Increment no.	Length (in.)	Density (g/cm <sup>3</sup> )	Velocity (m/s)
1	3.000	1.776	--
2	3.000	1.778	8039
3	3.000	1.777	8041
4	3.000	1.778	8041
5	3.000	1.776	8043
6	3.000	1.777	8043
7	3.000	1.777	8040
8	3.000	1.777	8039

Average velocity of increments 2-8: 8041 m/s

DETONATION VELOCITY DATA

Material: 75 wt% RDX/25 wt% Exon

Experimenter: J. B. Panowski Date: August 3, 1954

Shot no.: GMX-2-336; GMX-8-B-3270

Diameter: 1.625 in. Average density: 1.770 g/cm<sup>3</sup> Voids: 1.26%

Booster: 1E15 detonator and Comp B

<u>Increment no.</u>	<u>Length (in.)</u>	<u>Density (g/cm<sup>3</sup>)</u>	<u>Velocity (m/s)</u>
1	3.000	1.770	---
2	3.000	1.770	7875
3	3.000	1.770	7867
4	3.000	1.771	7867
5	3.000	1.770	7866
6	3.000	1.770	7871
7	3.000	1.770	7868
8	2.998	1.770	7875

Average velocity of increments 2-8: 7870 m/s

DETONATION VELOCITY DATA

**Material:** 51.93 wt% RDX/7.24 wt% Exon 400-XR-61/40.83 wt% lead

**Experimenter:** M. J. Urizar      **Date:** March 6, 1956

**Shot no.:** GMX-2-917-B; GMX-8-B-3876

**Diameter:** 1.625 in.      **Average density:** 2.702 g/cm<sup>3</sup>      **Voids:** 2%

**Fabrication:** Machined from 6-in. charges

**Booster:** 1E15 detonator and Comp B

<u>Increment no.</u>	<u>Length (in.)</u>	<u>Density (g/cm<sup>3</sup>)</u>	<u>Velocity (m/s)</u>
1	3.001	2.698	6742
2	3.001	2.700	6735
3	3.001	2.704	6737
4	3.001	2.700	6738
5	3.001	2.703	6735
6	3.001	2.705	6736
7	3.001	2.699	6741
8	3.001	2.704	6736
9	3.001	2.702	6752

**Average velocity of increments 1-9:** 6739 m/s

DETONATION VELOCITY DATA

**Material:** 51.93 wt% RDX/7.24 wt% Exon 400-XR-61/40.83 wt% lead

**Experimenter:** M. J. Urizar      **Date:** March 6, 1956

**Shot no.:** GMX-2-917-A; GMX-8-B-3877

**Diameter:** 3 in.      **Average density:** 2.701 g/cm<sup>3</sup>      **Voids:** 2%

**Fabrication:** Machined from 6-in. charges      **Unconfined**

**Booster:** 1E15 detonator and Comp B

<u>Increment no.</u>	<u>Length (in.)</u>	<u>Density (g/cm<sup>3</sup>)</u>	<u>Velocity (m/s)</u>
1	4.000	2.697	6734
2	4.000	2.702	6735
3	4.000	2.700	6733
4	4.000	2.704	6733
5	4.000	2.701	6734
6	4.000	2.703	6731
7	4.000	2.703	6731
8	4.000	2.700	6730
9	4.000	2.703	6730

**Average velocity of increments 1-9:** 6732 m/s

DETONATION VELOCITY DATA

**Material:** 33.82 wt% RDX/5.29 wt% Exon 400-XR-61/60.89 wt% lead

**Experimenter:** M. J. Urizar      **Date:** February 29, 1956

**Shot no.:** GMX-2-916-B; GMX-8-B-3874

**Diameter:** 1.625 in.      **Average density:** 3.648 g/cm<sup>3</sup>      **Voids:** 1.6%

**Fabrication:** Machined from 6-in. charges      **Unconfined**

**Booster:** 1E15 detonator and Comp B

<u>Increment no.</u>	<u>Length (in.)</u>	<u>Density (g/cm<sup>3</sup>)</u>	<u>Velocity (m/s)</u>
1	3.001	3.642	5721
2	3.000	3.654	5717
3	3.001	3.648	5721
4	3.001	3.651	5721
5	3.000	3.648	5717
6	3.001	3.648	5718
7	3.001	3.646	5716
8	3.001	3.653	5719
9	3.000	3.646	5719

**Average velocity of increments 1-9:** 5719 m/s

DETONATION VELOCITY DATA

**Material:** 33.82 wt% RDX/5.29 wt% Exon 400-XR-61/60.89 wt% lead

**Experimenter:** M. J. Urizar      **Date:** February 29, 1956

**Shot no.:** GMX-2-916-A; GMX-8-B-3875

**Diameter:** 3 in.      **Average density:** 3.644 g/cm<sup>3</sup>      **Voids:** 1.6%

**Fabrication:** Machined from 6-in. charges      **Unconfined**

**Booster:** 1E15 detonator and Comp B

<u>Increment no.</u>	<u>Length (in.)</u>	<u>Density (g/cm<sup>3</sup>)</u>	<u>Velocity (m/s)</u>
1	4.001	3.661	5711
2	4.001	3.660	5713
3	4.000	3.657	5715
4	4.000	3.646	5718
5	4.001	3.644	5716
6	4.000	3.646	5716
7	4.001	3.640	5716
8	4.001	3.644	5717
9	4.000	3.644	5711

**Average velocity of increments 1-9:** 5715 m/s



**DETONATION VELOCITY DATA**

**Material:** 23.23 wt% RDX/3.78 wt% Exon 400-XR-61/72.99 wt% lead

**Experimenter:** M. J. Urizar      **Date:** February 24, 1956

**Shot no.:** GMX-2-915-A; GMX-8-B-3872

**Diameter:** 3 in.      **Average density:** 4.601 g/cm<sup>3</sup>      **Voids:** 1.4%

**Fabrication:** Machined from 6-in. charges      **Unconfined**

**Booster:** 1E15 detonator and Comp B

<u>Increment no.</u>	<u>Length (in.)</u>	<u>Density (g/cm<sup>3</sup>)</u>	<u>Velocity (m/s)</u>
1	4.001	4.608	5014
2	4.001	4.603	5013
3	4.000	4.596	5013
4	4.000	4.599	5012
5	4.000	4.601	5012
6	4.001	4.598	5011
7	4.001	4.599	5010
8	4.001	4.600	5010
9	4.001	4.602	5011

**Average velocity of increments 1-9:** 5012 m/s

## DETONATION VELOCITY DATA

**Material:** 23.23 wt% RDX/3.78 wt% Exon 400-XR-61/72.99 wt% lead

**Experimenter:** M. J. Urizar      **Date:** February 24, 1956

**Shot no.:** GMX-2-915-B; GMX-8-B-3871

**Diameter:** 1.625 in.      **Average density:** 4.603 g/cm<sup>3</sup>      **Voids:** 1.4%

**Fabrication:** Machined from 6-in. charges      **Unconfined**

**Booster:** 1E15 detonator and Comp B

<u>Increment no.</u>	<u>Length (in.)</u>	<u>Density (g/cm<sup>3</sup>)</u>	<u>Velocity (m/s)</u>
1	3.001	4.605	5022
2	3.001	4.603	5015
3	3.001	4.604	5016
4	3.001	4.603	5025
5	3.001	4.603	5017
6	3.001	4.603	5024
7	3.001	4.599	5025
8	3.001	4.600	5001
9	3.001	4.603	5023

**Average velocity of increments 1-9:** 5019 m/s

DETONATION VELOCITY DATA

Material: 90 wt% RDX/10 wt% Kel-F

Experimenter: F. DuBois Date: October 27, 1953

Shot no.: GMX-2-76A; GMX-8-B-2831

Diameter: 1 in. Average density: 1.653 g/cm<sup>3</sup> Voids: 9.8%

Fabrication: Cold pressed

Booster: 1E15 detonator and Comp B

<u>Increment no.</u>	<u>Length (in.)</u>	<u>Density (g/cm<sup>3</sup>)</u>	<u>Velocity (m/s)</u>
1	1.048	1.655	---
2	} 2.094	1.652	---
3		1.652	7880
4	} 2.094	1.652	---
5		1.652	7901

Average velocity of increments 2-5: 7891 m/s

DETONATION VELOCITY DATA

Material: 90 wt% RDX/10 wt% Kel-F

Experimenter: F. DuBois Date: October 27, 1953

Shot no.: GMX-2-76-B; GMX-8-B-2832

Diameter: 1 in. Average density: 1.651 g/cm<sup>3</sup> Voids: 9.8%

Fabrication: Cold pressed

Booster: 1E15 detonator and Comp B

<u>Increment no.</u>	<u>Length (in.)</u>	<u>Density (g/cm<sup>3</sup>)</u>	<u>Velocity (m/s)</u>
1	1.049	1.649	---
2	} 2.094	1.652	---
3		1.652	7898
4	} 2.094	1.652	---
5		1.652	7892

Average velocity of increments 2-5: 7895 m/s

**DETONATION VELOCITY DATA**

**Material:** 90 wt% RDX/10 wt% Kel-F

**Experimenter:** F. DuBois     **Date:** March 11, 1954

**Shot no.:** GMX-2-199; GMX-8-B-3096

**Diameter:** 1.625 in.     **Average density:** 1.792 g/cm<sup>3</sup>     **Voids:** 2.2%

**Fabrication:** Vacuum pressed

**Booster:** 1E15 detonator and Comp B

<u>Increment no.</u>	<u>Length (in.)</u>	<u>Density (g/cm<sup>3</sup>)</u>	<u>Velocity (m/s)</u>
1	3	1.788	--
2	3	1.791	8396
3	3	1.791	8409
4	3	1.793	8410
5	3	1.792	8410
6	3	1.794	8403

**Average velocity of increments 2-6:** 8406 m/s

DETONATION VELOCITY DATA

Material: 86.88 wt% RDX/13.12 wt% Kel-F

Experimenter: J. B. Panowski Date: June 30, 1954

Shot no.: GMX-2-310-A; GMX-8-B-3253

Diameter: 1.675 in. Average density: 1.801 g/cm<sup>3</sup> Voids: ~0.5%

Booster: 1E15 detonator and P-016 lens

<u>Increment no.</u>	<u>Length (in.)</u>	<u>Density (g/cm<sup>3</sup>)</u>	<u>Velocity (m/s)</u>
1	4.000	1.801	---
2	2.000	1.801	8311
3	2.000	1.801	8310
4	2.000	1.801	8308
5	2.000	1.801	8310

Average velocity of increments 2-5: 8310 m/s

**DETONATION VELOCITY DATA**

**Material:** 86.88 wt% RDX/13.12 wt% Kel-F

**Experimenter:** J. B. Panowski      **Date:** June 30, 1954

**Shot no.:** GMX-2-310-B; GMX-8-B-3254

**Diameter:** 1.675 in.      **Average density:** 1.802 g/cm<sup>3</sup>      **Voids:** ~0.5%

**Booster:** 1E15 detonator and P-016 lens

<u>Increment no.</u>	<u>Length (in.)</u>	<u>Density (g/cm<sup>3</sup>)</u>	<u>Velocity (m/s)</u>
1	3.999	1.801	---
2	2.000	1.802	8323
3	2.000	1.802	8287
4	2.000	1.802	8300
5	2.000	1.802	8297

**Average velocity of increments 2-5:** 8302 m/s

DETONATION VELOCITY DATA

**Material:** 86 wt% RDX 492/14 wt% Kel-F

**Experimenter:** F. DuBois      **Date:** December 16, 1953

**Shot no.:** GMX-2-102-A; GMX-8-B-2930

**Diameter:** 1.625 in.      **Average density:** 1.804 g/cm<sup>3</sup>      **Voids:** 1.7%

**Fabrication:** Vacuum pressed

**Booster:** 1E15 detonator and PBX

<u>Increment no.</u>	<u>Length (in.)</u>	<u>Density (g/cm<sup>3</sup>)</u>	<u>Velocity (m/s)</u>
1	1.500	1.804	8234
2	1.500	1.804	8174

**Average velocity of increments 1 and 2:** 8204 m/s



**DETONATION VELOCITY DATA**

**Material:** 86 wt% RDX/14 wt% Kel-F

**Experimenter:** F. DuBois      **Date:** December 8, 1953

**Shot no.:** GMX-2-102; GMX-8-B-2925

**Diameter:** 1.625 in.      **Length:** 3.250 in.

**Average density:** 1.804 g/cm<sup>3</sup>      **Voids:** 1.75%

**Fabrication:** Vacuum pressed

**Booster:** 1E15 detonator

<u>Increment no.</u>	<u>Length (in.)</u>	<u>Density (g/cm<sup>3</sup>)</u>	<u>Velocity (m/s)</u>
1	3.250	1.805	--
2	3.250	1.804	8222
3	3.250	1.801	8275
4	3.250	1.805	8264
5	3.250	1.803	8264
6	3.250	1.803	8256

**Average velocity of increments 2-6:** 8256 m/s

DETONATION VELOCITY DATA

**Material:** 85 wt% RDX/15 wt% Kel-F

**Experimenter:** J. B. Panowski      **Date:** June 18, 1954

**Shot no.:** GMX-2-294-A; GMX-8-B-3217

**Diameter:** 0.333 in.      **Average density:** 1.818 g/cm<sup>3</sup>      **Voids:** 0.3%

**Booster:** 1E15 detonator

<u>Increment no.</u>	<u>Length (in.)</u>	<u>Density (g/cm<sup>3</sup>)</u>	<u>Velocity (m/s)</u>
1	2.000	1.819	---
2	2.000	1.817	---
3	2.000	1.818	8251
4	2.000	1.818	8253
5	2.000	1.818	8255
6	2.000	1.818	8263
7	2.000	1.818	8263
8	2.000	1.818	8280

**Average velocity of increments 3-8:** 8261 m/s

DETONATION VELOCITY DATA

**Material:** 85 wt% RDX/15 wt% Kel-F

**Experimenter:** J. B. Panowski      **Date:** June 18, 1954

**Shot no.:** GMX-2-294-B; GMX-8-B-3218

**Diameter:** 0.500 in.      **Average density:** 1.822 g/cm<sup>3</sup>      **Voids:** 0.3%

**Booster:** 1E15 detonator

<u>Increment no.</u>	<u>Length (in.)</u>	<u>Density (g/cm<sup>3</sup>)</u>	<u>Velocity (m/s)</u>
1	2.000	1.823	---
2	2.000	1.822	---
3	2.000	1.823	8306
4	2.000	1.822	8327
5	2.000	1.822	8304
6	2.000	1.820	8293
7	2.000	1.821	8296
8	2.000	1.820	8311

**Average velocity of increments 3-8:** 8306 m/s

DETONATION VELOCITY DATA

Material: 85 wt% RDX/15 wt% Kel-F

Experimenter: J. B. Panowski Date: June 18, 1954

Shot no.: GMX-2-294-C; GMX-8-B-3221

Diameter: 1.000 in. Average density: 1.823 g/cm<sup>3</sup> Voids: 0.3%

Booster: 1E15 detonator

<u>Increment no.</u>	<u>Length (in.)</u>	<u>Density (g/cm<sup>3</sup>)</u>	<u>Velocity (m/s)</u>
1	2.000	1.822	---
2	2.000	1.823	--
3	2.000	1.822	8300
4	2.000	1.823	8310
5	2.000	1.823	8311
6	2.000	1.822	8303
7	2.000	1.822	8304
8	2.000	1.823	8319

Average velocity of increments 3-8: 8308 m/s

DETONATION VELOCITY DATA

**Material:** 84.5 wt% RDX/15.5 wt% Kel-F

**Experimenter:** F. DuBois      **Date:** January 29, 1954

**Shot no.:** GMX-2-144; GMX-8-B-3044

**Diameter:** 1.625 in.      **Average density:** 1.82 g/cm<sup>3</sup>      **Voids:** 0.9%

**Booster:** 1E15 detonator

<u>Increment no.</u>	<u>Length (in.)</u>	<u>Density (g/cm<sup>3</sup>)</u>	<u>Velocity (m/s)</u>
1	---	---	---
2	4.000	1.820	8291
3	4.000	1.820	8310
4	4.000	1.820	8332
5	4.000	1.820	8325
6	4.000	1.820	8327

**Average velocity of increments 2-6:** 8317 m/s

DETONATION VELOCITY DATA

Material: 82.5 wt% RDX/17.5 wt% Kel-F

Experimenter: F. DuBois Date: November 4, 1953

Shot no.: GMX-2-76E; GMX-8-B-2863

Diameter: 1 in. Average density: 1.64 g/cm<sup>3</sup> Voids: 11%

Fabrication: Pressed

Booster: 1E15 detonator

<u>Increment no.</u>	<u>Length (in.)</u>	<u>Density (g/cm<sup>3</sup>)</u>	<u>Velocity (m/s)</u>
1	---	---	---
2	---	---	---
3	1.0148	1.639	---
4	1.0138	1.640	7649
5	1.0142	1.640	---
6	1.0141	1.640	7663
7	1.0142	1.640	---
8	1.0142	1.640	7670
9	1.0142	1.640	---
10	1.0141	1.640	---

Average velocity of increments 4-8: 7661 m/s

DETONATION VELOCITY DATA

**Material:** 80 wt% RDX/20 wt% Kel-F

**Experimenter:** F. DuBois    **Date:** March 5, 1954

**Shot no.:** GMX-2-201; GMX-8-B-3101

**Diameter:** 1.625 in.    **Average density:** 1.832 g/cm<sup>3</sup>    **Voids:** 0.8%

**Fabrication:** Vacuum pressed

**Booster:** 1E15 detonator and Comp B

<u>Increment no.</u>	<u>Length (in.)</u>	<u>Density (g/cm<sup>3</sup>)</u>	<u>Velocity (m/s)</u>
1	4.000	1.829	---
2	4.000	1.832	8210
3	4.000	1.832	8220
4	4.000	1.833	8223
5	4.000	1.832	8228
6	4.000	1.832	8224

**Average velocity of increments 2-6:** 8221 m/s

DETONATION VELOCITY DATA

**Material:** 77.3 wt% RDX/22.7 wt% Kel-F

**Experimenter:** J. B. Panowski      **Date:** May 24, 1954

**Shot no.:** GMX-2-275; GMX-8-B-3183

**Diameter:** 1.675 in.      **Average density:** 1.843 g/cm<sup>3</sup>      **Voids:** 0.2%

**Fabrication:** Vacuum pressed, machined      **Unconfined**

**Booster:** 1E15 detonator and Comp B

<u>Increment no.</u>	<u>Length (in.)</u>	<u>Density (g/cm<sup>3</sup>)</u>	<u>Velocity (m/s)</u>
1	3.500	1.843	---
2	4.000	1.843	8112
3	4.000	1.843	8150
4	4.000	1.843	8142
5	4.000	1.843	8150
6	4.000	1.844	8192

**Average velocity of increments 2-6:** 8149 m/s



**DETONATION VELOCITY DATA**

**Material:** 75 wt% RDX/25 wt% Kel-F

**Experimenter:** F. DuBois      **Date:** February 4, 1954

**Shot no.:** GMX-2-161; GMX-8-B-3060

**Diameter:** 1.625 in.      **Average density:** 1.850 g/cm<sup>3</sup>      **Voids:** ~0.3%

**Fabrication:** Vacuum pressed

**Booster:** 1E15 detonator and Comp B

<u>Increment no.</u>	<u>Length (in.)</u>	<u>Density (g/cm<sup>3</sup>)</u>	<u>Velocity (m/s)</u>
1	booster	1.849	---
2	4.000	1.851	8013
3	4.000	1.851	8009
4	4.000	1.850	8037
5	4.000	1.850	8022

**Average velocity of increments 2-5:** 8020 m/s

DETONATION VELOCITY DATA

**Material:** 75 wt% RDX/25 wt% Kel-F

**Experimenter:** F. DuBois      **Date:** February 11, 1954

**Shot no.:** GMX-2-145; GMX-8-B-3076

**Diameter:** 1.625 in.      **Average density:** 1.845 g/cm<sup>3</sup>      **Voids:** 0.6%

**Fabrication:** Vacuum pressed

**Booster:** 1E15 detonator and Comp B

<u>Increment no.</u>	<u>Length (in.)</u>	<u>Density (g/cm<sup>3</sup>)</u>	<u>Velocity (m/s)</u>
1	4.000	1.842	---
2	4.000	1.845	8022
3	4.000	1.845	8039
4	4.000	1.845	8027
5	4.000	1.846	8020

**Average velocity of increments 2-5:** 8027 m/s

DETONATION VELOCITY DATA

Material: 51.93 wt% RDX/40.83 wt% lead/7.24 wt% Kel-F

Experimenter: M. J. Urizar Date: November 7, 1955

Shot no.: GMX-2-846; GMX-8-B-3816

Diameter: 1.639 in. Average density: 2.741 g/cm<sup>3</sup> Voids: 1.3%

Booster: 1E15 detonator and Comp B

<u>Increment no.</u>	<u>Length (in.)</u>	<u>Density (g/cm<sup>3</sup>)</u>	<u>Velocity (m/s)</u>
1	3.000	2.742	7050
2	3.000	2.741	7045
3	3.000	2.740	7062
4	3.000	2.740	7052
5	3.000	2.740	7062
6	3.000	2.741	7067
7	3.000	2.741	7071
8	3.000	2.740	7065
9	3.000	2.740	7050

Average velocity of increments 1-9: 7058 m/s

DETONATION VELOCITY DATA

**Material:** 20 wt% RDX/55 wt% basic lead sulfate/25 wt% plastic

**Experimenter:** J. B. Panowski      **Date:** June 6, 1951

**Shot no.:** GMX-2-1960, -61, -62; GMX-8-FL-4498

**Diameter:** 3 in.      **Average density:** 3.9339 g/cm<sup>3</sup>

**Booster:** 1E15 detonator and P-40 lens

<u>Increment no.</u>	<u>Length (in.)</u>	<u>Density (g/cm<sup>3</sup>)</u>	<u>Velocity (m/s)</u>
1	3.100	3.9286	---
2	3.120	3.9327	3592
3	3.120	3.9403	3597

**Average velocity of increments 2 and 3:** 3595 m/s

DETONATION VELOCITY DATA

Material: 95 wt% RDX/5 wt% Neoprene GNA

Experimenter: J. B. Panowski Date: October 8, 1954

Shot no.: GMX-2-45I; GMX-8-B-3308

Diameter: 1.625 in. Average density: 1.747 g/cm<sup>3</sup> Voids: 0.74%

Booster: 1E15 detonator and Comp B

<u>Increment no.</u>	<u>Length (in.)</u>	<u>Density (g/cm<sup>3</sup>)</u>	<u>Velocity (m/s)</u>
1	4.000	1.747	---
2	4.000	1.747	8473
3	4.000	1.747	8484
4	4.000	1.748	8485
5	4.000	1.747	8483
6	4.000	1.748	8482
7	4.000	1.746	8482

Average velocity of increments 2-7: 8482 m/s

## DETONATION VELOCITY DATA

**Material:** 90 wt% RDX/8 wt% NC/2 wt% TOF

**Experimenter:** J. B. Panowski      **Date:** March 20, 1954

**Shot no.:** GMX-2-NC; GMX-8-B-3109

**Diameter:** 1.625 in.      **Average density:** 1.704 g/cm<sup>3</sup>

**Booster:** 1E15 detonator

<u>Increment no.</u>	<u>Length (in.)</u>	<u>Density (g/cm<sup>3</sup>)</u>	<u>Velocity (m/s)</u>
1	4.000	1.699	---
2	4.000	1.709	8308
3	4.000	1.703	8302
4	4.000	1.703	8308

**Average velocity of increments 2-4:** 8306 m/s

**Material:** 90 wt% RDX/8 wt% NC/2 wt% TOF

**Experimenter:** J. B. Panowski      **Date:** March 20, 1954

**Shot no.:** GMX-2-NC; GMX-8-B-3110

**Diameter:** 1.625 in.      **Average density:** 1.704 g/cm<sup>3</sup>

**Booster:** 1E15 detonator and Comp B

<u>Increment no.</u>	<u>Length (in.)</u>	<u>Density (g/cm<sup>3</sup>)</u>	<u>Velocity (m/s)</u>
1	4.000	1.697	---
2	4.000	1.706	8314
3	4.000	1.705	8314
4	4.000	1.706	8316

**Average velocity of increments 2-4:** 8315 m/s

DETONATION VELOCITY DATA

Material: 90 wt% RDX/8 wt% NC/2 wt% TOF

Experimenter: J. B. Panowski Date: March 22, 1954

Shot no.: GMX-2-NC; GMX-8-B-3106

Diameter: 1.625 in. Average density: 1.713 g/cm<sup>3</sup>

Booster: 1E15 detonator and Comp B

Increment no.	Length (in.)	Density (g/cm <sup>3</sup> )	Velocity (m/s)
1	3.000	1.712	---
2	3.000	1.713	8333
3	3.000	1.713	8336
4	3.000	1.713	8312

Average velocity of increments 2-4: 8327 m/s

Material: 90 wt% RDX/8 wt% NC/2 wt% TOF

Experimenter: J. B. Panowski Date: March 22, 1954

Shot no.: GMX-2-NC; GMX-8-B-3105

Diameter: 1.625 in. Average density: 1.713 g/cm<sup>3</sup>

Booster: 1E15 detonator and Comp B

Increment no.	Length (in.)	Density (g/cm <sup>3</sup> )	Velocity (m/s)
1	3.000	1.711	---
2	3.000	1.714	8321
3	3.000	1.713	8329
4	3.000	1.713	8344

Average velocity of increments 2-4: 8331 m/s

DETONATION VELOCITY DATA

Material: 90 wt% RDX/8 wt% NC/2 wt% TOF

Experimenter: J. B. Panowski Date: April 13, 1954

Shot no.: GMX-2-234-B; GMX-8-B-3128

Diameter: 1.625 in. Average density: 1.724 g/cm<sup>3</sup>

Booster: 1E15 detonator and Comp B

<u>Increment no.</u>	<u>Length (in.)</u>	<u>Density (g/cm<sup>3</sup>)</u>	<u>Velocity (m/s)</u>
1	4.000	1.723	---
2	4.000	1.723	8374
3	4.000	1.723	8373
4	3.875	1.726	8377
5	4.000	1.723	8362

Average velocity of increments 2-5: 8372 m/s



DETONATION VELOCITY DATA

**Material:** 90 wt% RDX/8 wt% NC/2 wt% TOF

**Experimenter:** J. B. Panowski      **Date:** April 13, 1954

**Shot no.:** GMX-2-234-A; GMX-8-B-3127

**Diameter:** 1.625 in.      **Average density:** 1.724 g/cm<sup>3</sup>

**Booster:** 1E15 detonator and Comp B

<u>Increment no.</u>	<u>Length (in.)</u>	<u>Density (g/cm<sup>3</sup>)</u>	<u>Velocity (m/s)</u>
1	4.000	1.724	--
2	4.000	1.723	8376
3	4.000	1.724	8373
4	4.000	1.724	8369
5	4.000	1.724	8377

**Average velocity of increments 2-5:** 8374 m/s

DETONATION VELOCITY DATA

**Material:** 94 wt% RDX/3 wt% Paracril/3 wt% PS

**Experimenter:** J. B. Panowski      **Date:** March 22, 1954

**Shot no.:** GMX-2-219-3; GMX-8-B-3108

**Diameter:** 1.625 in.      **Average density:** 1.704 g/cm<sup>3</sup>

**Booster:** 1E15 detonator and Comp B

<u>Increment no.</u>	<u>Length (in.)</u>	<u>Density (g/cm<sup>3</sup>)</u>	<u>Velocity (m/s)</u>
1	4.000	1.701	---
2	4.000	1.704	8396
3	4.000	1.705	8369
4	4.000	1.704	8370

**Average velocity of increments 2-4:** 8378 m/s

**Material:** 94 wt% RDX/3 wt% Paracril/3 wt% PS

**Experimenter:** J. B. Panowski      **Date:** March 22, 1954

**Shot no.:** GMX-2-219-4; GMX-8-B-3107

**Diameter:** 1.625 in.      **Average density:** 1.705 g/cm<sup>3</sup>

**Booster:** 1E15 detonator and Comp B

<u>Increment no.</u>	<u>Length (in.)</u>	<u>Density (g/cm<sup>3</sup>)</u>	<u>Velocity (m/s)</u>
1	4.000	1.704	---
2	4.000	1.705	8401
3	4.000	1.705	8412
4	4.000	1.705	8409

**Average velocity of increments 2-4:** 8407 m/s

DETONATION VELOCITY DATA

**Material:** 92 wt% RDX/6 wt% PS/2 wt% DOP

**Experimenter:** E. James, Jr.      **Date:** February 12, 1954

**Shot no.:** GMX-2-103-F; GMX-8-B-3081

**Diameter:** 0.167 in.      **Average density:** 1.6875 g/cm<sup>3</sup>      **Voids:** <0.5%

**Fabrication:** Vacuum cast at 110°C under 15 000 psi

**Booster:** 1E15 detonator

<u>Increment no.</u>	<u>Length (in.)</u>	<u>Velocity (m/s)</u>
1	---	---
2	---	---
3	2.0008	8140
4	2.0005	8145
5	2.0005	8157
6	2.0005	8127
7	2.0005	8127
8	2.0006	8159

**Average velocity of increments 3-8:** 8143 m/s

DETONATION VELOCITY DATA

**Material:** 92 wt% RDX/6 wt% PS/2 wt% DOP

**Experimenter:** E. James, Jr.      **Date:** February 12, 1954

**Shot no.:** GMX-2-103-E; GMX-8-B-3084

**Diameter:** 0.200 in.      **Average density:** 1.6875 g/cm<sup>3</sup>      **Voids:** <0.5%

**Booster:** 1E15 detonator

<u>Increment no.</u>	<u>Length (in.)</u>	<u>Velocity (m/s)</u>
1	---	---
2	---	---
3	2.0007	8195
4	2.0003	8194
5	2.0005	8162
6	2.0006	8161
7	2.0010	8139
8	2.0006	8164

**Average velocity of increments 3-8:** 8169 m/s

DETONATION VELOCITY DATA

**Material:** 92 wt% RDX/6 wt% PS/2 wt% DOP

**Experimenter:** E. James, Jr.     **Date:** February 12, 1954

**Shot no.:** GMX-2-103-D; GMX-8-B-3085

**Diameter:** 0.250 in.     **Average density:** 1.6875 g/cm<sup>3</sup>     **Voids:** 0.5%

**Booster:** 1E15 detonator

<u>Increment no.</u>	<u>Length (in.)</u>	<u>Velocity (m/s)</u>
1	---	---
2	---	---
3	2.0002	8223
4	2.0002	8198
5	2.0003	8284
6	2.0004	8168
7	2.0004	8201
8	2.0004	8203

**Average velocity of increments 3-8:** 8213 m/s

DETONATION VELOCITY DATA

**Material:** 92 wt% RDX/6 wt% PS/2 wt% DOP

**Experimenter:** E. James, Jr.      **Date:** February 12, 1954

**Shot no.:** GMX-2-103-B; GMX-8-B-3089

**Diameter:** 0.5000 in.      **Average density:** 1.6875 g/cm<sup>3</sup>      **Voids:** <0.5%

**Booster:** 1E15 detonator

<u>Increment no.</u>	<u>Length (in.)</u>	<u>Velocity (m/s)</u>
1	---	---
2	---	---
3	2.0005	8259
4	2.0004	8235
5	2.0001	8263
6	2.0004	8259
7	2.0005	8227
8	2.0005	8275

**Average velocity of increments 3-8:** 8253 m/s

DETONATION VELOCITY DATA

**Material:** 92 wt% RDX/6 wt% PS/2 wt% DOP

**Experimenter:** E. James, Jr.      **Date:** February 12, 1954

**Shot no.:** GMX-2-103-A; GMX-8-B-3088

**Diameter:** 1.000 in.      **Average density:** 1.6875 g/cm<sup>3</sup>      **Voids:** <0.5%

**Booster:** 1E15 detonator

<u>Increment no.</u>	<u>Length (in.)</u>	<u>Velocity (m/s)</u>
1	---	---
2	---	---
3	2.0010	8260
4	2.0007	8253
5	2.0007	8267
6	2.0007	8261
7	2.0005	8283
8	2.0005	8266

**Average velocity of increments 3-8:** 8265 m/s

DETONATION VELOCITY DATA

Material: 92 wt% RDX/6 wt% PS/2 wt% DOP at 64.54°F

Experimenter: E. James, Jr. Date: January 5, 1954

Shot no.: GMX-2-103-3; GMX-8-D-4331

Diameter: 2 in. Average density: 1.6874 g/cm<sup>3</sup> Voids: <0.5%

Booster: 1E15 detonator

<u>Increment no.</u>	<u>Length (in.)</u>	<u>Density (g/cm<sup>3</sup>)</u>	<u>Velocity (m/s)</u>
1	---	---	---
2	---	---	---
3	1.9995	1.6872	8281
4	1.9990	1.6873	8269
5	2.0005	1.6877	8276
6	2.0005	1.6874	8291

Average velocity of increments 3-6: 8279 m/s



DETONATION VELOCITY DATA

Material: 92 wt% RDX/6 wt% PS/2 wt% DOP at 65.72°F

Experimenter: E. James, Jr. Date: January 5, 1954

Shot no.: GMX-2-103-7; GMX-8-D-4328

Diameter: 0.500 in. Average density: 1.6874 g/cm<sup>3</sup> Voids: <0.5%

Booster: 1E15 detonator

<u>Increment no.</u>	<u>Length (in.)</u>	<u>Density (g/cm<sup>3</sup>)</u>	<u>Velocity (m/s)</u>
1	---	---	---
2	---	---	---
3	1.9998	1.6874	8267
4	1.9998	1.6876	8268
5	2.0000	1.6876	8269
6	1.9996	1.6869	---

Average velocity of increments 3-5: 8268 m/s

DETONATION VELOCITY DATA

Material: 92 wt% RDX/6 wt% PS/2 wt% DOP at 68.03°F

Experimenter: E. James, Jr. Date: January 5, 1954

Shot no.: GMX-2-103-6; GMX-8-D-4332

Diameter: 1.000 in. Average density: 1.6874 g/cm<sup>3</sup> Voids: <0.5%

Booster: 1E15 detonator

<u>Increment no.</u>	<u>Length (in.)</u>	<u>Density (g/cm<sup>3</sup>)</u>	<u>Velocity (m/s)</u>
1	---	---	---
2	---	---	---
3	2.0000	1.6875	8286
4	1.9990	1.6876	8279
5	2.0005	1.6875	8270
6	1.9995	1.6871	8269

Average velocity of increments 3-6: 8276 m/s

DETONATION VELOCITY DATA

Material: 92 wt% RDX/6 wt% PS/2 wt% DOP at 68.69°F

Experimenter: E. James, Jr. Date: January 5, 1954

Shot no.: GMX-2-103-8; GMX-8-D-4338

Diameter: 0.500 in. Average density: 1.6872 g/cm<sup>3</sup> Voids: <0.5%

Booster: 1E15 detonator

<u>Increment no.</u>	<u>Length (in.)</u>	<u>Density (g/cm<sup>3</sup>)</u>	<u>Velocity (m/s)</u>
1	---	---	---
2	---	---	---
3	1.9999	1.6874	8188
4	1.9990	1.6872	8267
5	1.9985	1.6875	8242
6	1.9991	1.6868	8255

Average velocity of increments 3-6: 8238 m/s

## DETONATION VELOCITY DATA

**Material:** 92 wt% RDX/6 wt% PS/2 wt% DOP at 70°F

**Experimenter:** E. James, Jr.      **Date:** January 5, 1954

**Shot no.:** GMX-2-103-5; GMX-8-D-4335

**Diameter:** 1.000 in.      **Average density:** 1.6869 g/cm<sup>3</sup>      **Voids:** <0.5%

**Booster:** 1E15 detonator

<u>Increment no.</u>	<u>Length (in.)</u>	<u>Density (g/cm<sup>3</sup>)</u>	<u>Velocity (m/s)</u>
1	---	---	---
2	---	---	---
3	1.9995	1.6868	8273
4	2.0000	1.6866	8284
5	1.9982	1.6874	8270
6	2.0000	1.6868	8281

**Average velocity of increments 3-6:** 8277 m/s

DETONATION VELOCITY DATA

**Material:** 92 wt% RDX/6 wt% PS/2 wt% DOP at 71.79°F

**Experimenter:** E. James, Jr.    **Date:** January 5, 1954

**Shot no.:** GMX-2-103-1; GMX-8-D-4337

**Diameter:** 2 in.    **Average density:** 1.6876 g/cm<sup>3</sup>    **Voids:** <0.5%

**Booster:** 1E15 detonator

<u>Increment no.</u>	<u>Length (in.)</u>	<u>Density (g/cm<sup>3</sup>)</u>	<u>Velocity (m/s)</u>
1	---	---	---
2	---	---	---
3	1.9995	1.6873	8266
4	2.0000	1.6877	8268
5	2.0000	1.6879	8278
6	1.9990	1.6874	8286

**Average velocity of increments 3-6:** 8275 m/s

DETONATION VELOCITY DATA

Material: 92 wt% RDX/6 wt% PS/2 wt% DOP at 71.79°F

Experimenter: E. James, Jr. Date: January 5, 1954

Shot no.: GMX-2-103-4; GMX-8-D-4336

Diameter: 1.000 in. Average density: 1.6874 g/cm<sup>3</sup> Voids: <0.5%

Booster: 1E15 detonator

<u>Increment no.</u>	<u>Length (in.)</u>	<u>Density (g/cm<sup>3</sup>)</u>	<u>Velocity (m/s)</u>
1	---	---	---
2	---	---	---
3	2.0000	1.6877	8283
4	2.0005	1.6871	8277
5	2.0005	1.6868	8274
6	2.0010	1.6878	8278

Average velocity of increments 3-6: 8278 m/s

**DETONATION VELOCITY DATA**

**Material:** 91 wt% RDX/7 wt% PS/2 wt% DOP

**Experimenter:** E. James, Jr.      **Date:** May 8, 1952

**Shot no.:** GMX-8-B-1220

**Diameter:** 1.504 in.      **Average density:** 1.627 g/cm<sup>3</sup>      **Voids:** 3.72%

**Booster:** 1E15 detonator and P-015 lens

<u>Increment no.</u>	<u>Length (in.)</u>	<u>Velocity (m/s)</u>
1	---	---
2	2.111	8029
3	2.111	8019
4	2.111	8041
5	2.112	8043
6	2.112	8027

**Average velocity of increments 2-6:** 8032 m/s

## DETONATION VELOCITY DATA

**Material:** 91 wt% RDX/7 wt% PS/2 wt% DOP

**Experimenter:** E. James, Jr.    **Date:** May 8, 1952

**Shot no.:** GMX-8-B-1208

**Diameter:** 1.504 in.    **Average density:** 1.628 g/cm<sup>3</sup>    **Voids:** 3.67%

**Booster:** 1E15 detonator and P-015 lens

<u>Increment no.</u>	<u>Length (in.)</u>	<u>Velocity (m/s)</u>
1	---	---
2	2.112	8028
3	2.111	8043
4	2.111	8052
5	2.112	8021
6	2.112	8043

**Average velocity of increments 2-6:** 8037 m/s



**DETONATION VELOCITY DATA**

**Material:** 91 wt% RDX/7 wt% PS/2 wt% DOP

**Experimenter:** E. James, Jr.      **Date:** May 8, 1952

**Shot no.:** GMX-8-B-1219

**Diameter:** 1.504 in.      **Average density:** 1.630 g/cm<sup>3</sup>      **Voids:** 3.55%

**Booster:** 1E15 detonator and P-015 lens

<u>Increment no.</u>	<u>Length (in.)</u>	<u>Velocity (m/s)</u>
1	---	---
2	2.111	8034
3	2.111	8024
4	2.112	8053
5	2.111	8037
6	2.112	8037

**Average velocity of increments 2-6:** 8037 m/s

DETONATION VELOCITY DATA

**Material:** 91 wt% RDX/7 wt% PS/2 wt% DOP

**Experimenter:** E. James, Jr.      **Date:** May 8, 1952

**Shot no.:** GMX-8-B-1223

**Diameter:** 1.504 in.      **Average density:** 1.625 g/cm<sup>3</sup>      **Voids:** 3.85%

**Booster:** 1E15 detonator

<u>Increment no.</u>	<u>Length (in.)</u>	<u>Velocity (m/s)</u>
1	---	---
2	2.112	8021
3	2.112	8050
4	2.111	8049
5	2.110	8015
6	2.112	8056

**Average velocity of increments 2-6:** 8038 m/s

**DETONATION VELOCITY DATA**

**Material:** 91 wt% RDX/7 wt% PS/2 wt% DOP

**Experimenter:** E. James, Jr.      **Date:** May 8, 1952

**Shot no.:** GMX-8-B-1224

**Diameter:** 1.504 in.      **Average density:** 1.626 g/cm<sup>3</sup>      **Voids:** 3.79%

**Booster:** 1E15 detonator and P-015 lens

<u>Increment no.</u>	<u>Length (in.)</u>	<u>Velocity (m/s)</u>
1	---	---
2	2.112	8057
3	2.112	8039
4	2.112	8056
5	2.112	8038
6	2.112	8003

**Average velocity of increments 2-6:** 8039 m/s

DETONATION VELOCITY DATA

**Material:** 90.77 wt% RDX/7.20 wt% PS/2.03 wt% DOP

**Experimenter:** K. Fess     **Date:** January 7, 1953

**Shot no.:** GMX-2-12945; GMX-8-D-3821

**Diameter:** 1.5 in.     **Average density:** 1.591 g/cm<sup>3</sup>

**Booster:** 1E15 detonator and P-040 lens

<u>Increment no.</u>	<u>Length (in.)</u>	<u>Density (g/cm<sup>3</sup>)</u>	<u>Velocity (m/s)</u>
1	0.9998	1.591	---
2	0.9985	1.590	7965
3	0.9998	1.591	8003
4	0.9992	1.591	7869
5	0.9995	1.591	7973
6	1.0000	1.591	7937
7	0.9998	1.591	7958
8	1.0003	1.592	7915
9	1.000	1.592	7917
10	0.9998	1.592	7958
11	0.9992	1.592	7908
12	0.9992	1.592	7948
13	0.9992	1.592	7948
14	0.9992	1.592	7926
15	1.000	1.592	7947

**Average velocity of increments 2-15:** 7941 m/s

**DETONATION VELOCITY DATA**

**Material:** 90.77 wt% RDX/2.03 wt% DOP/7.20 wt% PS

**Experimenter:** K. Fess      **Date:** January 7, 1953

**Shot no.:** GMX-2-12977; GMX-8-D-3822

**Diameter:** 1.5 in.      **Average density:** 1.593 g/cm<sup>3</sup>

**Booster:** 1E15 detonator and P-040 lens

<u>Increment no.</u>	<u>Length (in.)</u>	<u>Density (g/cm<sup>3</sup>)</u>	<u>Velocity (m/s)</u>
1	0.9990	1.592	7882
2	0.9989	1.592	7852
3	0.9992	1.593	7833
4	1.0000	1.593	7957
5	0.9990	1.593	7974
6	0.9990	1.593	7919
7	0.9991	1.593	7927
8	0.9992	1.593	7946
9	0.9990	1.593	7932
10	0.9990	1.593	7917
11	1.0000	1.593	7977
12	1.0000	1.593	7930
13	1.0000	1.593	7964
14	1.0003	1.593	7983

**Average velocity of increments 1-14:** 7928 m/s

DETONATION VELOCITY DATA

**Material:** 90.7 wt% RDX/7.3 wt% PS/2 wt% DOP

**Experimenter:** K. Fess      **Date:** October 15, 1952

**Shot no.:** GMX-2-11824; GMX-8-FL-6466

**Diameter:** 1.625 in.      **Average density:** 1.6230 g/cm<sup>3</sup>

**Booster:** 1E15 detonator and P-016 lens

<b>Increment no.</b>	<b>Length (in.)</b>	<b>Density (g/cm<sup>3</sup>)</b>	<b>Velocity (m/s)</b>
1	1.003	1.6236	---
2	1.003	1.6237	8018
3	1.003	1.6237	8018
4	1.003	1.6237	8036
5	1.002	1.6237	8010
6	1.004	1.6238	7996
7	1.003	1.6240	8049
8	1.004	1.6241	7996
9	1.002	1.6242	8102
10	1.002	1.6243	7960
11	1.003	1.6243	8039
12	1.003	1.6246	8044
13	1.002	1.6246	7993
14	1.003	1.6246	8013
15	1.002	1.6246	8010

**Average velocity of increments 2-15:** 8020 m/s

DETONATION VELOCITY DATA

**Material:** 90.7 wt% RDX/7.3 wt% PS/2 wt% DOP

**Experimenter:** K. Fess      **Date:** October 15, 1952

**Shot no.:** GMX-2-11816; GMX-8-FL-6465

**Diameter:** 1.625 in.      **Average density:** 1.6260 g/cm<sup>3</sup>

**Booster:** 1E15 detonator and P-016 lens

<u>Increment no.</u>	<u>Length (in.)</u>	<u>Density (g/cm<sup>3</sup>)</u>	<u>Velocity (m/s)</u>
1	0.999	1.6294	---
2	1.000	1.6283	---
3	1.002	1.6267	8066
4	1.002	1.6261	7983
5	1.003	1.6260	8056
6	1.004	1.6259	8031
7	1.002	1.6258	7988
8	1.003	1.6254	8046
9	1.002	1.6254	8036
10	1.002	1.6254	8018
11	1.005	1.6255	8040
12	1.003	1.6251	8011
13	1.004	1.6250	8065
14	1.003	1.6250	8041
15	1.003	1.6250	8036

**Average velocity of increments 3-15:** 8032 m/s

DETONATION VELOCITY DATA

**Material:** 90 wt% ball-milled RDX/9.8 wt% PS/0.2 wt% DOP

**Experimenter:** F. DuBois      **Date:** May 18, 1953

**Shot no.:** GMX-2-13394; GMX-8-B-2428

**Diameter:** 1 in.      **Average density:** 1.000 g/cm<sup>3</sup>      **Voids:** 40.9%

**Fabrication:** Slurry, pressed

**Booster:** 1E15 detonator and Comp B

<u>Increment no.</u>	<u>Length (in.)</u>	<u>Density (g/cm<sup>3</sup>)</u>	<u>Velocity (m/s)</u>
1	2.0000	1.000 ± 0.001	---
2	2.0000	1.000 ± 0.001	5640
3	2.0000	1.000 ± 0.001	5642
4	2.0000	1.000 ± 0.001	5662

**Average velocity of increments 2-4:** 5648 m/s



DETONATION VELOCITY DATA

**Material:** 90 wt% ball-milled RDX/9.8 wt% PS/0.2 wt% DOP

**Experimenter:** F. DuBois      **Date:** May 18, 1953

**Shot no.:** GMX-2-13393; GMX-8-B-2427

**Diameter:** 1 in.      **Average density:** 1.000 g/cm<sup>3</sup>      **Voids:** 40.9%

**Fabrication:** Slurry, pressed

**Booster:** 1E15 detonator and Comp B

<u>Increment no.</u>	<u>Length (in.)</u>	<u>Density (g/cm<sup>3</sup>)</u>	<u>Velocity (m/s)</u>
1	2.0000	1.000 ± 0.001	---
2	2.0000	1.000 ± 0.001	5685
3	2.0000	1.000 ± 0.001	5645
4	2.0000	1.000 ± 0.001	5671

**Average velocity of increments 2-4:** 5667 m/s

DETONATION VELOCITY DATA

**Material:** 90 wt% RDX/9.8 wt% PS/0.2 wt% DOP

**Experimenter:** F. DuBois      **Date:** July 6, 1953

**Shot no.:** GMX-2-13407; GMX-8-B-2566

**Diameter:** 1 in.      **Average density:** 1.305 g/cm<sup>3</sup>

**Fabrication:** Slurry, pressed

**Booster:** 1E15 detonator and Comp B

<u>Increment no.</u>	<u>Length (in.)</u>	<u>Density (g/cm<sup>3</sup>)</u>	<u>Velocity (m/s)</u>
1	2.0073	1.305	---
2	2.0068	1.305	6988
3	2.0065	1.304	6978
4	2.0065	1.304	7006

**Average velocity of increments 2-4:** 6991 m/s

DETONATION VELOCITY DATA

**Material:** 90 wt% jar-milled RDX/9.8 wt% PS/0.2 wt% DOP

**Experimenter:** F. DuBois      **Date:** July 14, 1953

**Shot no.:** GMX-2-13419; GMX-8-B-2590

**Diameter:** 1 in.      **Average density:** 1.305 g/cm<sup>3</sup>

**Fabrication:** Slurry, pressed

**Booster:** 1E15 detonator and Comp B

<u>Increment no.</u>	<u>Length (in.)</u>	<u>Density (g/cm<sup>3</sup>)</u>	<u>Velocity (m/s)</u>
1	---	---	---
2	---	---	---
3	2.0070	1.305	6997
4	2.0078	1.305	7032
5	2.0055	1.305	7003

**Average velocity of increments 3-5:** 7011 m/s

## DETONATION VELOCITY DATA

**Material:** 90 wt% jar-milled RDX/9.8 wt% PS/0.2 wt% DOP

**Experimenter:** F. DuBois     **Date:** July 15, 1953

**Shot no.:** GMX-2-13417; GMX-8-B-2589

**Diameter:** 1 in.     **Average density:** 1.452 g/cm<sup>3</sup>

**Fabrication:** Slurry, pressed

**Booster:** 1E15 detonator and Comp B

<u>Increment no.</u>	<u>Length (in.)</u>	<u>Density (g/cm<sup>3</sup>)</u>	<u>Velocity (m/s)</u>
1	---	---	---
2	---	---	---
3	2.0100	1.452	7543
4	2.0094	1.452	7515
5	2.0093	1.452	7533

**Average velocity of increments 3-5:** 7530 m/s

DETONATION VELOCITY DATA

**Material:** 90 wt% jar-milled RDX/9.8 wt% PS/0.2 wt% DOP

**Experimenter:** F. DuBois      **Date:** July 14, 1953

**Shot no.:** GMX-2-13414; GMX-8-B-2581

**Diameter:** 1 in.      **Average density:** 1.452 g/cm<sup>3</sup>

**Fabrication:** Slurry, pressed

**Booster:** 1E15 detonator and Comp B

<u>Increment no.</u>	<u>Length (in.)</u>	<u>Density (g/cm<sup>3</sup>)</u>	<u>Velocity (m/s)</u>
1	---	---	---
2	2.0101	1.452	7570
3	2.0111	1.452	7520
4	2.0090	1.452	7566

**Average velocity of increments 2-4:** 7552 m/s

DETONATION VELOCITY DATA

**Material:** 90 wt% NSJ-30B RDX/9.8 wt% PS/0.2 wt% DOP

**Experimenter:** F. DuBois      **Date:** October 29, 1953

**Shot no.:** GMX-2-76-D; GMX-8-B-2840

**Diameter:** 1 in.      **Average density:** 1.522 g/cm<sup>3</sup>      **Voids:** 10%

**Fabrication:** Slurry, pressed

**Booster:** 1E15 detonator

<u>Increment no.</u>	<u>Length (in.)</u>	<u>Density (g/cm<sup>3</sup>)</u>	<u>Velocity (m/s)</u>
1	---	---	---
2	---	---	---
3	---	---	---
4	1.024	1.520	---
5	1.024	1.520	7585
6	1.022	1.524	---
7	1.022	1.524	7618
8	1.023	1.523	---
9	1.023	1.523	7626

**Average velocity of increments 5-9:** 7610 m/s

**DETONATION VELOCITY DATA**

**Material:** 90 wt% jar-milled RDX/9.8 wt% PS/0.2 wt% DOP

**Experimenter:** F. DuBois      **Date:** July 14, 1953

**Shot no.:** GMX-2-13415; GMX-8-B-2582

**Diameter:** 1 in.      **Average density:** 1.592 g/cm<sup>3</sup>

**Fabrication:** Slurry, pressed

**Booster:** 1E15 detonator and Comp B

<u>Increment no.</u>	<u>Length (in.)</u>	<u>Density (g/cm<sup>3</sup>)</u>	<u>Velocity (m/s)</u>
1	---	---	---
2	2.0178	1.592	7986
3	2.0167	1.592	---
4	2.0173	1.592	7971

**Average velocity of increments 2-4:** 7979 m/s

## DETONATION VELOCITY DATA

**Material:** 90 wt% RDX/9.8 wt% PS/0.2 wt% DOP

**Experimenter:** F. DuBois      **Date:** July 6, 1953

**Shot no.:** GMX-2-13406; GMX-8-B-2567

**Diameter:** 1 in.      **Average density:** 1.592 g/cm<sup>3</sup>

**Fabrication:** Slurry, pressed

**Booster:** 1E15 detonator and Comp B

<u>Increment no.</u>	<u>Length (in.)</u>	<u>Density (g/cm<sup>3</sup>)</u>	<u>Velocity (m/s)</u>
1	2.0176	---	---
2	2.0174	1.592	7975
3	2.0198	1.592	7976
4	2.0168	1.593	7987

**Average velocity of increments 2-4:** 7979 m/s



DETONATION VELOCITY DATA

Material: 90 wt% RDX/8.5 wt% PS/1.5 wt% DOP

Experimenter: K. Fess Date: November 7, 1952

Shot no.: GMX-2-12330; GMX-8-FL-6467

Diameter: 1.625 in. Average density: 1.607 g/cm<sup>3</sup>

Booster: P-040 lens

<u>Increment no.</u>	<u>Length (in.)</u>	<u>Density (g/cm<sup>3</sup>)</u>	<u>Velocity (m/s)</u>
1	1.012	1.605	7916
2	1.010	1.607	7959
3	1.011	1.607	8017
4	1.010	1.607	7925
5	1.011	1.607	7976
6	1.011	1.607	8077
7	1.010	1.607	7933
8	1.011	1.607	7925
9	1.010	1.607	7989
10	1.010	1.607	7986
11	1.011	1.607	7984
12	1.011	1.607	7984
13	1.0105	1.607	7975
14	1.011	1.607	---
15	1.011	1.607	---

Average velocity of increments 1-13: 7973 m/s

DETONATION VELOCITY DATA

**Material:** 90 wt% RDX/8.5 wt% PS/1.5 wt% DOP

**Experimenter:** K. Fess      **Date:** November 7, 1952

**Shot no.:** GMX-2-12325; GMX-8-FL-6468

**Diameter:** 1.625 in.      **Average density:** 1.608 g/cm<sup>3</sup>

**Booster:** 1E15 detonator and P-016 lens

<u>Increment no.</u>	<u>Length (in.)</u>	<u>Density (g/cm<sup>3</sup>)</u>	<u>Velocity (m/s)</u>
1	1.011	1.609	7947
2	1.011	1.609	8105
3	1.010	1.609	7748
4	1.010	1.609	7954
5	1.011	1.608	7994
6	1.011	1.608	8032
7	1.010	1.608	7981
8	1.010	1.608	8011
9	1.010	1.608	7937
10	1.010	1.608	8016
11	1.010	1.608	8034
12	1.010	1.608	7967
13	1.011	1.608	8088
14	1.010	1.608	7852
15	1.011	1.608	---

**Average velocity of increments 1-14:** 7976 m/s

**DETONATION VELOCITY DATA**

**Material:** 90.77 wt% RDX/6.81 wt% DOP/1.92 wt% PS/0.5 wt% carbon

**Experimenter:** K. Fess      **Date:** January 7, 1953

**Shot no.:** GMX-2-12964; GMX-8-D-3824

**Diameter:** 1.5 in.      **Average density:** 1.600 g/cm<sup>3</sup>

**Booster:** 1E15 detonator and P-040 lens

<u>Increment no.</u>	<u>Length (in.)</u>	<u>Density (g/cm<sup>3</sup>)</u>	<u>Velocity (m/s)</u>
1	0.9992	1.597	---
2	0.9998	1.603	7938
3	0.9989	1.597	7981
4	1.0005	1.603	7931
5	0.9990	1.598	7939
6	1.0040	1.603	7974
7	0.9992	1.597	7966
8	1.0010	1.602	7947
9	0.9991	1.596	7945
10	1.0020	1.603	7926
11	0.9992	1.596	7951
12	1.0010	1.603	7933
13	0.9990	1.596	7937
14	1.0008	1.604	7986

**Average velocity of increments 2-14:** 7950 m/s

DETONATION VELOCITY DATA

**Material:** 90.77 wt% RDX/6.81 wt% PS/1.92 wt% DOP/0.5 wt% carbon

**Experimenter:** K. Fess      **Date:** January 7, 1953

**Shot no.:** GMX-2-13065; GMX-8-D-3823

**Diameter:** 1.5 in.      **Average density:** 1.609 g/cm<sup>3</sup>

**Booster:** 1E15 detonator and P-040 lens

<u>Increment no.</u>	<u>Length (in.)</u>	<u>Density (g/cm<sup>3</sup>)</u>	<u>Velocity (m/s)</u>
1	1.0005	1.609	7993
2	1.0010	1.609	7952
3	1.0010	1.609	7940
4	1.0005	1.609	7973
5	1.0005	1.609	7981
6	1.0010	1.609	7947
7	1.0005	1.609	7943
8	1.0007	1.609	7977
9	1.0010	1.609	7937
10	1.0009	1.609	7989
11	1.0003	1.609	7939
12	1.0005	1.609	7934
13	1.0005	1.609	7914
14	1.0005	1.609	7963
15	1.0005	1.609	7998

**Average velocity of increments 1-15:** 7959 m/s

**DETONATION VELOCITY DATA**

**Material:** 90 wt% RDX/9.2 wt% PS/0.5 wt% DOP/0.3 wt% resin

**Experimenter:** E. James, Jr.    **Date:** November 10, 1953

**Shot no.:** GMX-2-93; GMX-8-B-2874

**Diameter:** 1.509 in.    **Average density:** 1.674 g/cm<sup>3</sup>

**Booster:** 1E15 detonator

<u>Increment no.</u>	<u>Length (in.)</u>	<u>Density (g/cm<sup>3</sup>)</u>	<u>Velocity (m/s)</u>
1	1.1205	1.674	---
2	1.1228	1.672	---
3	1.1231	1.673	8166
4	1.1219	1.674	---
5	1.1225	1.675	8173

**Average velocity of increments 3-5:** 8170 m/s

DETONATION VELOCITY DATA

**Material:** 90 wt% RDX/9.2 wt% PS/0.5 wt% DOP/0.3 wt% resin

**Experimenter:** E. James, Jr.      **Date:** November 10, 1953

**Shot no.:** GMX-2-93; GMX-8-B-2873

**Diameter:** 1.509 in.      **Average density:** 1.673 g/cm<sup>3</sup>

**Booster:** 1E15 detonator and Comp B

<u>Increment no.</u>	<u>Length (in.)</u>	<u>Density (g/cm<sup>3</sup>)</u>	<u>Velocity (m/s)</u>
1	1.1221	1.674	---
2	1.121	1.673	---
3	1.1209	1.673	8178
4	1.121	1.673	---
5	1.122	1.673	8193

**Average velocity of increments 3-5:** 8186 m/s

DETONATION VELOCITY DATA

**Material:** 90 wt% RDX/9.2 wt% PS/0.5 wt% DOP/0.3 wt% resin

**Experimenter:** E. James, Jr.      **Date:** November 10, 1953

**Shot no.:** GMX-2-94; GMX-8-B-2872

**Diameter:** 1.508 in.      **Average density:** 1.681 g/cm<sup>3</sup>

**Booster:** 1E15 detonator and Comp B

<u>Increment no.</u>	<u>Length (in.)</u>	<u>Density (g/cm<sup>3</sup>)</u>	<u>Velocity (m/s)</u>
1	1.1185	1.680	--
2	1.1196	1.680	---
3	1.1185	1.681	8187
4	1.1185	1.681	---
5	1.1190	1.681	8186

**Average velocity of increments 3-5:** 8187 m/s

DETONATION VELOCITY DATA

Material: 60 wt% RDX/40 wt% potassium chloride

Experimenter: K. Fess Date: September 30, 1952

Shot no.: GMX-2-11704; GMX-8-FL-6344

Diameter: 3 in. Average density: 1.6651 g/cm<sup>3</sup> Voids: 11.17%

Booster: 1E15 detonator and P-040 lens

<u>Increment no.</u>	<u>Length (in.)</u>	<u>Density (g/cm<sup>3</sup>)</u>	<u>Velocity (m/s)</u>
1	0.500	1.6662	---
2	0.500	1.6656	---
3	0.500	1.6651	---
4	0.500	1.6650	---
5	0.500	1.6650	---
6	0.500	1.6648	---
7	0.500	1.6646	---
8	0.500	1.6646	6677
9	0.500	1.6646	---
10	0.500	1.6646	---
11	0.500	1.6646	---
12	0.500	1.6646	6891
13	0.500	1.6645	---
14	0.500	1.6645	---
15	0.500	1.6644	---
16	0.500	1.6643	6792

Average velocity of increments 8-16: 6787 m/s



DETONATION VELOCITY DATA

Material: 60 wt% RDX/40 wt% potassium chloride

Experimenter: K. Fess Date: September 30, 1952

Shot no.: GMX-2-11668; GMX-8-FL-6346

Diameter: 3 in. Average density: 1.6666 g/cm<sup>3</sup> Voids: 11.07%

Booster: 1E15 detonator and P-040 lens

<u>Increment no.</u>	<u>Length (in.)</u>	<u>Density (g/cm<sup>3</sup>)</u>	<u>Velocity (m/s)</u>
1	0.500	1.6669	---
2	0.500	1.6669	---
3	0.500	1.6669	---
4	0.500	1.6668	---
5	0.500	1.6668	---
6	0.500	1.6668	---
7	0.500	1.6667	---
8	0.500	1.6667	6833
9	0.500	1.6666	---
10	0.500	1.6665	---
11	0.500	1.6665	---
12	0.500	1.6665	6783
13	0.500	1.6665	---
14	0.500	1.6664	---
15	0.500	1.6664	---
16	0.500	1.6663	6731

Average velocity of increments 8-16: 6782 m/s

DETONATION VELOCITY DATA

Material: 60 wt% RDX/40 wt% potassium chloride

Experimenter: K. Fess Date: September 30, 1952

Shot no.: GMX-2-11686; GMX-8-FL-6345

Diameter: 3 in. Average density: 1.6675 g/cm<sup>3</sup> Voids: 11.00%

Booster: 1E15 detonator and P-040 lens

Increment no.	Length (in.)	Density (g/cm <sup>3</sup> )	Velocity (m/s)
1	0.500	1.6687	---
2	0.500	1.6684	---
3	0.500	1.6683	---
4	0.500	1.6682	---
5	0.500	1.6682	---
6	0.500	1.6681	---
7	0.500	1.6679	---
8	0.500	1.6678	6969
9	0.500	1.6678	---
10	0.500	1.6674	---
11	0.500	1.6673	---
12	0.500	1.6672	6792
13	0.500	1.6672	---
14	0.500	1.6672	---
15	0.500	1.6671	---
16	0.500	1.6670	6851

Average velocity of increments 8-16: 6871 m/s

DETONATION VELOCITY DATA

**Material:** 87.62 wt% RDX/12.38 wt% Saran E-242

**Experimenter:** J. B. Panowski      **Date:** August 31, 1954

**Shot no.:** GMX-2-365-B; GMX-8-B-3284

**Diameter:** 1.625 in.      **Average density:** 1.7829 g/cm<sup>3</sup>      **Voids:** <1.0%

**Booster:** 1E15 detonator and Comp B

<u>Increment no.</u>	<u>Length (in.)</u>	<u>Density (g/cm<sup>3</sup>)</u>	<u>Velocity (m/s)</u>
1	3.000	1.7827	---
2	3.000	1.7832	8342
3	3.000	1.7834	8347
4	3.000	1.7828	8348
5	3.000	1.7823	8339

**Average velocity of increments 2-5:** 8344 m/s

DETONATION VELOCITY DATA

Material: 87.62 wt% RDX/12.38 wt% Saran E-242

Experimenter: J. B. Panowski Date: August 31, 1954

Shot no.: GMX-2-365-A; GMX-8-B-3283

Diameter: 1.625 in. Average density: 1.7837 g/cm<sup>3</sup> Voids: <1.0%

Booster: 1E15 detonator and Comp B

<u>Increment no.</u>	<u>Length (in.)</u>	<u>Density (g/cm<sup>3</sup>)</u>	<u>Velocity (m/s)</u>
1	3.000	1.7838	---
2	3.000	1.7839	8336
3	3.000	1.7837	8356
4	3.000	1.7835	8334
5	3.000	1.7835	8339

Average velocity of increments 2-5: 8341 m/s

DETONATION VELOCITY DATA

**Material:** 88.6 wt% RDX/11.4 wt% Silastic 160

**Experimenter:** J. B. Panowski      **Date:** April 20, 1954

**Shot no.:** GMX-2-248-A; GMX-8-B-3152

**Diameter:** 1.625 in.      **Average density:** 1.799 g/cm<sup>3</sup>      **Voids:** 2.01%

**Booster:** 1E15 detonator and Comp B

<u>Increment no.</u>	<u>Length (in.)</u>	<u>Density (g/cm<sup>3</sup>)</u>	<u>Velocity (m/s)</u>
1	4.000	1.798	---
2	4.000	1.799	8165
3	4.000	1.801	8165
4	4.000	1.799	8165
5	4.000	1.800	8178

**Average velocity of increments 2-5:** 8168 m/s

DETONATION VELOCITY DATA

**Material:** 88.6 wt% RDX/11.4 wt% Silastic 160

**Experimenter:** J. B. Panowski      **Date:** April 20, 1954

**Shot no.:** GMX-2-248-B; GMX-8-B-3145

**Diameter:** 1.625 in.      **Average density:** 1.801 g/cm<sup>3</sup>      **Voids:** 2.01%

**Booster:** 1E15 detonator and Comp B

<u>Increment no.</u>	<u>Length (in.)</u>	<u>Density (g/cm<sup>3</sup>)</u>	<u>Velocity (m/s)</u>
1	4.000	1.800	---
2	4.000	1.801	8169
3	4.000	1.801	8171
4	4.000	1.801	8165
5	4.000	1.801	8172

**Average velocity of increments 2-5:** 8169 m/s

**DETONATION VELOCITY DATA**

**Material:** 85 wt% RDX/15 wt% Silastic 160

**Experimenter:** J. B. Panowski      **Date:** April 20, 1954

**Shot no.:** GMX-2-244-A; GMX-8-B-3146

**Diameter:** 1.625 in.      **Average density:** 1.810 g/cm<sup>3</sup>

**Booster:** 1E15 detonator and Comp B

<u>Increment no.</u>	<u>Length (in.)</u>	<u>Density (g/cm<sup>3</sup>)</u>	<u>Velocity (m/s)</u>
1	4.000	1.812	---
2	4.000	1.810	8003
3	4.000	1.810	8004
4	4.000	1.810	8001
5	4.000	1.810	8001

**Average velocity of increments 2-5:** 8002 m/s

DETONATION VELOCITY DATA

**Material:** 85 wt% RDX/15 wt% Silastic 160

**Experimenter:** J. B. Panowski      **Date:** April 20, 1954

**Shot no.:** GMX-2-244-B; GMX-8-B-3151

**Diameter:** 1.625 in.      **Average density:** 1.810 g/cm<sup>3</sup>

**Booster:** 1E15 detonator and Comp B

<u>Increment no.</u>	<u>Length (in.)</u>	<u>Density (g/cm<sup>3</sup>)</u>	<u>Velocity (m/s)</u>
1	4.000	1.809	---
2	4.000	1.810	7996
3	4.000	1.810	7994
4	4.000	1.813	8004
5	4.000	1.810	8015

**Average velocity of increments 2-5:** 8002 m/s



**DETONATION VELOCITY DATA**

**Material:** 83.3 wt% RDX/16.7 wt% Teflon

**Experimenter:** J. B. Panowski      **Date:** June 30, 1954

**Shot no.:** GMX-2-307-B; GMX-8-B-3256

**Diameter:** 1.625 in.      **Average density:** 1.832 g/cm<sup>3</sup>      **Voids:** ~1.5%

**Booster:** 1E15 detonator and P-016 lens

<u>Increment no.</u>	<u>Length (in.)</u>	<u>Density (g/cm<sup>3</sup>)</u>	<u>Velocity (m/s)</u>
1	4.000	1.830	---
2	2.000	1.833	8196
3	2.000	1.831	8234
4	2.000	1.833	8201
5	2.000	1.833	8196
6	2.000	1.833	8188

**Average velocity of increments 2-6:** 8203 m/s

## DETONATION VELOCITY DATA

**Material:** 83.3 wt% RDX/16.7 wt% Teflon

**Experimenter:** J. B. Panowski    **Date:** June 30, 1954

**Shot no.:** GMX-2-307-A; GMX-8-B-3255

**Diameter:** 1.625 in.    **Average density:** 1.833 g/cm<sup>3</sup>    **Voids:** ~1.5%

**Booster:** 1E15 detonator and P-016 lens

<u>Increment no.</u>	<u>Length (in.)</u>	<u>Density (g/cm<sup>3</sup>)</u>	<u>Velocity (m/s)</u>
1	4.000	1.831	---
2	2.000	1.834	8201
3	2.000	1.834	8225
4	2.000	1.834	8224
5	2.000	1.831	8233
6	2.000	1.833	8184

**Average velocity of increments 2-6:** 8213 m/s

**DETONATION VELOCITY DATA**

**Material:** 85 wt% RDX/14 wt% Teflon/1 wt% rubber

**Experimenter:** F. DuBois      **Date:** November 30, 1953

**Shot no.:** GMX-2-107-A; GMX-8-B-2911

**Diameter:** 1 in.      **Average density:** 1.665 g/cm<sup>3</sup>      **Voids:** 9.2%

**Fabrication:** Roll-milled and pressed

**Booster:** 1E15 detonator and Comp B

<u>Increment no.</u>	<u>Length (in.)</u>	<u>Density (g/cm<sup>3</sup>)</u>	<u>Velocity (m/s)</u>
1	0.998	1.664	---
2	0.998	1.665	7709
3	0.998	1.666	7728
4	0.998	1.663	7735
5	0.997	1.666	7739

**Average velocity of increments 2-5:** 7728 m/s

DETONATION VELOCITY DATA

**Material:** 85.1 wt% RDX/14.9 wt% TNT

**Experimenter:** E. James, Jr.      **Date:** March 11, 1954

**Shot no.:** GMX-2-212-3; GMX-8-B-3104

**Diameter:** 1.625 in.      **Average density:** 1.737 g/cm<sup>3</sup>      **Voids:** 2.8%

**Booster:** 1E15 detonator

<u>Increment no.</u>	<u>Length (in.)</u>	<u>Density (g/cm<sup>3</sup>)</u>	<u>Velocity (m/s)</u>
1	---	---	---
2	3.500	1.735	8351
3	3.625	1.741	8358
4	3.625	1.740	8344
5	3.625	1.734	8352

**Average velocity of increments 2-5:** 8351 m/s

**DETONATION VELOCITY DATA**

**Material:** 85 wt% RDX/15 wt% TNT

**Experimenter:** R. K. Rohwer      **Date:** June 5, 1951

**Shot no.:** GMX-2-2101-2100-1899-1898; GMX-8-FL-4494

**Diameter:** 1.5 in.      **Average density:** 1.7520 g/cm<sup>3</sup>

**Booster:** 1E15 detonator and P-015 lens

<u>Increment no.</u>	<u>Length (in.)</u>	<u>Velocity (m/s)</u>
1	1.009	---
2	1.009	8431
3	1.009	8348
4	1.009	8515

**Average velocity of increments 2-4:** 8431 m/s

DETONATION VELOCITY DATA

**Material:** 85 wt% RDX/15 wt% TNT

**Experimenter:** E. James, Jr.    **Date:** March 11, 1954

**Shot no.:** GMX-2-212-5; GMX-8-B-3103

**Diameter:** 1.625 in.    **Average density:** 1.733 g/cm<sup>3</sup>    **Voids:** 2.9%

**Booster:** 1E15 detonator

<u>Increment no.</u>	<u>Length (in.)</u>	<u>Density (g/cm<sup>3</sup>)</u>	<u>Velocity (m/s)</u>
1	3.500	---	--
2	3.500	1.736	8354
3	3.500	1.736	8362
4	3.500	1.734	8352
5	3.500	1.727	8333

**Average velocity of increments 2-5:** 8350 m/s

DETONATION VELOCITY DATA

Material: 85 wt% RDX/15 wt% TNT

Experimenter: R. K. Rohwer Date: June 5, 1951

Shot no.: GMX-2-1892, -93, -94, -97; GMX-8-FL-4495

Diameter: 1.5 in. Average density: 1.7520 g/cm<sup>3</sup>

Booster: 1E15 detonator and P-015 lens

<u>Increment no.</u>	<u>Length (in.)</u>	<u>Velocity (m/s)</u>
1	1.009	---
2	1.009	8403
3	1.010	8328
4	1.009	8348

Average velocity of increments 2-4: 8360 m/s

DETONATION VELOCITY DATA

**Material:** 85 wt% RDX/15 wt% TNT

**Experimenter:** R. K. Rohwer      **Date:** June 5, 1951

**Shot no.:** GMX-2-2103, -2104, -2105, -2106; GMX-8-FL-4496

**Diameter:** 1.5 in.      **Average density:** 1.7520 g/cm<sup>3</sup>

**Booster:** 1E15 detonator and P-015 lens

<u>Increment no.</u>	<u>Length (in.)</u>	<u>Velocity (m/s)</u>
1	1.009	---
2	1.011	---
3	1.011	8392
4	1.010	8382

**Average velocity of increments 3 and 4:** 8387 m/s



DETONATION VELOCITY DATA

Material: 80 wt% RDX/20 wt% TNT

Experimenter: M. J. Urizar Date: June 22, 1954

Shot no.: GMX-2-302-2; GMX-8-D-4632

Diameter: 0.75 in. Average density: 1.200 g/cm<sup>3</sup> Voids: 32.4%

Fabrication: Pressed into tubes Confinement: 0.085-in. polystyrene

Booster: 1E15 detonator and P-016 lens

<u>Increment no.</u>	<u>Length (in.)</u>	<u>Density (g/cm<sup>3</sup>)</u>	<u>Velocity (m/s)</u>
1	3.000	1.200	---
2	3.000	1.201	6510
3	3.000	1.200	6460
4	3.000	1.200	6472

Average velocity of increments 2-4: 6481 m/s

DETONATION VELOCITY DATA

**Material:** 80 wt% RDX/20 wt% TNT

**Experimenter:** M. J. Urizar     **Date:** June 22, 1954

**Shot no.:** GMX-2-302-1; GMX-8-D-4631

**Diameter:** 0.75 in.     **Average density:** 1.201 g/cm<sup>3</sup>     **Voids:** 32.4%

**Fabrication:** Pressed into tubes     **Confinement:** 0.085-in. polystyrene

**Booster:** 1E15 detonator

<u>Increment no.</u>	<u>Length (in.)</u>	<u>Density (g/cm<sup>3</sup>)</u>	<u>Velocity (m/s)</u>
1	3.000	1.200	---
2	3.000	1.201	6487
3	3.000	1.200	6508
4	3.000	1.201	6471

**Average velocity of increments 2-4:** 6489 m/s

DETONATION VELOCITY DATA

**Material:** 80 wt% RDX/20 wt% TNT

**Experimenter:** M. J. Urizar      **Date:** September 3, 1954

**Shot no.:** GMX-2-368-A; GMX-8-B-3292

**Diameter:** 0.75 in.      **Average density:** 1.200 g/cm<sup>3</sup>      **Voids:** 32.4%

**Fabrication:** Pressed into tubes      **Confinement:** 0.085-in. polystyrene

**Booster:** 1E15 detonator

<u>Increment no.</u>	<u>Length (in.)</u>	<u>Density (g/cm<sup>3</sup>)</u>	<u>Velocity (m/s)</u>
1	3.000	1.198	---
2	3.000	1.199	--
3	3.000	1.200	6495
4	3.000	1.201	6507

**Average velocity of increments 3 and 4:** 6501 m/s

DETONATION VELOCITY DATA

**Material:** 80 wt% RDX/20 wt% TNT

**Experimenter:** M. J. Urizar      **Date:** June 22, 1954

**Shot no.:** GMX-2-302-4; GMX-8-D-4634

**Diameter:** 1 in.      **Average density:** 1.200 g/cm<sup>3</sup>      **Voids:** 32.4%

**Fabrication:** Pressed into tubes      **Confinement:** 0.085-in. polystyrene

**Booster:** 1E15 detonator

<u>Increment no.</u>	<u>Length (in.)</u>	<u>Density (g/cm<sup>3</sup>)</u>	<u>Velocity (m/s)</u>
1	3.000	1.200	---
2	3.000	1.200	6496
3	3.000	1.200	6489
4	3.000	1.200	6490

**Average velocity of increments 2-4:** 6492 m/s

DETONATION VELOCITY DATA

**Material:** 80 wt% RDX/20 wt% TNT

**Experimenter:** M. J. Urizar      **Date:** June 22, 1954

**Shot no.:** GMX-2-302-3; GMX-8-D-4633

**Diameter:** 1 in.      **Average density:** 1.200 g/cm<sup>3</sup>      **Voids:** 32.4%

**Fabrication:** Pressed into tubes      **Confinement:** 0.085-in. polystyrene

**Booster:** 1E15 detonator

<u>Increment no.</u>	<u>Length (in.)</u>	<u>Density (g/cm<sup>3</sup>)</u>	<u>Velocity (m/s)</u>
1	3.000	1.200	---
2	3.000	1.200	6501
3	3.000	1.200	6492
4	3.000	1.200	6485

**Average velocity of increments 2-4:** 6493 m/s

DETONATION VELOCITY DATA

**Material:** 80 wt% RDX/20 wt% TNT

**Experimenter:** M. J. Urizar      **Date:** September 8, 1954

**Shot no.:** GMX-2-368-B; GMX-8-B-3290

**Diameter:** 1.0 in.      **Average density:** 1.200 g/cm<sup>3</sup>      **Voids:** 32.4%

**Fabrication:** Pressed into tubes      **Confinement:** 0.085-in. polystyrene

**Booster:** 1E15 detonator

<u>Increment no.</u>	<u>Length (in.)</u>	<u>Density (g/cm<sup>3</sup>)</u>	<u>Velocity (m/s)</u>
1	3.000	1.199	---
2	3.000	1.200	6511
3	3.000	1.200	6522
4	3.000	1.201	6508

**Average velocity of increments 2-4:** 6514 m/s

DETONATION VELOCITY DATA

**Material:** 80 wt% RDX/20 wt% TNT

**Experimenter:** M. J. Urizar      **Date:** September 8, 1954

**Shot no.:** GMX-2-368-C; GMX-8-D-3288

**Diameter:** 1.5 in.      **Average density:** 1.200 g/cm<sup>3</sup>      **Voids:** 32.4%

**Fabrication:** Pressed into tubes      **Confinement:** 0.085-in. polystyrene

**Booster:** 1E15 detonator

<u>Increment no.</u>	<u>Length (in.)</u>	<u>Density (g/cm<sup>3</sup>)</u>	<u>Velocity (m/s)</u>
1	3.000	1.200	---
2	3.000	1.200	6520
3	3.000	1.200	6539
4	3.000	1.200	6534

**Average velocity of increments 2-4:** 6531 m/s

DETONATION VELOCITY DATA

**Material:** 80 wt% RDX/20 wt% TNT

**Experimenter:** M. J. Urizar      **Date:** June 22, 1954

**Shot no.:** GMX-2-302-5; GMX-8-D-4635

**Diameter:** 1.5 in.      **Average density:** 1.199 g/cm<sup>3</sup>      **Voids:** 32.4%

**Fabrication:** Pressed into tubes      **Confinement:** 0.085-in. polystyrene

**Booster:** 1E15 detonator

<u>Increment no.</u>	<u>Length (in.)</u>	<u>Density (g/cm<sup>3</sup>)</u>	<u>Velocity (m/s)</u>
1	3.000	1.199	---
2	3.000	1.199	6552
3	3.000	1.199	6537
4	3.000	1.200	6509

**Average velocity of increments 2-4:** 6533 m/s



DETONATION VELOCITY DATA

**Material:** 80 wt% RDX/20 wt% TNT

**Experimenter:** M. J. Urizar      **Date:** June 22, 1954

**Shot no.:** GMX-2-302-6; GMX-8-D-4636

**Diameter:** 1.5 in.      **Average density:** 1.199 g/cm<sup>3</sup>      **Voids:** 32.4%

**Fabrication:** Pressed into tubes      **Confinement:** 0.085-in. polystyrene

**Booster:** 1E15 detonator and P-016 lens

<u>Increment no.</u>	<u>Length (in.)</u>	<u>Density (g/cm<sup>3</sup>)</u>	<u>Velocity (m/s)</u>
1	3.000	1.200	---
2	3.000	1.199	6559
3	3.000	1.199	6547
4	3.000	1.199	6526

**Average velocity of increments 2-4:** 6544 m/s

DETONATION VELOCITY DATA

**Material:** 78.1 wt% RDX/21.9 wt% TNT

**Experimenter:** M. J. Urizar      **Date:** January 14, 1954

**Shot no.:** GMX-2-129; GMX-8-D-4345

**Diameter:** 2 in.      **Average density:** 1.200 g/cm<sup>3</sup>      **Voids:** ~30%

**Fabrication:** Pressed into brass      **Confinement:** 0.5-in. wall brass

**Booster:** 1E15 detonator and Comp B

<u>Increment no.</u>	<u>Length (in.)</u>	<u>Density (g/cm<sup>3</sup>)</u>	<u>Velocity (m/s)</u>
1	2.000	1.200	---
2	2.000	1.200	---
3	2.000	1.200	6449
4	2.000	1.200	6482
5	2.000	1.200	6463
6	2.000	1.200	6468
7	2.000	1.200	6465
8	2.000	1.200	6470

**Average velocity of increments 3-8:** 6466 m/s

DETONATION VELOCITY DATA

**Material:** 78.1 wt% RDX/21.9 wt% TNT

**Experimenter:** M. J. Urizar      **Date:** January 14, 1954

**Shot no.:** GMX-2-137; GMX-8-D-4347

**Diameter:** 2 in.      **Average density:** 1.200 g/cm<sup>3</sup>      **Voids:** 30%

**Fabrication:** Pressed into brass      **Confinement:** 0.5-in. wall brass

**Booster:** 1E15 detonator and Comp B

<u>Increment no.</u>	<u>Length (in.)</u>	<u>Density (g/cm<sup>3</sup>)</u>	<u>Velocity (m/s)</u>
1	2.000	1.200	---
2	2.000	1.201	---
3	2.000	1.200	6476
4	2.000	1.200	6450
5	2.000	1.200	6463
6	2.000	1.201	6496
7	2.000	1.200	6461
8	2.000	1.200	6466

**Average velocity of increments 3-8:** 6469 m/s

DETONATION VELOCITY DATA

**Material:** 80 wt% RDX/20 wt% TNT

**Experimenter:** M. J. Urizar      **Date:** June 22, 1954

**Shot no.:** GMX-2-302-7; GMX-8-D-4637

**Diameter:** 3 in.      **Average density:** 1.201 g/cm<sup>3</sup>      **Voids:** 32.4%

**Fabrication:** Pressed into tubes      **Confinement:** 0.085-in. polystyrene

**Booster:** 1E15 detonator and P-040 lens

<u>Increment no.</u>	<u>Length (in.)</u>	<u>Density (g/cm<sup>3</sup>)</u>	<u>Velocity (m/s)</u>
1	6.000	1.199	--
2	6.000	1.201	6581
3	6.000	1.201	6576
4	6.000	1.201	6527

**Average velocity of increments 2-4:** 6561 m/s

DETONATION VELOCITY DATA

**Material:** 80 wt% RDX/20 wt% TNT

**Experimenter:** M. J. Urizar      **Date:** June 22, 1954

**Shot no.:** GMX-2-302-8; GMX-8-D-4638

**Diameter:** 3 in.      **Average density:** 1.200 g/cm<sup>3</sup>      **Voids:** 32.4%

**Fabrication:** Pressed into tubes      **Confinement:** 0.085-in. polystyrene

**Booster:** 1E15 detonator

<u>Increment no.</u>	<u>Length (in.)</u>	<u>Density (g/cm<sup>3</sup>)</u>	<u>Velocity (m/s)</u>
1	6.000	1.200	---
2	6.000	1.200	6580
3	6.000	1.200	6557
4	6.000	1.200	6547

**Average velocity of increments 2-4:** 6561 m/s

## DETONATION VELOCITY DATA

**Material:** 80 wt% RDX/20 wt% TNT

**Experimenter:** M. J. Urizar     **Date:** September 8, 1954

**Shot no.:** GMX-2-368-D; GMX-8-B-3285

**Diameter:** 3 in.     **Average density:** 1.200 g/cm<sup>3</sup>     **Voids:** 32.4%

**Fabrication:** Pressed into tubes     **Confinement:** 0.085-in. polystyrene

**Booster:** 1E15 detonator

<u>Increment no.</u>	<u>Length (in.)</u>	<u>Density (g/cm<sup>3</sup>)</u>	<u>Velocity (m/s)</u>
1	6.000	1.199	---
2	6.000	1.200	6563
3	6.000	1.200	6570
4	6.000	1.200	6554

**Average velocity of increments 2-4:** 6562 m/s

**DETONATION VELOCITY DATA**

**Material:** 78.1 wt% RDX/21.9 wt% TNT

**Experimenter:** M. J. Urizar      **Date:** January 18, 1954

**Shot no.:** GMX-2-141; GMX-8-D-4342

**Diameter:** 4 in.      **Average density:** 1.200 g/cm<sup>3</sup>      **Voids:** 30%

**Fabrication:** Pressed into brass      **Confinement:** 1-in. wall brass

**Booster:** 1E15 detonator and Comp B

<u>Increment no.</u>	<u>Length (in.)</u>	<u>Density (g/cm<sup>3</sup>)</u>	<u>Velocity (m/s)</u>
1	4.000	1.200	---
2	4.000	1.200	---
3	4.000	1.200	6514
4	4.000	1.200	6469
5	4.000	1.200	6497
6	4.000	1.200	6499
7	4.000	1.200	6518
8	4.000	1.200	6511

**Average velocity of increments 3-8:** 6501 m/s

## DETONATION VELOCITY DATA

**Material:** 78.1 wt% RDX/21.9 wt% TNT

**Experimenter:** M. J. Urizar      **Date:** January 18, 1954

**Shot no.:** GMX-2-140; GMX-8-D-4341

**Diameter:** 4 in.      **Average density:** 1.200 g/cm<sup>3</sup>      **Voids:** 30%

**Fabrication:** Pressed into brass      **Confinement:** 1-in. wall brass

**Booster:** 1E15 detonator and Comp B

<u>Increment no.</u>	<u>Length (in.)</u>	<u>Density (g/cm<sup>3</sup>)</u>	<u>Velocity (m/s)</u>
1	4.000	1.200	---
2	4.000	1.200	---
3	4.000	1.200	6511
4	4.000	1.200	6491
5	4.000	1.200	6510
6	4.000	1.200	6499
7	4.000	1.200	6495
8	4.000	1.200	6507

**Average velocity of increments 3-8:** 6502 m/s



DETONATION VELOCITY DATA

Material: 60 wt% RDX/40 wt% TNT

Experimenter: M. J. Urizar Date: June 22, 1954

Shot no.: GMX-2-301-2; GMX-8-D-4630

Diameter: 0.75 in. Average density: 1.200 g/cm<sup>3</sup> Voids: 31.2%

Fabrication: Pressed into tubes Confinement: 0.085-in. polystyrene

Booster: 1E15 detonator

<u>Increment no.</u>	<u>Length (in.)</u>	<u>Density (g/cm<sup>3</sup>)</u>	<u>Velocity (m/s)</u>
1	3.000	1.200	---
2	3.000	1.200	6275
3	3.000	1.201	6255
4	3.000	1.201	6251

Average velocity of increments 2-4: 6260 m/s

DETONATION VELOCITY DATA

**Material:** 60 wt% RDX/40 wt% TNT

**Experimenter:** M. J. Urizar      **Date:** June 22, 1954

**Shot no.:** GMX-2-301-1; GMX-8-D-4629

**Diameter:** 0.75 in.      **Average density:** 1.201 g/cm<sup>3</sup>      **Voids:** 31.2%

**Fabrication:** Pressed into tubes      **Confinement:** 0.085-in. polystyrene

**Booster:** 1E15 detonator

<u>Increment no.</u>	<u>Length (in.)</u>	<u>Density (g/cm<sup>3</sup>)</u>	<u>Velocity (m/s)</u>
1	3.000	1.200	---
2	3.000	1.201	6287
3	3.000	1.201	6279
4	3.000	1.201	6241

**Average velocity of increments 2-4:** 6269 m/s

DETONATION VELOCITY DATA

**Material:** 60 wt% RDX/40 wt% TNT

**Experimenter:** M. J. Urizar      **Date:** June 22, 1954

**Shot no.:** GMX-2-301-3; GMX-8-D-4628

**Diameter:** 1 in.      **Average density:** 1.201 g/cm<sup>3</sup>      **Voids:** 31.2%

**Fabrication:** Pressed into tubes      **Confinement:** 0.085-in. polystyrene

**Booster:** 1E15 detonator and P-016 lens

<u>Increment no.</u>	<u>Length (in.)</u>	<u>Density (g/cm<sup>3</sup>)</u>	<u>Velocity (m/s)</u>
1	3.000	1.201	---
2	3.000	1.201	6298
3	3.000	1.201	6282
4	3.000	1.200	6270

**Average velocity of increments 2-4:** 6283 m/s

DETONATION VELOCITY DATA

**Material:** 60 wt% RDX/40 wt% TNT

**Experimenter:** M. J. Urizar      **Date:** June 22, 1954

**Shot no.:** GMX-2-301-4; GMX-8-D-4627

**Diameter:** 1 in.      **Average density:** 1.201 g/cm<sup>3</sup>      **Voids:** 31.2%

**Fabrication:** Pressed into tubes      **Confinement:** 0.085-in. polystyrene

**Booster:** 1E15 detonator

<u>Increment no.</u>	<u>Length (in.)</u>	<u>Density (g/cm<sup>3</sup>)</u>	<u>Velocity (m/s)</u>
1	3.000	1.201	--
2	3.000	1.201	6293
3	3.000	1.201	6283
4	3.000	1.201	6275

**Average velocity of increments 2-4:** 6284 m/s

DETONATION VELOCITY DATA

**Material:** 60 wt% RDX/40 wt% TNT

**Experimenter:** M. J. Urizar      **Date:** June 22, 1954

**Shot no.:** GMX-2-301-6; GMX-8-D-4626

**Diameter:** 1.5 in.      **Average density:** 1.200 g/cm<sup>3</sup>      **Voids:** 31.2%

**Fabrication:** Pressed into tubes      **Confinement:** 0.085-in. polystyrene

**Booster:** 1E15 detonator and P-016 lens

<u>Increment no.</u>	<u>Length (in.)</u>	<u>Density (g/cm<sup>3</sup>)</u>	<u>Velocity (m/s)</u>
1	3.000	1.200	---
2	3.000	1.200	6384
3	3.000	1.200	6313
4	3.000	1.200	6297

**Average velocity of increments 2-4:** 6331 m/s

DETONATION VELOCITY DATA

**Material:** 60 wt% RDX/40 wt% TNT

**Experimenter:** M. J. Urizar      **Date:** June 22, 1954

**Shot no.:** GMX-2-301-5; GMX-8-D-4625

**Diameter:** 1.5 in.      **Average density:** 1.200 g/cm<sup>3</sup>      **Voids:** 31.2%

**Fabrication:** Pressed into tubes      **Confinement:** 0.085-in. polystyrene

**Booster:** 1E15 detonator and P-016 lens

<u>Increment no.</u>	<u>Length (in.)</u>	<u>Density (g/cm<sup>3</sup>)</u>	<u>Velocity (m/s)</u>
1	3.000	1.200	---
2	3.000	1.200	6350
3	3.000	1.200	6347
4	3.000	1.200	---

**Average velocity of increments 2 and 3:** 6349 m/s

DETONATION VELOCITY DATA

**Material:** 60 wt% RDX/40 wt% TNT

**Experimenter:** M. J. Urizar      **Date:** June 22, 1954

**Shot no.:** GMX-2-301-8; GMX-8-D-4624

**Diameter:** 3 in.      **Average density:** 1.201 g/cm<sup>3</sup>      **Voids:** 31.2%

**Fabrication:** Pressed into tubes      **Confinement:** 0.085-in. polystyrene

**Booster:** 1E15 detonator

<u>Increment no.</u>	<u>Length (in.)</u>	<u>Density (g/cm<sup>3</sup>)</u>	<u>Velocity (m/s)</u>
1	6.000	1.201	--
2	6.000	1.201	6385
3	6.000	1.201	6372
4	6.000	1.201	6342

**Average velocity of increments 2-4:** 6366 m/s

DETONATION VELOCITY DATA

**Material:** 60 wt% RDX/40 wt% TNT

**Experimenter:** M. J. Urizar      **Date:** June 22, 1954

**Shot no.:** GMX-2-301-7; GMX-8-D-4623

**Diameter:** 3 in.      **Average density:** 1.201 g/cm<sup>3</sup>      **Voids:** 31.2%

**Fabrication:** Pressed into tubes      **Confinement:** 0.085-in. polystyrene

**Booster:** 1E15 detonator

<u>Increment no.</u>	<u>Length (in.)</u>	<u>Density (g/cm<sup>3</sup>)</u>	<u>Velocity (m/s)</u>
1	6.000	1.201	--
2	6.000	1.201	6396
3	6.000	1.201	6370
4	6.000	1.201	6355

**Average velocity of increments 2-4:** 6374 m/s



DETONATION VELOCITY DATA

**Material:** 70 wt% RDX/30 wt% zirconium hydride

**Experimenter:** F. DuBois and K. Fess      **Date:** August 11, 1951

**Shot no.:** GMX-2-825B (1); GMX-8-FL-4845

**Diameter:** 1.024 in.      **Average density:** 2.1917 g/cm<sup>3</sup>

**Booster:** 1E15 detonator, P-040 lens, and 1-in. Comp B

**Average velocity of increments:** 7280 m/s

**Material:** 63.3 wt% RDX/29.9 wt% zirconium hydride/5.3 wt% PS/1.5 wt% DOP

**Experimenter:** F. DuBois      **Date:** December 17, 1953

**Shot no.:** GMX-2-113; GMX-8-FL-7492

**Diameter:** 1.625 in.      **Average density:** 2.087 g/cm<sup>3</sup>      **Voids:** ~0.5%

**Fabrication:** Vacuum pressed

**Booster:** 1E15 detonator and Comp B

<u>Increment no.</u>	<u>Length (in.)</u>	<u>Density (g/cm<sup>3</sup>)</u>	<u>Velocity (m/s)</u>
1	3.503	2.085	---
2	3.502	2.088	7395
3	3.504	2.088	7369
4	3.503	2.088	7350

**Average velocity of increments 2-4:** 7371 m/s

DETONATION VELOCITY DATA

**Material:** 61 wt% RDX/32.9 wt% zirconium hydride/4.8 wt% PS/1.3 wt% DOP

**Experimenter:** F. DuBois      **Date:** March 8, 1954

**Shot no.:** GMX-2-209; GMX-8-B-3102

**Diameter:** 1.625 in.      **Average density:** 2.148 g/cm<sup>3</sup>      **Voids:** 2.4%

**Fabrication:** Vacuum pressed

**Booster:** 1E15 detonator and Comp B

<u>Increment no.</u>	<u>Length (in.)</u>	<u>Density (g/cm<sup>3</sup>)</u>	<u>Velocity (m/s)</u>
1	4.000	2.146	---
2	4.000	2.148	7305
3	4.000	2.147	7289
4	4.000	2.148	7314
5	4.000	2.148	7289
6	4.000	2.148	7295

**Average velocity of increments 2-6:** 7298 m/s

DETONATION VELOCITY DATA

Material: TATB

Experimenter: M. J. Urizar Date: September 28, 1964

Shot no.: GMX-2-1662-A; GMX-8-E-1986

Diameter: 1 in. Average density: 1.862 g/cm<sup>3</sup> Voids: ~3%

Fabrication: Pressed

<u>Increment no.</u>	<u>Length (in.)</u>	<u>Density (g/cm<sup>3</sup>)</u>
1	0.9959	1.783
2	1.0041	1.855
3	1.0075	1.863
4	1.0278	1.867
5	1.0289	1.871
6	1.0380	1.877
7	1.0428	1.876
8	1.0388	1.876
9	1.0428	1.876
10	1.0429	1.876

Average velocity of increments 3-10: 7645 m/s

DETONATION VELOCITY DATA

**Material:** TATB

**Experimenter:** M. J. Urizar      **Date:** September 28, 1964

**Shot no.:** GMX-2-1662-B; GMX-8-E-1985

**Diameter:** 1 in.      **Average density:** 1.866 g/cm<sup>3</sup>      **Voids:** ~3%

<u>Increment no.</u>	<u>Length (in.)</u>	<u>Density (g/cm<sup>3</sup>)</u>
1	0.9981	1.820
2	0.9481	1.853
3	1.0412	1.863
4	1.0281	1.866
5	1.0340	1.878
6	1.0352	1.874
7	1.0427	1.875
8	1.0427	1.875
9	1.0428	1.877
10	1.0340	1.876

**Average velocity of increments 3-10:** 7672 m/s

DETONATION VELOCITY DATA

**Material:** TATB

**Experimenter:** M. J. Urizar      **Date:** September 28, 1964

**Shot no.:** GMX-2-1663-A; GMX-8-E-1991

**Diameter:** 2 in.      **Average density:** 1.870 g/cm<sup>3</sup>      **Voids:** ~3%

**Fabrication:** Pressed

<u>Increment no.</u>	<u>Length (in.)</u>	<u>Density (g/cm<sup>3</sup>)</u>
1	0.9792	1.879
2	0.9800	1.868
3	0.9701	1.877
4	0.9900	1.873
5	0.9955	1.876
6	0.9893	1.869
7	0.9798	1.876
8	0.9800	1.871
9	0.9900	1.875
10	0.9900	1.874
11	0.9801	1.873
12	0.9891	1.875
13	0.9899	1.873
14	0.9799	1.875
15	0.9898	1.874
16	0.9892	1.873
17	0.9800	1.875
18	0.9892	1.874
19	0.9798	1.874
20	0.9799	1.875

**Average velocity of increments 6-20:** 7724 m/s

DETONATION VELOCITY DATA

Material: TATB

Experimenter: M. J. Urizar      Date: October 22, 1964

Shot no.: GMX-2-1663-B; GMX-8-E-1993

Diameter: 2 in.      Average density: 1.874 g/cm<sup>3</sup>      Voids: ~3%

Fabrication: Pressed

<u>Increment no.</u>	<u>Length (in.)</u>	<u>Density (g/cm<sup>3</sup>)</u>
1	0.9815	1.879
2	1.8790	1.868
3	1.9810	1.875
4	1.9755	1.870
5	1.9810	1.875
6	0.9850	1.872
7	1.0000	1.878
8	0.9800	1.872
9	1.0000	1.876
10	0.9800	1.872
11	0.9848	1.875
12	0.9800	1.872
13	0.9900	1.875
14	0.9800	1.873
15	0.9800	1.874
16	0.9800	1.874
17	0.9800	1.874
18	0.9800	1.874
19	0.9850	1.875

Average velocity of increments 6-19: 7725 m/s

DETONATION VELOCITY DATA

**Material:** Tetryl

**Experimenter:** E. James, Jr.    **Date:** July 26, 1954

**Shot no.:** GMX-2-276-G; GMX-8-3264

**Diameter:** 0.250 in.    **Average density:** 1.687 g/cm<sup>3</sup>    **Voids:** ~1.4%

**Booster:** 1E15 detonator

<u>Increment no.</u>	<u>Length (in.)</u>	<u>Density (g/cm<sup>3</sup>)</u>	<u>Velocity (m/s)</u>
1	2.032	1.684	--
2	2.032	1.684	---
3	2.032	1.694	7548
4	2.032	1.692	7497
5	2.032	1.686	7513
6	2.032	1.681	7500
7	2.032	1.685	7507
8	2.032	1.683	7499

**Average velocity of increments 3-8:** 7511 m/s

DETONATION VELOCITY DATA

**Material:** Tetryl

**Experimenter:** E. James, Jr.    **Date:** July 26, 1954

**Shot no.:** GMX-2-276-F; GMX-8-3263

**Diameter:** 0.333 in.    **Average density:** 1.692 g/cm<sup>3</sup>    **Voids:** ~1.4%

**Booster:** 1E15 detonator

<u>Increment no.</u>	<u>Length (in.)</u>	<u>Density (g/cm<sup>3</sup>)</u>	<u>Velocity (m/s)</u>
1	2.032	1.690	---
2	2.032	1.689	--
3	2.032	1.694	7528
4	2.032	1.690	7516
5	2.032	1.695	7523
6	2.032	1.688	7518
7	2.032	1.693	7538
8	2.032	1.694	7521

**Average velocity of increments 2-8:** 7524 m/s



DETONATION VELOCITY DATA

**Material:** Tetryl

**Experimenter:** E. James, Jr.    **Date:** July 26, 1954

**Shot no.:** GMX-2-276-E; GMX-8-3262

**Diameter:** 0.400 in.    **Average density:** 1.694 g/cm<sup>3</sup>    **Voids:** ~1.4%

**Booster:** 1E15 detonator

<u>Increment no.</u>	<u>Length (in.)</u>	<u>Density (g/cm<sup>3</sup>)</u>	<u>Velocity (m/s)</u>
1	2.031	1.690	---
2	2.032	1.691	---
3	2.032	1.695	7547
4	2.032	1.695	7518
5	2.032	1.693	7537
6	2.032	1.694	7538
7	2.032	1.693	7529
8	2.032	1.696	7527

**Average velocity of increments 3-8:** 7533 m/s

DETONATION VELOCITY DATA

Material: Tetryl

Experimenter: E. James, Jr. Date: July 26, 1954

Shot no.: GMX-2-276-D; GMX-8-3260

Diameter: 0.500 in. Average density: 1.6892 g/cm<sup>3</sup> Voids: ~1.5%

Booster: 1E15 detonator

Increment no.	Length (in.)	Density (g/cm <sup>3</sup> )	Velocity (m/s)
1	2.032	1.697	---
2	2.032	1.681	---
3	2.032	1.685	7515
4	2.032	1.690	7521
5	2.032	1.694	7522
6	2.032	1.688	7510
7	2.032	1.696	7542
8	2.033	1.680	7500

Average velocity of increments 3-8: 7518 m/s

DETONATION VELOCITY DATA

**Material:** Tetryl

**Experimenter:** E. James, Jr.      **Date:** July 26, 1954

**Shot no.:** GMX-2-276-C; GMX-8-3259

**Diameter:** 0.667 in.      **Average density:** 1.687 g/cm<sup>3</sup>      **Voids:** ~1.5%

**Booster:** 1E15 detonator

<u>Increment no.</u>	<u>Length (in.)</u>	<u>Density (g/cm<sup>3</sup>)</u>	<u>Velocity (m/s)</u>
1	2.032	1.683	---
2	2.032	1.683	---
3	2.032	1.687	7543
4	2.032	1.681	7522
5	2.032	1.683	7509
6	2.032	1.686	7501
7	2.032	1.692	7529
8	2.032	1.692	7529

**Average velocity of increments 3-8:** 7522 m/s

DETONATION VELOCITY DATA

Material: Tetryl

Experimenter: E. James, Jr. Date: July 26, 1954

Shot no.: GMX-2-276-B; GMX-8-3258

Diameter: 1.000 in. Average density: 1.693 g/cm<sup>3</sup> Voids: ~1.4%

Booster: 1E15 detonator

<u>Increment no.</u>	<u>Length (in.)</u>	<u>Density (g/cm<sup>3</sup>)</u>	<u>Velocity (m/s)</u>
1	2.032	1.687	---
2	2.032	1.686	---
3	2.032	1.692	7528
4	2.032	1.694	7545
5	2.032	1.692	7539
6	2.032	1.693	7547
7	2.032	1.692	7536
8	2.032	1.692	7542

Average velocity of increments 3-8: 7540 m/s

DETONATION VELOCITY DATA

**Material:** Tetryl

**Experimenter:** E. James, Jr.      **Date:** July 26, 1954

**Shot no.:** GMX-2-276-A; GMX-8-B-3257

**Diameter:** 2.000 in.      **Average density:** 1.685 g/cm<sup>3</sup>      **Voids:** ~1.9%

**Booster:** 1E15 detonator

<u>Increment no.</u>	<u>Length (in.)</u>	<u>Density (g/cm<sup>3</sup>)</u>	<u>Velocity (m/s)</u>
1	2.031	1.683	---
2	2.032	1.684	---
3	2.032	1.684	7516
4	2.032	1.685	7509
5	2.032	1.686	7525
6	2.032	1.687	7514
7	2.031	1.684	7519
8	2.032	1.687	7522

**Average velocity of increments 3-8:** 7518 m/s

DETONATION VELOCITY DATA

**Material:** Atlas TNT

**Experimenter:** M. J. Urizar      **Date:** February 11, 1955

**Shot no.:** GMX-2-558-A and -B;    GMX-8-D-4965

**Diameter:** 0.75 in.      **Average density:** 0.900 g/cm<sup>3</sup>      **Voids:** 45.5%

**Fabrication:** Pressed into tubes      **Confinement:** 0.25-in. wall Dural

**Booster:** 1E15 detonator and Comp B

<u>Increment no.</u>	<u>Length (in.)</u>	<u>Density (g/cm<sup>3</sup>)</u>	<u>Velocity (m/s)</u>
1	3.000	0.901	---
2	3.001	0.900	4605
3	3.000	0.900	4604
4	3.001	0.900	4594
5	3.001	0.901	4588
6	3.001	0.900	4589
7	3.001	0.900	4597
8	3.000	0.900	4593

**Average velocity of increments 2-8:** 4596 m/s

**DETONATION VELOCITY DATA**

**Material:** Atlas TNT

**Experimenter:** M. J. Urizar    **Date:** September 15, 1955

**Shot no.:** GMX-2-782; GMX-8-B-3760

**Diameter:** 0.7683 in.    **Average density:** 0.900 g/cm<sup>3</sup>    **Voids:** 45.6%

**Fabrication:** Pressed into tubes    **Confinement:** 0.2-in. wall brass

**Booster:** 1E15 detonator and Comp B

<u>Increment no.</u>	<u>Length (in.)</u>	<u>Density (g/cm<sup>3</sup>)</u>	<u>Velocity (m/s)</u>
1	3.000	0.900	---
2	3.000	0.900	4598
3	3.000	0.900	4600
4	3.000	0.900	4586
5	2.9985	0.902	4587
6	2.9994	0.898	4586
7	3.000	0.900	4589
8	3.000	0.900	4610
9	3.000	0.901	4592

**Average velocity of increments 2-9:** 4594 m/s

DETONATION VELOCITY DATA

**Material:** Atlas TNT

**Experimenter:** M. J. Urizar      **Date:** February 25, 1955

**Shot no.:** GMX-2-560-A; GMX-8-B-3518

**Diameter:** 1 in.      **Average density:** 0.900 g/cm<sup>3</sup>      **Voids:** 45.5%

**Fabrication:** Pressed into tubes      **Confinement:** 0.25-in. wall Dural

**Booster:** 1E15 detonator and Comp B

<u>Increment no.</u>	<u>Length (in.)</u>	<u>Density (g/cm<sup>3</sup>)</u>	<u>Velocity (m/s)</u>
1	3.001	0.900	4639
2	3.001	0.900	4633
3	3.001	0.900	4644
4	3.001	0.900	4653
5	3.001	0.900	4653
6	3.001	0.900	4619
7	3.000	0.900	4622
8	3.001	0.900	4663

**Average velocity of increments 1-8:** 4641 m/s



DETONATION VELOCITY DATA

Material: Atlas TNT

Experimenter: M. J. Urizar Date: September 15, 1955

Shot no.: GMX-2-783; GMX-8-B-3759

Diameter: 1.025 in. Average density: 0.900 g/cm<sup>3</sup> Voids: 45.6%

Booster: 1E15 detonator and Comp B

<u>Increment no.</u>	<u>Length (in.)</u>	<u>Density (g/cm<sup>3</sup>)</u>	<u>Velocity (m/s)</u>
1	2.9998	0.901	---
2	3.000	0.900	4632
3	3.000	0.901	4636
4	2.9998	0.901	4643
5	2.9995	0.899	4626
6	2.9998	0.900	4639
7	2.9998	0.900	4623
8	2.9998	0.900	4632
9	3.000	0.900	4627

Average velocity of increments 2-9: 4632 m/s

## DETONATION VELOCITY DATA

**Material:** Atlas TNT

**Experimenter:** M. J. Urizar    **Date:** February 8, 1955

**Shot no.:** GMX-2-557-B; GMX-8-D-4960

**Diameter:** 1.5 in.    **Average density:** 0.900 g/cm<sup>3</sup>    **Voids:** 45.6%

**Fabrication:** Pressed into tubes    **Confinement:** 0.25-in. wall Dural

**Booster:** 1E15 detonator and TNT

<u>Increment no.</u>	<u>Length (in.)</u>	<u>Density (g/cm<sup>3</sup>)</u>	<u>Velocity (m/s)</u>
1	3.002	0.899	---
2	3.001	0.900	4748
3	3.001	0.900	4625
4	3.001	0.900	4756

**Average velocity of increments 2-4:** 4710 m/s

**DETONATION VELOCITY DATA**

**Material:** Atlas TNT

**Experimenter:** M. J. Urizar      **Date:** September 13, 1955

**Shot no.:** GMX-2-780; GMX-8-B-3756

**Diameter:** 1.538 in.      **Average density:** 0.900 g/cm<sup>3</sup>      **Voids:** 45.6%

**Fabrication:** Pressed into tubes

**Booster:** 1E15 detonator and Comp B

<u>Increment no.</u>	<u>Length (in.)</u>	<u>Density (g/cm<sup>3</sup>)</u>	<u>Velocity (m/s)</u>
1	3.0006	0.900	---
2	3.0003	0.901	4680
3	3.0006	0.900	4673
4	3.001	0.900	4666
5	3.0004	0.900	4657
6	3.0007	0.900	4667
7	3.0006	0.901	4665
8	3.0002	0.900	4662
9	3.001	0.900	4655

**Average velocity of increments 2-9:** 4666 m/s

DETONATION VELOCITY DATA

**Material:** Atlas TNT

**Experimenter:** M. J. Urizar      **Date:** March 28, 1955

**Shot no.:** GMX-2-672-B; GMX-8-B-3563

**Diameter:** 3 in.      **Average density:** 0.900 g/cm<sup>3</sup>      **Voids:** 45.6%

**Fabrication:** Pressed into tubes

**Booster:** 1E15 detonator and Comp B

<u>Increment no.</u>	<u>Length (in.)</u>	<u>Density (g/cm<sup>3</sup>)</u>	<u>Velocity (m/s)</u>
1	6.002	0.901	---
2	6.000	0.900	---
3	6.000	0.900	4750
4	6.001	0.900	4753
5	6.001	0.900	4753
6	6.001	0.900	4755
7	6.002	0.900	4756
8	6.000	0.900	4756
9	6.000	0.901	4754

**Average velocity of increments 3-9:** 4754 m/s

DETONATION VELOCITY DATA

Material: Atlas TNT

Experimenter: M. J. Urizar Date: September 14, 1955

Shot no.: GMX-2-781; GMX-8-B-3758

Diameter: 3.077 in. Average density: 0.900 g/cm<sup>3</sup> Voids: 45.6%

Fabrication: Pressed into tubes Confinement: 0.2-in. wall brass

Booster: 1E15 detonator and Comp B

<u>Increment no.</u>	<u>Length (in.)</u>	<u>Density (g/cm<sup>3</sup>)</u>	<u>Velocity (m/s)</u>
1	6.0002	0.900	---
2	5.9996	0.900	4712
3	6.0002	0.900	4708
4	6.000	0.901	4720
5	6.0004	0.900	4708
6	6.0005	0.899	4717
7	6.000	0.900	4711
8	6.0007	0.901	4718
9	6.000	0.900	4709

Average velocity of increments 2-9: 4713 m/s

## DETONATION VELOCITY DATA

**Material:** Atlas TNT

**Experimenter:** M. J. Urizar      **Date:** September 6, 1955

**Shot no.:** GMX-2-777; GMX-8-B-3748

**Diameter:** 0.7683 in.      **Average density:** 1.051 g/cm<sup>3</sup>      **Voids:** 12.3%

**Fabrication:** Pressed into tubes      **Confinement:** 0.2-in. wall brass

**Booster:** 1E15 detonator and Comp B

<u>Increment no.</u>	<u>Length (in.)</u>	<u>Density (g/cm<sup>3</sup>)</u>	<u>Velocity (m/s)</u>
1	3.000	1.051	---
2	3.000	1.050	5076
3	3.000	1.051	5043
4	3.000	1.051	5054
5	3.000	1.051	5078
6	3.000	1.050	5057
7	3.000	1.050	5060
8	3.000	1.050	5033
9	3.000	1.050	5049

**Average velocity of increments 2-9:** 5056 m/s

DETONATION VELOCITY DATA

**Material:** Atlas TNT

**Experimenter:** M. J. Urizar      **Date:** September 6, 1955

**Shot no.:** GMX-2-776; GMX-8-B-3749

**Diameter:** 1.025 in.      **Average density:** 1.050 g/cm<sup>3</sup>      **Voids:** 12.3%

**Fabrication:** Pressed into tubes

**Booster:** 1E15 detonator and Comp B

<u>Increment no.</u>	<u>Length (in.)</u>	<u>Density (g/cm<sup>3</sup>)</u>	<u>Velocity (m/s)</u>
1	3.000	1.049	---
2	3.000	1.050	5100
3	3.000	1.050	5108
4	3.000	1.050	5107
5	3.000	1.050	5105
6	3.000	1.050	5097
7	3.000	1.050	5095
8	3.000	1.050	5104
9	3.000	1.050	5100

**Average velocity of increments 2-9:** 5102 m/s

DETONATION VELOCITY DATA

**Material:** Atlas TNT

**Experimenter:** M. J. Urizar      **Date:** September 8, 1955

**Shot no.:** GMX-2-778; GMX-8-B-3754

**Diameter:** 3.077 in.      **Average density:** 1.050 g/cm<sup>3</sup>      **Voids:** 12.3%

**Fabrication:** Pressed into tubes      **Confinement:** 0.2-in. wall brass

**Booster:** 1E15 detonator and Comp B

<u>Increment no.</u>	<u>Length (in.)</u>	<u>Density (g/cm<sup>3</sup>)</u>	<u>Velocity (m/s)</u>
1	6.000	1.051	---
2	6.001	1.050	5174
3	6.000	1.050	5175
4	6.000	1.051	5193
5	6.000	1.050	5181
6	6.001	1.051	5176
7	6.000	1.051	5183
8	6.000	1.050	5185
9	6.000	1.050	5175

**Average velocity of increments 2-9:** 5180 m/s



DETONATION VELOCITY DATA

Material: Atlas TNT

Experimenter: M. J. Urizar Date: March 9, 1955

Shot no.: GMX-2-651-C; GMX-8-B-3524

Diameter: 0.75 in. Average density: 1.199 g/cm<sup>3</sup> Voids: 37.4%

Fabrication: Pressed into tubes Confinement: 0.625-in. wall polystyrene

Booster: 1E15 detonator and Comp B

<u>Increment no.</u>	<u>Length (in.)</u>	<u>Density (g/cm<sup>3</sup>)</u>	<u>Velocity (m/s)</u>
1	3.001	1.197	---
2	3.001	1.199	5300
3	3.001	1.199	5273
4	3.001	1.201	5307
5	3.001	1.200	5302
6	3.001	1.199	5306

Average velocity of increments 2-6: 5298 m/s

DETONATION VELOCITY DATA

Material: Atlas TNT

Experimenter: M. J. Urizar Date: February 1, 1955

Shot no.: GMX-2-557-E; GMX-8-B-3500

Diameter: 0.75 in. Average density: 1.201 g/cm<sup>3</sup> Voids: 27.5%

Fabrication: Pressed into tubes Confinement: 0.25-in. wall brass

Booster: 1E15 detonator and TNT

<u>Increment no.</u>	<u>Length (in.)</u>	<u>Density (g/cm<sup>3</sup>)</u>	<u>Velocity (m/s)</u>
1	2.999	1.202	---
2	3.000	1.201	5499
3	3.000	1.201	5511
4	3.000	1.200	5522

Average velocity of increments 2-4: 5511 m/s

DETONATION VELOCITY DATA

**Material:** Atlas TNT

**Experimenter:** M. J. Urizar      **Date:** February 1, 1955

**Shot no.:** GMX-2-557-D; GMX-8-B-3501

**Diameter:** 0.75 in.      **Average density:** 1.200 g/cm<sup>3</sup>      **Voids:** 27.5%

**Fabrication:** Pressed into tubes      **Confinement:** 0.25-in. wall brass

**Booster:** 1E15 detonator and TNT

<u>Increment no.</u>	<u>Length (in.)</u>	<u>Density (g/cm<sup>3</sup>)</u>	<u>Velocity (m/s)</u>
1	3.001	1.200	---
2	3.000	1.201	5472
3	3.000	1.200	5531
4	3.000	1.200	5535

**Average velocity of increments 2-4:** 5513 m/s

DETONATION VELOCITY DATA

**Material:** Atlas TNT

**Experimenter:** M. J. Urizar      **Date:** February 1, 1955

**Shot no.:** GMX-2-557-F; GMX-8-B-3499

**Diameter:** 0.75 in.      **Average density:** 1.200 g/cm<sup>3</sup>      **Voids:** 27.5%

**Fabrication:** Pressed into tubes      **Confinement:** 0.25-in. wall brass

**Booster:** 1E15 detonator and TNT

<u>Increment no.</u>	<u>Length (in.)</u>	<u>Density (g/cm<sup>3</sup>)</u>	<u>Velocity (m/s)</u>
1	3.000	1.200	---
2	3.000	1.200	5491
3	3.000	1.200	5509
4	3.000	1.199	5541

**Average velocity of increments 2-4:** 5514 m/s

DETONATION VELOCITY DATA

Material: Atlas TNT

Experimenter: M. J. Urizar Date: March 10, 1955

Shot no.: GMX-2-562-B; GMX-8-B-3536

Diameter: 0.75 in. Average density: 1.198 g/cm<sup>3</sup> Voids: 27.5%

Fabrication: Pressed into tubes Confinement: 0.25-in. wall brass

Booster: 1E15 detonator and Comp B

<u>Increment no.</u>	<u>Length (in.)</u>	<u>Density (g/cm<sup>3</sup>)</u>	<u>Velocity (m/s)</u>
1	3.000	1.201	5520
2	3.000	1.198	5522
3	3.000	1.197	5520
4	3.000	1.197	5520
5	3.000	1.197	5521
6	3.000	1.198	5521
7	3.000	1.198	5526
8	3.000	1.198	5527
9	3.000	1.197	5524
10	3.000	1.196	5509

Average velocity of increments 1-10: 5521 m/s

DETONATION VELOCITY DATA

**Material:** Atlas TNT

**Experimenter:** M. J. Urizar    **Date:** February 1, 1955

**Shot no.:** GMX-2-557-A; GMX-8-B-3497

**Diameter:** 0.75 in.    **Average density:** 1.201 g/cm<sup>3</sup>    **Voids:** 27.5%

**Fabrication:** Pressed into tubes    **Confinement:** 0.25-in. wall Dural

**Booster:** 1E15 detonator and TNT

<u>Increment no.</u>	<u>Length (in.)</u>	<u>Density (g/cm<sup>3</sup>)</u>	<u>Velocity (m/s)</u>
1	2.999	1.201	---
2	3.000	1.200	5543
3	3.000	1.201	5578
4	2.999	1.202	5601

**Average velocity of increments 2-4:** 5574 m/s

**DETONATION VELOCITY DATA**

**Material:** Atlas TNT

**Experimenter:** M. J. Urizar      **Date:** March 10, 1955

**Shot no.:** GMX-2-562-A; GMX-8-B-3535

**Diameter:** 0.75 in.      **Average density:** 1.200 g/cm<sup>3</sup>      **Voids:** 27.5%

**Fabrication:** Pressed into tubes      **Confinement:** 0.25-in. wall Dural

**Booster:** 1E15 detonator and Comp B

<b>Increment no.</b>	<b>Length (in.)</b>	<b>Density (g/cm<sup>3</sup>)</b>	<b>Velocity (m/s)</b>
1	3.000	1.201	5602
2	3.000	1.201	5582
3	3.000	1.200	5590
4	3.000	1.201	5596
5	3.000	1.198	5591
6	3.001	1.199	5585
7	3.001	1.199	5588
8	3.001	1.199	5595
9	3.001	1.199	5596
10	3.001	1.199	5595

**Average velocity of increments 1-10:** 5592 m/s

DETONATION VELOCITY DATA

**Material:** Atlas TNT

**Experimenter:** M. J. Urizar      **Date:** March 2, 1955

**Shot no.:** GMX-2-561-A; GMX-8-B-3519

**Diameter:** 0.75 in.      **Average density:** 1.198 g/cm<sup>3</sup>      **Voids:** 27.5%

**Fabrication:** Pressed into tubes      **Confinement:** 0.625-in. wall Lucite

**Booster:** 1E15 detonator and Comp B

<u>Increment no.</u>	<u>Length (in.)</u>	<u>Density (g/cm<sup>3</sup>)</u>	<u>Velocity (m/s)</u>
1	3.001	1.197	---
2	3.000	1.999	5305
3	3.000	1.198	5255
4	3.000	1.199	5299
5	3.001	1.197	5299
6	3.001	1.198	5299
7	3.000	1.198	5292
8	3.001	1.198	5290

**Average velocity of increments 2-8:** 5291 m/s



**DETONATION VELOCITY DATA**

**Material:** Atlas TNT

**Experimenter:** M. J. Urizar      **Date:** June 28, 1955

**Shot no.:** GMX-2-768; GMX-8-B-3657

**Diameter:** 0.7692 in.      **Average density:** 1.200 g/cm<sup>3</sup>      **Voids:** 27.4%

**Fabrication:** Pressed into tubes

**Booster:** 1E15 detonator and Comp B

<u>Increment no.</u>	<u>Length (in.)</u>	<u>Density (g/cm<sup>3</sup>)</u>	<u>Velocity (m/s)</u>
1	3.001	1.198	---
2	3.001	1.199	5557
3	3.001	1.200	5567
4	3.001	1.201	5589
5	3.001	1.200	5563
6	3.001	1.201	5571
7	3.000	1.200	5570
8	3.000	1.201	5564
9	3.000	1.201	5571

**Average velocity of increments 2-9:** 5569 m/s

DETONATION VELOCITY DATA

**Material:** Atlas TNT

**Experimenter:** M. J. Urizar      **Date:** February 25, 1955

**Shot no.:** GMX-2-560-B; GMX-8-B-3517

**Diameter:** 1 in.      **Average density:** 1.199 g/cm<sup>3</sup>      **Voids:** 27.5%

**Fabrication:** Pressed into tubes      **Confinement:** 0.25-in. wall Dural

**Booster:** 1E15 detonator and Comp B

<u>Increment no.</u>	<u>Length (in.)</u>	<u>Density (g/cm<sup>3</sup>)</u>	<u>Velocity (m/s)</u>
1	3.001	1.200	---
2	3.001	1.199	5632
3	3.001	1.200	5598
4	3.002	1.199	5612
5	3.001	1.999	5629
6	3.001	1.198	5603
7	3.000	1.200	5627
8	3.001	1.199	5613

**Average velocity of increments 2-8:** 5616 m/s

**DETONATION VELOCITY DATA**

**Material:** Atlas TNT

**Experimenter:** M. J. Urizar      **Date:** June 22, 1955

**Shot no.:** GMX-2-766; GMX-8-B-3653

**Diameter:** 1.0256 in.      **Average density:** 1.201 g/cm<sup>3</sup>      **Voids:** 27.4%

**Fabrication:** Pressed into tubes      **Confinement:** 0.2-in. wall brass

**Booster:** IE15 detonator and Comp B

<u>Increment no.</u>	<u>Length (in.)</u>	<u>Density (g/cm<sup>3</sup>)</u>	<u>Velocity (m/s)</u>
1	3.001	1.202	---
2	3.001	1.201	5606
3	3.001	1.200	5602
4	3.000	1.200	5600
5	3.001	1.201	5590
6	3.000	1.201	5605
7	3.001	1.201	5597
8	3.001	1.200	5597
9	3.001	1.200	5604

**Average velocity of increments 2-9:** 5600 m/s

DETONATION VELOCITY DATA

Material: Atlas TNT

Experimenter: M. J. Urizar Date: March 15, 1955

Shot no.: GMX-2-672-A; GMX-8-B-3539

Diameter: 1.5 in. Average density: 1.199 g/cm<sup>3</sup> Voids: 27.4%

Fabrication: Pressed into tubes Confinement: 0.25-in. wall Dural

Booster: 1E15 detonator and Comp B

<u>Increment no.</u>	<u>Length (in.)</u>	<u>Density (g/cm<sup>3</sup>)</u>	<u>Velocity (m/s)</u>
1	3.001	1.200	---
2	3.001	1.199	5615
3	3.000	1.200	5636
4	3.000	1.200	5632
5	3.001	1.199	5643
6	3.001	1.199	5650
7	3.001	1.199	5646
8	3.001	1.199	5626

Average velocity of increments 2-8: 5635 m/s

DETONATION VELOCITY DATA

**Material:** Atlas TNT

**Experimenter:** M. J. Urizar      **Date:** June 23, 1955

**Shot no.:** GMX-2-767; GMX-8-B-3654

**Diameter:** 1.5385 in.      **Average density:** 1.200 g/cm<sup>3</sup>      **Voids:** 27.4%

**Fabrication:** Pressed into tubes      **Confinement:** 0.2-in. wall brass

**Booster:** 1E15 detonator and Comp B

<u>Increment no.</u>	<u>Length (in.)</u>	<u>Density (g/cm<sup>3</sup>)</u>	<u>Velocity (m/s)</u>
1	3.000	1.200	5628
2	3.000	1.199	5622
3	3.001	1.200	5625
4	3.001	1.200	5625
5	3.000	1.199	5616
6	3.000	1.199	5622
7	3.000	1.200	5621
8	3.000	1.200	5626
9	3.000	1.200	5623

**Average velocity of increments 1-9:** 5623 m/s

DETONATION VELOCITY DATA

Material: Atlas TNT

Experimenter: M. J. Urizar Date: March 25, 1955

Shot no.: GMX-2-674-B; GMX-8-B-3562

Diameter: 3 in. Average density: 1.200 g/cm<sup>3</sup> Voids: 27.4%

Fabrication: Pressed into tubes Confinement: 1.5-in. wall polystyrene

Booster: 1E15 detonator and Comp B

<u>Increment no.</u>	<u>Length (in.)</u>	<u>Density (g/cm<sup>3</sup>)</u>	<u>Velocity (m/s)</u>
1	5.999	1.201	---
2	6.000	1.200	---
3	6.000	1.199	5644
4	6.000	1.200	5644
5	6.000	1.200	5643
6	6.000	1.200	5637
7	6.000	1.201	5646
8	6.000	1.199	5646
9	6.000	1.200	5640

Average velocity of increments 3-9: 5643 m/s

**DETONATION VELOCITY DATA**

**Material:** Atlas TNT

**Experimenter:** M. J. Urizar      **Date:** March 24, 1955

**Shot no.:** GMX-2-674-A; GMX-8-B-3561

**Diameter:** 3 in.      **Average density:** 1.200 g/cm<sup>3</sup>      **Voids:** 27.4%

**Fabrication:** Pressed into tubes      **Confinement:** 0.5-in. wall brass

**Booster:** 1E15 detonator and Comp B

<u>Increment no.</u>	<u>Length (in.)</u>	<u>Density (g/cm<sup>3</sup>)</u>	<u>Velocity (m/s)</u>
1	6.001	1.200	---
2	6.002	1.200	---
3	6.002	1.200	5658
4	5.998	1.200	5647
5	6.003	1.200	5667
6	6.002	1.200	5660
7	6.002	1.200	5657
8	6.001	1.200	5657
9	6.002	1.200	5654

**Average velocity of increments 3-9:** 5657 m/s

DETONATION VELOCITY DATA

**Material:** Atlas TNT

**Experimenter:** M. J. Urizar      **Date:** March 21, 1955

**Shot no.:** GMX-2-673-A; GMX-8-B-3558

**Diameter:** 3 in.      **Average density:** 1.198 g/cm<sup>3</sup>      **Voids:** 27.4%

**Fabrication:** Pressed into tubes      **Confinement:** 0.5-in. wall Dural

**Booster:** 1E15 detonator, plane wave lens, and Comp B pad

<u>Increment no.</u>	<u>Length (in.)</u>	<u>Density (g/cm<sup>3</sup>)</u>	<u>Velocity (m/s)</u>
1	6.000	1.199	---
2	6.001	1.199	5663
3	6.001	1.199	5681
4	6.001	1.199	5716
5	6.001	1.198	5681
6	6.001	1.198	5681
7	6.001	1.198	5681
8	6.001	1.198	5686
9	6.001	1.198	5673

**Average velocity of increments 2-9:** 5683 m/s



**DETONATION VELOCITY DATA**

**Material:** Atlas TNT

**Experimenter:** M. J. Urizar      **Date:** March 22, 1955

**Shot no.:** GMX-2-673-B; GMX-8-B-3560

**Diameter:** 3 in.      **Average density:** 1.200 g/cm<sup>3</sup>      **Voids:** 27.4%

**Fabrication:** Pressed into tubes      **Confinement:** 0.5-in. wall Dural

**Booster:** 1E15 detonator

<u>Increment no.</u>	<u>Length (in.)</u>	<u>Density (g/cm<sup>3</sup>)</u>	<u>Velocity (m/s)</u>
1	6.001	1.200	---
2	6.001	1.200	---
3	6.002	1.200	5684
4	6.001	1.200	5690
5	6.002	1.200	5690
6	6.001	1.200	5708
7	6.001	1.200	5678
8	6.002	1.200	5688
9	6.001	1.200	5691

**Average velocity of increments 3-9:** 5690 m/s

DETONATION VELOCITY DATA

Material: Atlas TNT

Experimenter: M. J. Urizar Date: July 8, 1955

Shot no.: GMX-2-770; GMX-8-B-3662

Diameter: 3.0769 in. Average density: 1.199 g/cm<sup>3</sup> Voids: 27.4%

Fabrication: Pressed into tubes Confinement: 0.200-in. wall brass

Booster: 1E15 detonator and Comp B

<u>Increment no.</u>	<u>Length (in.)</u>	<u>Density (g/cm<sup>3</sup>)</u>	<u>Velocity (m/s)</u>
1	6.000	1.200	---
2	6.001	1.199	5633
3	6.000	1.200	5677
4	6.001	1.199	5659
5	6.000	1.199	5670
6	6.001	1.199	5663
7	6.000	1.200	5665
8	6.001	1.199	5663
9	6.001	1.199	5667

Average velocity of increments 2-9: 5662 m/s

DETONATION VELOCITY DATA

Material: Atlas TNT

Experimenter: M. J. Urizar Date: June 6, 1955

Shot no.: GMX-2-677-A; GMX-8-B-3640

Diameter: 0.75 in. Average density: 1.299 g/cm<sup>3</sup> Voids: 21.4%

Fabrication: Pressed into tubes Confinement: 0.333-in. wall brass

Booster: 1E15 detonator and Comp B

Increment no.	Length (in.)	Density (g/cm <sup>3</sup> )	Velocity (m/s)
1	3.000	1.297	---
2	3.001	1.298	5903
3	3.001	1.299	5895
4	3.000	1.298	5903
5	3.000	1.299	5888
6	3.000	1.300	5905
7	3.001	1.298	5894
8	3.000	1.299	5893
9	3.000	1.299	5912

Average velocity of increments 2-9: 5899 m/s

DETONATION VELOCITY DATA

**Material:** Atlas TNT

**Experimenter:** M. J. Urizar      **Date:** February 11, 1955

**Shot no.:** GMX-2-558-C and-558-D; GMX-8-D-4966

**Diameter:** 0.75 in.      **Average density:** 1.299 g/cm<sup>3</sup>      **Voids:** 11.4%

**Fabrication:** Pressed into tubes      **Confinement:** 0.25-in. wall Dural

**Booster:** 1E15 detonator and Comp B

<u>Increment no.</u>	<u>Length (in.)</u>	<u>Density (g/cm<sup>3</sup>)</u>	<u>Velocity (m/s)</u>
1	3.001	1.300	---
2	3.001	1.298	5907
3	3.001	1.298	5921
4	3.001	1.298	5921
5	3.001	1.298	5903
6	3.001	1.298	5914
7	3.001	1.299	5929
8	3.001	1.300	5920

**Average velocity of increments 2-8:** 5916 m/s

**DETONATION VELOCITY DATA**

**Material:** Atlas TNT

**Experimenter:** M. J. Urizar      **Date:** February 25, 1955

**Shot no.:** GMX-2-560-C; GMX-8-B-3516

**Diameter:** 1 in.      **Average density:** 1.299 g/cm<sup>3</sup>      **Voids:** 21.4%

**Fabrication:** Pressed into tubes      **Confinement:** 0.25-in. wall Dural

**Booster:** 1E15 detonator and Comp B

<u>Increment no.</u>	<u>Length (in.)</u>	<u>Density (g/cm<sup>3</sup>)</u>	<u>Velocity (m/s)</u>
1	3.001	1.300	---
2	3.001	1.300	5928
3	3.001	1.299	5935
4	3.002	1.299	5934
5	3.001	1.300	5940
6	3.001	1.299	5943
7	3.001	1.299	5952
8	3.001	1.299	5934

**Average velocity of increments 2-8:** 5938 m/s

## DETONATION VELOCITY DATA

**Material:** Atlas TNT

**Experimenter:** M. J. Urizar      **Date:** June 8, 1955

**Shot no.:** GMX-2-678-B; GMX-8-B-3644

**Diameter:** 1.0256 in.      **Average density:** 1.300 g/cm<sup>3</sup>      **Voids:** 21.4%

**Fabrication:** Pressed into tubes      **Confinement:** 0.2-in. wall brass

**Booster:** 1E15 detonator and Comp B

<u>Increment no.</u>	<u>Length (in.)</u>	<u>Density (g/cm<sup>3</sup>)</u>	<u>Velocity (m/s)</u>
1	3.000	1.300	---
2	3.001	1.299	5940
3	3.000	1.301	5916
4	3.001	1.300	5922
5	3.000	1.300	5932
6	3.001	1.299	5927
7	3.001	1.299	5930
8	3.001	1.300	5925
9	3.000	1.300	5933

**Average velocity of increments 2-9:** 5928 m/s

**DETONATION VELOCITY DATA**

**Material:** Atlas TNT

**Experimenter:** M. J. Urizar      **Date:** June 8, 1955

**Shot no.:** GMX-2-678-A; GMX-8-B-3643

**Diameter:** 1.0256 in.      **Average density:** 1.299 g/cm<sup>3</sup>      **Voids:** 21.4%

**Fabrication:** Pressed into tubes      **Confinement:** 0.2-in. brass wall

**Booster:** 1E15 detonator and Comp B

<u>Increment no.</u>	<u>Length (in.)</u>	<u>Density (g/cm<sup>3</sup>)</u>	<u>Velocity (m/s)</u>
1	3.001	1.297	5951
2	3.001	1.297	5891
3	3.001	1.300	5943
4	3.001	1.299	5930
5	3.000	1.301	5925
6	3.000	1.300	5928
7	3.000	1.300	5938
8	3.000	1.300	5910
9	3.001	1.300	5937

**Average velocity of increments 1-9:** 5929 m/s

DETONATION VELOCITY DATA

**Material:** Atlas TNT

**Experimenter:** M. J. Urizar      **Date:** February 8, 1955

**Shot no.:** GMX-2-557-C; GMX-8-D-4962

**Diameter:** 1.5 in.      **Average density:** 1.299 g/cm<sup>3</sup>      **Voids:** 21.4%

**Fabrication:** Pressed into tubes      **Confinement:** 0.25-in. wall Dural

**Booster:** 1E15 detonator and TNT

<u>Increment no.</u>	<u>Length (in.)</u>	<u>Density (g/cm<sup>3</sup>)</u>	<u>Velocity (m/s)</u>
1	3.001	1.299	---
2	3.001	1.299	5940
3	3.001	1.300	5947
4	3.002	1.299	5978

**Average velocity of increments 2-4:** 5955 m/s



DETONATION VELOCITY DATA

**Material:** Atlas TNT

**Experimenter:** M. J. Urizar      **Date:** February 8, 1955

**Shot no.:** GMX-2-557-D; GMX-8-D-4961

**Diameter:** 1.5 in.      **Average density:** 1.299 g/cm<sup>3</sup>      **Voids:** 21.4%

**Fabrication:** Pressed into tubes      **Confinement:** 0.25-in. wall Dural

**Booster:** 1E15 detonator and TNT

<u>Increment no.</u>	<u>Length (in.)</u>	<u>Density (g/cm<sup>3</sup>)</u>	<u>Velocity (m/s)</u>
1	3.002	1.299	---
2	3.002	1.299	5961
3	3.001	1.299	5951
4	3.000	1.300	5975

**Average velocity of increments 2-4:** 5962 m/s

DETONATION VELOCITY DATA

**Material:** Atlas TNT

**Experimenter:** M. J. Urizar      **Date:** June 16, 1955

**Shot no.:** GMX-2-679-B; GMX-8-B-3651

**Diameter:** 1.5385 in.      **Average density:** 1.300 g/cm<sup>3</sup>      **Voids:** 21.4%

**Fabrication:** Pressed into tubes      **Confinement:** 0.2-in. wall brass

**Booster:** 1E15 detonator and Comp B

<u>Increment no.</u>	<u>Length (in.)</u>	<u>Density (g/cm<sup>3</sup>)</u>	<u>Velocity (m/s)</u>
1	3.001	1.298	5931
2	3.000	1.301	5941
3	3.000	1.300	5944
4	3.001	1.300	5965
5	3.001	1.300	5947
6	3.001	1.300	5963
7	3.001	1.300	5957
8	3.001	1.300	5968
9	3.001	1.300	5952

**Average velocity of increments 1-9:** 5952 m/s

**DETONATION VELOCITY DATA**

**Material:** Atlas TNT

**Experimenter:** M. J. Urizar      **Date:** June 16, 1955

**Shot no.:** GMX-2-679-A; GMX-8-B-3652

**Diameter:** 1.5385 in.      **Average density:** 1.300 g/cm<sup>3</sup>      **Voids:** 21.4%

**Fabrication:** Pressed into tubes      **Confinement:** 0.2-in. wall brass

**Booster:** 1E15 detonator and Comp B

<u>Increment no.</u>	<u>Length (in.)</u>	<u>Density (g/cm<sup>3</sup>)</u>	<u>Velocity (m/s)</u>
1	3.000	1.302	---
2	3.001	1.299	5955
3	3.000	1.301	5957
4	3.000	1.301	5962
5	3.000	1.301	5946
6	3.001	1.300	5960
7	3.001	1.300	5961
8	3.001	1.300	5947
9	3.001	1.300	5948

**Average velocity of increments 2-9:** 5955 m/s

DETONATION VELOCITY DATA

**Material:** Atlas TNT

**Experimenter:** M. J. Urizar      **Date:** April 11, 1955

**Shot no.:** GMX-2-675; GMX-8-B-3613

**Diameter:** 3 in.      **Average density:** 1.300 g/cm<sup>3</sup>      **Voids:** 21.4%

**Fabrication:** Pressed into tubes      **Confinement:** 0.5-in. wall Dural

**Booster:** 1E15 detonator and Comp B

<u>Increment no.</u>	<u>Length (in.)</u>	<u>Density (g/cm<sup>3</sup>)</u>	<u>Velocity (m/s)</u>
1	6.001	1.300	---
2	6.001	1.300	---
3	6.002	1.300	6006
4	6.000	1.300	6005
5	6.002	1.300	6020
6	6.001	1.300	6000
7	6.000	1.300	6003
8	6.000	1.300	5994
9	6.001	1.300	5995

**Average velocity of increments 3-9:** 6003 m/s

DETONATION VELOCITY DATA

**Material:** Atlas TNT

**Experimenter:** M. J. Urizar      **Date:** September 27, 1955

**Shot no.:** GMX-2-820; GMX-8-B-3772

**Diameter:** 3.077 in.      **Average density:** 1.299 g/cm<sup>3</sup>      **Voids:** 21.4%

**Fabrication:** Pressed into tubes

**Booster:** 1E15 detonator and Comp B

<u>Increment no.</u>	<u>Length (in.)</u>	<u>Density (g/cm<sup>3</sup>)</u>	<u>Velocity (m/s)</u>
1	6.0000	1.299	5926
2	6.0002	1.299	5952
3	6.0002	1.299	5975
4	6.0004	1.299	5989
5	6.0004	1.299	5977
6	6.0003	1.299	5989
7	6.0005	1.299	5984
8	6.0003	1.299	5987
9	6.0000	1.299	5975

**Average velocity of increments 1-9:** 5973 m/s

DETONATION VELOCITY DATA

Material: Atlas TNT

Experimenter: M. J. Urizar Date: September 27, 1955

Shot no.: GMX-2-784; GMX-8-B-3773

Diameter: 3.077 in. Average density: 1.299 g/cm<sup>3</sup> Voids: 21.4%

Fabrication: Pressed into tubes

Booster: 1E15 detonator and Comp B

<u>Increment no.</u>	<u>Length (in.)</u>	<u>Density (g/cm<sup>3</sup>)</u>	<u>Velocity (m/s)</u>
1	6.0002	1.299	5943
2	6.0005	1.299	5956
3	6.0003	1.300	5986
4	6.0002	1.299	5996
5	6.9990	1.299	5985
6	6.0005	1.300	5979
7	6.0003	1.299	5987
8	6.0002	1.300	5989
9	6.000	1.299	5981

Average velocity of increments 1-9: 5978 m/s

DETONATION VELOCITY DATA

**Material:** Atlas TNT

**Experimenter:** M. J. Urizar      **Date:** July 8, 1955

**Shot no.:** GMX-2-771; GMX-8-B-3663

**Diameter:** 3.0769 in.      **Average density:** 1.299 g/cm<sup>3</sup>      **Voids:** 21.4%

**Fabrication:** Pressed into tubes      **Confinement:** 0.2-in. wall brass

**Booster:** 1E15 detonator and Comp B

<u>Increment no.</u>	<u>Length (in.)</u>	<u>Density (g/cm<sup>3</sup>)</u>	<u>Velocity (m/s)</u>
1	6.000	1.300	5941
2	6.000	1.299	5956
3	6.000	1.299	5981
4	6.000	1.300	5990
5	6.000	1.299	5982
6	6.001	1.299	5988
7	6.000	1.300	5992
8	6.001	1.299	5992
9	6.001	1.299	5981

**Average velocity of increments 1-9:** 5978 m/s

DETONATION VELOCITY DATA

**Material:** Atlas TNT

**Experimenter:** M. J. Urizar      **Date:** November 9, 1955

**Shot no.:** GMX-2-821-F; GMX-8-B-3824

**Diameter:** 1.025 in.      **Average density:** 1.426 g/cm<sup>3</sup>      **Voids:** 12.6%

**Fabrication:** Machined from 6-in. pieces      **Unconfined**

**Booster:** 1E15 detonator and Comp B

<u>Increment no.</u>	<u>Length (in.)</u>	<u>Density (g/cm<sup>3</sup>)</u>	<u>Velocity (m/s)</u>
1	3.000	1.426	6387
2	3.000	1.427	6366
3	3.000	1.431	6394
4	3.000	1.429	6393
5	3.000	1.429	6388
6	3.000	1.428	6390
7	3.000	1.429	6392
8	3.000	1.429	6394
9	3.000	1.430	6395

**Average velocity of increments 1-9:** 6389 m/s



DETONATION VELOCITY DATA

**Material:** Atlas TNT

**Experimenter:** M. J. Urizar      **Date:** November 9, 1955

**Shot no.:** GMX-2-821-H; GMX-8-3822

**Diameter:** 0.7683 in.      **Average density:** 1.438 g/cm<sup>3</sup>      **Voids:** 12.6%

**Fabrication:** Machined from 6-in. pieces      **Unconfined**

**Booster:** 1E15 detonator and Comp B

<u>Increment no.</u>	<u>Length (in.)</u>	<u>Density (g/cm<sup>3</sup>)</u>	<u>Velocity (m/s)</u>
1	3.000	1.436	6393
2	3.000	1.438	6380
3	3.000	1.437	6356
4	3.000	1.438	6361
5	3.000	1.438	6372
6	3.000	1.438	6507
7	3.000	1.438	6224
8	3.000	1.438	6368
9	3.000	1.438	6374

**Average velocity of increments 1-9:** 6371 m/s

DETONATION VELOCITY DATA

Material: Atlas TNT

Experimenter: M. J. Urizar Date: November 9, 1955

Shot no.: GMX-2-821-G; GMX-8-B-3823

Diameter: 0.768 in. Average density: 1.443 g/cm<sup>3</sup> Voids: 12.6%

Fabrication: Fitted into brass tubes Confinement: 0.2-in. wall brass

Booster: 1E15 detonator and Comp B

<u>Increment no.</u>	<u>Length (in.)</u>	<u>Density (g/cm<sup>3</sup>)</u>	<u>Velocity (m/s)</u>
1	3.000	1.442	6409
2	3.000	1.444	6386
3	3.000	1.444	6398
4	3.000	1.444	6400
5	3.000	1.442	6378
6	3.000	1.449	6427
7	3.000	1.442	6391
8	3.000	1.441	6368
9	3.000	1.441	6369

Average velocity of increments: 6392 m/s

DETONATION VELOCITY DATA

**Material:** Atlas TNT

**Experimenter:** M. J. Urizar      **Date:** November 9, 1955

**Shot no.:** GMX-2-821-E; GMX-8-B-3831

**Diameter:** 1.025 in.      **Average density:** 1.437 g/cm<sup>3</sup>      **Voids:** 12.6%

**Fabrication:** Fitted into brass tubes      **Confinement:** 0.2-in. wall brass

**Booster:** 1E15 detonator and Comp B

<u>Increment no.</u>	<u>Length (in.)</u>	<u>Density (g/cm<sup>3</sup>)</u>	<u>Velocity (m/s)</u>
1	3.000	1.431	6396
2	3.000	1.433	6378
3	3.000	1.433	6367
4	3.000	1.437	6383
5	3.000	1.440	6418
6	3.000	1.443	6417
7	3.000	1.439	6414
8	3.000	1.440	6401
9	3.000	1.439	6418

**Average velocity of increments 1-9:** 6399 m/s

DETONATION VELOCITY DATA

Material: Atlas TNT

Experimenter: M. J. Urizar Date: November 8, 1955

Shot no.: GMX-2-821-B; GMX-8-B-3832

Diameter: 1.538 in. Average density: 1.443 g/cm<sup>3</sup> Voids: 12.6%

Fabrication: Machined from 6-in. pressings Unconfined

Booster: 1E15 detonator and Comp B

<u>Increment no.</u>	<u>Length (in.)</u>	<u>Density (g/cm<sup>3</sup>)</u>	<u>Velocity (m/s)</u>
1	3.001	1.439	6422
2	3.002	1.441	6418
3	3.001	1.440	6422
4	3.001	1.440	6432
5	3.001	1.442	6433
6	3.001	1.442	6433
7	3.001	1.447	6449
8	3.001	1.447	6449
9	3.001	1.449	6455

Average velocity of increments 1-9: 6435 m/s

DETONATION VELOCITY DATA

**Material:** Atlas TNT

**Experimenter:** M. J. Urizar      **Date:** November 8, 1955

**Shot no.:** GMX-2-821-A; GMX-8-B-3821

**Diameter:** 1.538 in.      **Average density:** 1.444 g/cm<sup>3</sup>      **Voids:** 12.6%

**Fabrication:** Machined to fit tubes      **Confinement:** 0.2-in. wall brass

**Booster:** 1E15 detonator and Comp B

<u>Increment no.</u>	<u>Length (in.)</u>	<u>Density (g/cm<sup>3</sup>)</u>	<u>Velocity (m/s)</u>
1	3.000	1.443	---
2	3.000	1.443	---
3	3.000	1.444	6433
4	3.000	1.445	6437
5	3.000	1.444	6435
6	3.000	1.446	6445
7	3.000	1.443	6431
8	3.000	1.446	6457

**Average velocity of increments 3-8:** 6440 m/s

DETONATION VELOCITY DATA

**Material:** Atlas TNT

**Experimenter:** M. J. Urizar      **Date:** November 9, 1955

**Shot no.:** GMX-2-821-D; GMX-8-B-3820

**Diameter:** 3.080 in.      **Average density:** 1.437 g/cm<sup>3</sup>      **Voids:** 12.6%

**Fabrication:** Machined from 6-in. pieces      **Unconfined**

**Booster:** IE15 detonator and Comp B

<u>Increment no.</u>	<u>Length (in.)</u>	<u>Density (g/cm<sup>3</sup>)</u>	<u>Velocity (m/s)</u>
1	5.000	1.435	---
2	5.000	1.437	6417
3	5.000	1.436	6416
4	5.000	1.436	6435
5	5.000	1.436	6426
6	5.000	1.442	6460
7	5.000	1.439	6446
8	5.000	1.435	6432
9	5.000	1.438	6444

**Average velocity of increments 2-9:** 6435 m/s

DETONATION VELOCITY DATA

**Material:** Atlas TNT

**Experimenter:** M. J. Urizar      **Date:** November 9, 1955

**Shot no.:** GMX-2-821-C; GMX-8-B-3833

**Diameter:** 3.080 in.      **Average density:** 1.443 g/cm<sup>3</sup>      **Voids:** 12.6%

**Fabrication:** Machined to fit tubes      **Confinement:** 0.2-in. wall brass

**Booster:** 1E15 detonator and Comp B

<u>Increment no.</u>	<u>Length (in.)</u>	<u>Density (g/cm<sup>3</sup>)</u>	<u>Velocity (m/s)</u>
1	6.000	1.436	6402
2	6.000	1.442	6441
3	6.001	1.442	6449
4	6.001	1.443	6458
5	6.000	1.442	6457
6	6.001	1.444	6471
7	6.000	1.443	6454
8	6.001	1.448	6481
9	6.000	1.444	6467

**Average velocity of increments 1-9:** 6453 m/s

DETONATION VELOCITY DATA

**Material:** Atlas TNT

**Experimenter:** M. J. Urizar      **Date:** August 29, 1955

**Shot no.:** GMX-2-774; GMX-8-B-3743

**Diameter:** 0.7683 in.      **Average density:** 1.451 g/cm<sup>3</sup>      **Voids:** 12.3%

**Fabrication:** Pressed into tubes      **Confinement:** 0.2-in. wall brass

**Booster:** 1E15 detonator and Comp B

<u>Increment no.</u>	<u>Length (in.)</u>	<u>Density (g/cm<sup>3</sup>)</u>	<u>Velocity (m/s)</u>
1	3.000	1.452	6428
2	3.000	1.452	6427
3	3.000	1.451	6429
4	3.000	1.449	6404
5	3.000	1.450	6404
6	3.000	1.451	6428
7	3.000	1.450	6422
8	3.000	1.451	6410
9	3.000	1.450	6418

**Average velocity of increments 1-9:** 6419 m/s



DETONATION VELOCITY DATA

**Material:** Atlas TNT

**Experimenter:** M. J. Urizar      **Date:** August 26, 1955

**Shot no.:** GMX-2-773; GMX-8-B-3742

**Diameter:** 1.025 in.      **Average density:** 1.450 g/cm<sup>3</sup>      **Voids:** 12.3%

**Fabrication:** Pressed into tubes      **Confinement:** 0.2-in. wall brass

**Booster:** 1E15 detonator and Comp B

<u>Increment no.</u>	<u>Length (in.)</u>	<u>Density (g/cm<sup>3</sup>)</u>	<u>Velocity (m/s)</u>
1	3.000	1.447	---
2	3.000	1.449	6423
3	3.000	1.451	6435
4	3.000	1.449	6430
5	2.9995	1.449	6427
6	3.000	1.450	6429
7	3.004	1.450	6425
8	3.000	1.451	6429
9	3.000	1.451	6431

**Average velocity of increments 2-9:** 6429 m/s

DETONATION VELOCITY DATA

Material: Atlas TNT

Experimenter: M. J. Urizar Date: July 12, 1955

Shot no.: GMX-2-772; GMX-8-B-3666

Diameter: 1.5385 in. Average density: 1.449 g/cm<sup>3</sup> Voids: 12.3%

Fabrication: Pressed into tubes Confinement: 0.2-in. wall brass

Booster: 1E15 detonator and Comp B

<u>Increment no.</u>	<u>Length (in.)</u>	<u>Density (g/cm<sup>3</sup>)</u>	<u>Velocity (m/s)</u>
1	3.001	1.449	---
2	3.001	1.448	6437
3	3.000	1.449	6449
4	3.001	1.449	6449
5	3.000	1.449	6448
6	3.000	1.449	6464
7	3.000	1.449	6445
8	3.000	1.449	6469
9	3.000	1.448	6433

Average velocity of increments 2-9: 6449 m/s

DETONATION VELOCITY DATA

Material: Atlas TNT

Experimenter: C. L. Mader Date: September 12, 1955

Shot no.: GMX-2-670-G; GMX-8-B-3762

Diameter: 1.625 in. Average density: 1.454 g/cm<sup>3</sup>

Fabrication: Pressed pellets

Booster: 1E15 detonator and Comp B

<u>Increment no.</u>	<u>Length (in.)</u>	<u>Density (g/cm<sup>3</sup>)</u>	<u>Velocity (m/s)</u>
1	0.973	1.447	---
2	0.9713	1.450	---
3	0.9695	1.455	6492
4	0.969	1.455	6475
5	0.9691	1.456	6500
6	0.969	1.455	6494
7	0.969	1.455	6515
8	0.969	1.456	6486
9	0.9685	1.457	6522
10	0.9685	1.456	6484
11	0.9685	1.456	6508

Average velocity of increments 3-10: 6497 m/s

DETONATION VELOCITY DATA

Material: Atlas TNT

Experimenter: M. J. Urizar Date: December 8, 1954

Shot no.: GMX-2-478-B; GMX-8-B-3467

Diameter: 0.75 in. Average density: 1.4570 g/cm<sup>3</sup> Voids: 12%

Fabrication: 6-in. mold Unconfined

Booster: 1E15 detonator

<u>Increment no.</u>	<u>Length (in.)</u>	<u>Density (g/cm<sup>3</sup>)</u>	<u>Velocity (m/s)</u>
1	2.0007	1.462	---
2	2.0007	1.4555	6446
3	2.0005	1.4555	6450
4	2.0003	1.4550	6439

Average velocity of increments 2-4: 6445 m/s

DETONATION VELOCITY DATA

**Material:** Atlas TNT

**Experimenter:** M. J. Urizar      **Date:** December 8, 1954

**Shot no.:** GMX-2-478-D; GMX-8-B-3466

**Diameter:** 1.000 in.      **Average density:** 1.4616 g/cm<sup>3</sup>      **Voids:** 12%

**Fabrication:** 6-in. mold      **Unconfined**

**Booster:** 1E15 detonator

<u>Increment no.</u>	<u>Length (in.)</u>	<u>Density (g/cm<sup>3</sup>)</u>	<u>Velocity (m/s)</u>
1	2.0004	1.466	---
2	2.0007	1.4605	6484
3	2.0007	1.4605	6497
4	2.0000	1.4595	6492

**Average velocity of increments 2-4:** 6491 m/s

DETONATION VELOCITY DATA

**Material:** Atlas TNT

**Experimenter:** M. J. Urizar      **Date:** December 8, 1954

**Shot no.:** GMX-2-478-H; GMX-8-B-3469

**Diameter:** 3.000 in.      **Average density:** 1.4603 g/cm<sup>3</sup>      **Voids:** 12%

**Fabrication:** 6-in. mold      **Unconfined**

**Booster:** 1E15 detonator

<u>Increment no.</u>	<u>Length (in.)</u>	<u>Density (g/cm<sup>3</sup>)</u>	<u>Velocity (m/s)</u>
1	2.0000	1.463	---
2	2.0009	1.460	6452
3	2.0013	1.4595	6465
4	2.0008	1.4585	6491

**Average velocity of increments 2-4:** 6469 m/s

DETONATION VELOCITY DATA

**Material:** Atlas TNT

**Experimenter:** M. J. Urizar      **Date:** August 31, 1955

**Shot no.:** GMX-2-775; GMX-8-B-3755

**Diameter:** 3.077 in.      **Average density:** 1.455 g/cm<sup>3</sup>      **Voids:** 12.3%

**Fabrication:** Pressed into tubes      **Confinement:** 0.2 in. wall brass

**Booster:** 1E13 detonator and Comp B

<u>Increment no.</u>	<u>Length (in.)</u>	<u>Density (g/cm<sup>3</sup>)</u>	<u>Velocity (m/s)</u>
1	6.000	1.449	6459
2	6.0004	1.448	6463
3	6.000	1.500	6474
4	5.999	1.449	6479
5	---	--	6479
6	6.0005	1.448	6479
7	6.0008	1.449	6476
8	6.0008	1.449	6472
9	6.000	1.449	6476

**Average velocity of increments 1-9:** 6473 m/s

DETONATION VELOCITY DATA

**Material:** Atlas TNT

**Experimenter:** M. J. Urizar    **Date:** December 8, 1954

**Shot no.:** GMX-2-478-C; GMX-8-B-3464

**Diameter:** 1.000 in.    **Average density:** 1.4704 g/cm<sup>3</sup>    **Voids:** 12%

**Fabrication:** 6-in. mold    **Unconfined**

**Booster:** 1E15 detonator

<u>Increment no.</u>	<u>Length (in.)</u>	<u>Density (g/cm<sup>3</sup>)</u>	<u>Velocity (m/s)</u>
1	2.0005	1.475	---
2	2.0004	1.469	6504
3	2.0002	1.469	6532
4	2.0009	1.4685	6520

**Average velocity of increments 2-4:** 6519 m/s



**DETONATION VELOCITY DATA**

**Material:** Atlas TNT

**Experimenter:** M. J. Urizar      **Date:** December 8, 1954

**Shot no.:** GMX-2-478-F; GMX-8-B-3463

**Diameter:** 1.500 in.      **Average density:** 1.4691 g/cm<sup>3</sup>      **Voids:** 12%

**Fabrication:** 6-in. mold      **Unconfined**

**Booster:** 1E15 detonator

<u>Increment no.</u>	<u>Length (in.)</u>	<u>Density (g/cm<sup>3</sup>)</u>	<u>Velocity (m/s)</u>
1	2.0019	1.470	---
2	2.0005	1.4695	6486
3	2.0000	1.4690	6501
4	2.0012	1.4680	6514

**Average velocity of increments 2-4:** 6500 m/s

DETONATION VELOCITY DATA

Material: Atlas TNT

Experimenter: M. J. Urizar      Date: December 8, 1954

Shot no.: GMX-2-478-G; GMX-8-B-3470

Diameter: 3.000 in.      Average density: 1.4671 g/cm<sup>3</sup>      Voids: 12%

Fabrication: 6-in. mold      Unconfined

Booster: 1E15 detonator

<u>Increment no.</u>	<u>Length (in.)</u>	<u>Density (g/cm<sup>3</sup>)</u>	<u>Velocity (m/s)</u>
1	2.0015	1.471	---
2	2.0010	1.4660	6473
3	2.0007	1.4665	6508
4	2.0020	1.4650	6512

Average velocity of increments 2-4: 6498 m/s

**DETONATION VELOCITY DATA**

**Material:** Atlas TNT

**Experimenter:** M. J. Urizar      **Date:** December 8, 1954

**Shot no.:** GMX-2-478-E; GMX-8-B-3465

**Diameter:** 1.500 in.      **Average density:** 1.476 g/cm<sup>3</sup>      **Voids:** 12%

**Fabrication:** 6-in. mold      **Unconfined**

**Booster:** 1E15 detonator

<u>Increment no.</u>	<u>Length (in.)</u>	<u>Density (g/cm<sup>3</sup>)</u>	<u>Velocity (m/s)</u>
1	2.0018	1.471	---
2	2.0002	1.4765	6506
3	2.0002	1.4755	6537
4	1.9975	1.4750	6548

**Average velocity of increments 2-4:** 6530 m/s

DETONATION VELOCITY DATA

Material: Atlas TNT

Experimenter: M. J. Urizar      Date: December 13, 1954

Shot no.: GMX-2-464-B; GMX-8-D-4908

Diameter: 0.750 in.      Average density: 1.5333 g/cm<sup>3</sup>      Voids: 7%

Fabrication: 6-in. mold      Unconfined

Booster: 1E15 detonator

<u>Increment no.</u>	<u>Length (in.)</u>	<u>Density (g/cm<sup>3</sup>)</u>	<u>Velocity (m/s)</u>
1	2.0018	1.357	---
2	2.0015	1.5305	6748
3	2.0021	1.5325	6717
4	2.0014	1.533	6728

Average velocity of increments 2-4: 6731 m/s

DETONATION VELOCITY DATA

**Material:** Atlas TNT

**Experimenter:** M. J. Urizar      **Date:** December 19, 1955

**Shot no.:** GMX-2-826-A; GMX-8-B-3843

**Diameter:** 0.768 in.      **Average density:** 1.530 g/cm<sup>3</sup>      **Voids:** 7%

**Fabrication:** Machined to fit tubes      **Confinement:** 0.2-in. wall brass

**Booster:** 1E15 detonator and Comp B

<u>Increment no.</u>	<u>Length (in.)</u>	<u>Density (g/cm<sup>3</sup>)</u>	<u>Velocity (m/s)</u>
1	3.0005	1.523	6689
2	3.0005	1.534	6710
3	3.001	1.532	6722
4	3.000	1.532	6717
5	3.000	1.528	6724
6	3.0005	1.524	6718
7	3.000	1.536	6739
8	3.000	1.531	6723
9	3.000	1.532	6726

**Average velocity of increments 1-9:** 6719 m/s

## DETONATION VELOCITY DATA

**Material:** Atlas TNT

**Experimenter:** M. J. Urizar      **Date:** December 19, 1955

**Shot no.:** GMX-2-826-B; GMX-8-B-3844

**Diameter:** 1.025 in.      **Average density:** 1.532 g/cm<sup>3</sup>      **Voids:** 7%

**Fabrication:** Fitted to brass tubes      **Confinement:** 0.2-in. wall brass

**Booster:** 1E15 detonator and Comp B

<u>Increment no.</u>	<u>Length (in.)</u>	<u>Density (g/cm<sup>3</sup>)</u>	<u>Velocity (m/s)</u>
1	3.001	1.533	6697
2	3.0005	1.531	6704
3	3.000	1.532	6714
4	3.0005	1.535	6745
5	3.0005	1.538	6745
6	3.000	1.526	6692
7	3.000	1.536	6740
8	3.000	1.531	6700
9	3.000	1.528	6698

**Average velocity of increments 1-9:** 6715 m/s

DETONATION VELOCITY DATA

**Material:** Atlas TNT

**Experimenter:** M. J. Urizar      **Date:** December 19, 1955

**Shot no.:** GMX-2-826-C; GMX-8-B-3842

**Diameter:** 1.538 in.      **Average density:** 1.533 g/cm<sup>3</sup>      **Voids:** 7%

**Fabrication:** Fitted into brass tubes      **Confinement:** 0.2-in. wall brass

**Booster:** 1E15 detonator and Comp B

<u>Increment no.</u>	<u>Length (in.)</u>	<u>Density (g/cm<sup>3</sup>)</u>	<u>Velocity (m/s)</u>
1	3.0015	1.530	6711
2	3.0005	1.525	6683
3	3.0005	1.525	6712
4	3.001	1.537	6748
5	3.0005	1.533	6724
6	3.001	1.534	6736
7	3.0015	1.539	6751
8	3.0005	1.539	6756
9	3.0005	1.536	6767

**Average velocity of increments 1-9:** 6732 m/s

DETONATION VELOCITY DATA

Material: Atlas TNT

Experimenter: M. J. Urizar Date: December 10, 1954

Shot no.: GMX-2-464-H; GMX-8-D-4910

Diameter: 3.000 in. Average density: 1.534 g/cm<sup>3</sup> Voids: 7%

Fabrication: 6-in. mold Unconfined

Booster: 1E15 detonator

<u>Increment no.</u>	<u>Length (in.)</u>	<u>Density (g/cm<sup>3</sup>)</u>	<u>Velocity (m/s)</u>
1	2.0016	1.529	---
2	2.0020	1.5355	6760
3	2.0012	1.5365	6741
4	2.0016	1.5365	6749

Average velocity of increments 2-4: 6750 m/s



DETONATION VELOCITY DATA

**Material:** Atlas TNT

**Experimenter:** M. J. Urizar      **Date:** December 19, 1955

**Shot no.:** GMX-2-826-D; GMX-8-B-3845

**Diameter:** 3.076 in.      **Average density:** 1.534 g/cm<sup>3</sup>      **Voids:** 7%

**Fabrication:** Fitted into brass tubes

**Booster:** 1E15 detonator and Comp B

<u>Increment no.</u>	<u>Length (in.)</u>	<u>Density (g/cm<sup>3</sup>)</u>	<u>Velocity (m/s)</u>
1	6.001	1.536	6735
2	6.001	1.536	6736
3	6.000	1.536	6751
4	5.999	1.536	6751
5	5.999	1.534	6755
6	6.000	1.531	6732
7	6.000	1.531	6755
8	5.999	1.533	6735
9	6.001	1.536	6750

**Average velocity of increments 1-9:** 6744 m/s

DETONATION VELOCITY DATA

Material: Atlas TNT

Experimenter: M. J. Urizar Date: December 13, 1954

Shot no.: GMX-2-464-A; GMX-8-D-4907

Diameter: 0.750 in. Average density: 1.5403 g/cm<sup>3</sup> Voids: 7%

Fabrication: 6-in. mold Unconfined

Booster: 1E15 detonator

<u>Increment no.</u>	<u>Length (in.)</u>	<u>Density (g/cm<sup>3</sup>)</u>	<u>Velocity (m/s)</u>
1	2.0017	1.547	---
2	2.0000	1.538	6763
3	2.0014	1.5385	6769
4	2.0018	1.5375	6768

Average velocity of increments 2-4: 6767 m/s

**DETONATION VELOCITY DATA**

**Material:** Atlas TNT

**Experimenter:** M. J. Urizar      **Date:** December 13, 1954

**Shot no.:** GMX-2-464-D; GMX-8-D-4906

**Diameter:** 1.000 in.      **Average density:** 1.5371 g/cm<sup>3</sup>      **Voids:** 7%

**Fabrication:** 6-in. mold      **Unconfined**

**Booster:** 1E15 detonator

<u>Increment no.</u>	<u>Length (in.)</u>	<u>Density (g/cm<sup>3</sup>)</u>	<u>Velocity (m/s)</u>
1	2.0009	1.539	---
2	2.0009	1.5365	6750
3	2.0012	1.5365	6767
4	2.0010	1.5365	6763

**Average velocity of increments 2-4:** 6760 m/s

DETONATION VELOCITY DATA

**Material:** Atlas TNT

**Experimenter:** M. J. Urizar      **Date:** December 13, 1954

**Shot no.:** GMX-2-464-C; GMX-8-D-4911

**Diameter:** 1.000 in.      **Average density:** 1.5438 g/cm<sup>3</sup>      **Voids:** 7%

**Fabrication:** 6-in. mold      **Unconfined**

**Booster:** 1E15 detonator

<u>Increment no.</u>	<u>Length (in.)</u>	<u>Density (g/cm<sup>3</sup>)</u>	<u>Velocity (m/s)</u>
1	2.0007	1.547	---
2	2.0008	1.543	6772
3	2.0009	1.5425	6776
4	2.0004	1.5425	6774

**Average velocity of increments 2-4:** 6774 m/s

**DETONATION VELOCITY DATA**

**Material:** Atlas TNT

**Experimenter:** M. J. Urizar      **Date:** December 13, 1954

**Shot no.:** GMX-2-464-F; GMX-8-D-4905

**Diameter:** 1.500 in.      **Average density:** 1.5355 g/cm<sup>3</sup>      **Voids:** 7%

**Fabrication:** 6-in. mold      **Unconfined**

**Booster:** 1E15 detonator

<u>Increment no.</u>	<u>Length (in.)</u>	<u>Density (g/cm<sup>3</sup>)</u>	<u>Velocity (m/s)</u>
1	1.9992	1.5360	---
2	2.0012	1.5365	6740
3	2.0010	1.5350	6735
4	1.9996	1.5345	6748

**Average velocity of increments 2-4:** 6741 m/s

DETONATION VELOCITY DATA

**Material:** Atlas TNT

**Experimenter:** M. J. Urizar      **Date:** December 13, 1954

**Shot no.:** GMX-2-464-E; GMX-8-D-4904

**Diameter:** 1.500 in.      **Average density:** 1.543 g/cm<sup>3</sup>      **Voids:** 7%

**Fabrication:** 6-in. mold      **Unconfined**

**Booster:** 1E15 detonator

<u>Increment no.</u>	<u>Length (in.)</u>	<u>Density (g/cm<sup>3</sup>)</u>	<u>Velocity (m/s)</u>
1	2.0018	1.544	---
2	2.0020	1.543	6771
3	2.0020	1.543	6768
4	2.0007	1.543	6768

**Average velocity of increments 2-4:** 6769 m/s

DETONATION VELOCITY DATA

**Material:** Atlas TNT

**Experimenter:** M. J. Urizar      **Date:** December 10, 1954

**Shot no.:** GMX-2-464-G; GMX-8-D-4909

**Diameter:** 3.000 in.      **Average density:** 1.542 g/cm<sup>3</sup>      **Voids:** 7%

**Fabrication:** 6-in. mold      **Unconfined**

**Booster:** 1E15 detonator

<u>Increment no.</u>	<u>Length (in.)</u>	<u>Density (g/cm<sup>3</sup>)</u>	<u>Velocity (m/s)</u>
1	2.0016	1.540	--
2	2.0012	1.5435	6757
3	2.0016	1.5425	6778
4	2.0016	1.5435	6768

**Average velocity of increments 2-4:** 6768 m/s

DETONATION VELOCITY DATA

**Material:** Atlas TNT

**Experimenter:** C. L. Mader      **Date:** September 8, 1955

**Shot no.:** GMX-2-670-671-E; GMX-8-B-3765

**Diameter:** 1.625 in.      **Average density:** 1.548 g/cm<sup>3</sup>

**Fabrication:** Pressed pellets

**Booster:** 1E15 detonator and Comp B

<u>Increment no.</u>	<u>Length (in.)</u>	<u>Density (g/cm<sup>3</sup>)</u>	<u>Velocity (m/s)</u>
1	0.9705	1.625	---
2	0.969	1.626	6908
3	0.9712	1.625	6893
4	0.9705	1.625	7069
5	0.9695	1.458	6410
6	0.9697	1.458	6504
7	0.9699	1.458	6510
8	0.9701	1.626	6898
9	0.9707	1.625	6906
10	0.9698	1.626	6917
11	0.9694	1.459	6556
12	0.9692	1.459	6554
13	0.9695	1.458	6487

**Average velocity of increments 2-13:** 6718 m/s



DETONATION VELOCITY DATA

**Material:** Atlas TNT

**Experimenter:** C. L. Mader      **Date:** September 8, 1955

**Shot no.:** GMX-2-670-671-D; GMX-8-B-3766

**Diameter:** 1.625 in.      **Average density:** 1.558 g/cm<sup>3</sup>

**Fabrication:** Pressed pellets

**Booster:** 1E15 detonator and Comp B

<u>Increment no.</u>	<u>Length (in.)</u>	<u>Density (g/cm<sup>3</sup>)</u>	<u>Velocity (m/s)</u>
1	0.9707	1.624	---
2	0.9698	1.626	6909
3	0.9695	1.626	6932
4	0.970	1.626	6866
5	0.9698	1.626	6921
6	0.9705	1.456	6678
7	0.9705	1.456	6387
8	0.9702	1.626	6931
9	0.970	1.626	6884
10	0.9705	1.457	6545
11	0.970	1.458	6521
12	0.970	1.626	7158
13	0.9702	1.626	6898
14	0.970	1.457	6369
15	0.9699	1.457	6522

**Average velocity of increments 2-15:** 6752 m/s

DETONATION VELOCITY DATA

**Material:** Atlas TNT

**Experimenter:** M. J. Urizar      **Date:** December 13, 1954

**Shot no.:** GMX-2-465-H; GMX-8-D-4916

**Diameter:** 3.000 in.      **Average density:** 1.5643 g/cm<sup>3</sup>      **Voids:** 5%

**Fabrication:** 6-in. mold      **Unconfined**

**Booster:** 1E15 detonator

<u>Increment no.</u>	<u>Length (in.)</u>	<u>Density (g/cm<sup>3</sup>)</u>	<u>Velocity (m/s)</u>
1	2.0012	1.558	---
2	2.0012	1.566	6825
3	2.0012	1.5665	6825
4	2.0018	1.5665	6830

**Average velocity of increments 2-4:** 6827 m/s

DETONATION VELOCITY DATA

**Material:** Atlas TNT

**Experimenter:** M. J. Urizar      **Date:** December 14, 1954

**Shot no.:** GMX-2-465-B; GMX-8-B-3480

**Diameter:** 0.750 in.      **Average density:** 1.5673 g/cm<sup>3</sup>      **Voids:** 5%

**Fabrication:** 6-in. mold      **Unconfined**

**Booster:** 1E15 detonator

<u>Increment no.</u>	<u>Length (in.)</u>	<u>Density (g/cm<sup>3</sup>)</u>	<u>Velocity (m/s)</u>
1	2.0003	1.563	---
2	2.0005	1.5685	6842
3	2.0013	1.5685	6851
4	2.0008	1.5690	6848

**Average velocity of increments 2-4:** 6847 m/s

DETONATION VELOCITY DATA

**Material:** Atlas TNT

**Experimenter:** M. J. Urizar      **Date:** December 14, 1954

**Shot no.:** GMX-2-465-A; GMX-8-B-3479

**Diameter:** 0.750 in.      **Average density:** 1.573 g/cm<sup>3</sup>      **Voids:** 5%

**Fabrication:** 6-in. mold      **Unconfined**

**Booster:** 1E15 detonator

<u>Increment no.</u>	<u>Length (in.)</u>	<u>Density (g/cm<sup>3</sup>)</u>	<u>Velocity (m/s)</u>
1	2.0006	1.575	---
2	2.0008	1.572	6856
3	2.0007	1.5715	6860
4	2.0012	1.573	6863

**Average velocity of increments 2-4:** 6860 m/s

**DETONATION VELOCITY DATA**

**Material:** Atlas TNT

**Experimenter:** M. J. Urizar      **Date:** December 14, 1954

**Shot no.:** GMX-2-465-D; GMX-8-B-3481

**Diameter:** 1.000 in.      **Average density:** 1.5650 g/cm<sup>3</sup>      **Voids:** 5%

**Fabrication:** 6-in. mold      **Unconfined**

**Booster:** 1E15 detonator

<u>Increment no.</u>	<u>Length (in.)</u>	<u>Density (g/cm<sup>3</sup>)</u>	<u>Velocity (m/s)</u>
1	2.0019	1.560	---
2	2.0018	1.5675	6838
3	2.0022	1.5665	6847
4	2.0018	1.5660	6841

**Average velocity of increments 2-4:** 6842 m/s

DETONATION VELOCITY DATA

**Material:** Atlas TNT

**Experimenter:** M. J. Urizar      **Date:** December 14, 1954

**Shot no.:** GMX-2-465-F; GMX-8-D-4914

**Diameter:** 1.500 in.      **Average density:** 1.571 g/cm<sup>3</sup>      **Voids:** 5%

**Fabrication:** 6-in. mold      **Unconfined**

**Booster:** 1E15 detonator

<u>Increment no.</u>	<u>Length (in.)</u>	<u>Density (g/cm<sup>3</sup>)</u>	<u>Velocity (m/s)</u>
1	2.0013	1.568	---
2	2.0014	1.572	6856
3	2.0007	1.572	6848
4	2.0015	1.572	6848

**Average velocity of increments 2-4:** 6851 m/s

DETONATION VELOCITY DATA

**Material:** Atlas TNT

**Experimenter:** C. L. Mader      **Date:** September 8, 1955

**Shot no.:** GMX-2-670-671-F; GMX-8-B-3763

**Diameter:** 1.625 in.      **Average density:** 1.570 g/cm<sup>3</sup>

**Fabrication:** Pressed pellets

**Booster:** 1E15 detonator and Comp B

<u>Increment no.</u>	<u>Length (in.)</u>	<u>Density (g/cm<sup>3</sup>)</u>	<u>Velocity (m/s)</u>
1	0.970	1.626	---
2	0.9696	1.626	6921
3	0.9698	1.626	6888
4	0.970	1.626	6897
5	0.9691	1.459	6536
6	0.9691	1.458	6539
7	0.969	1.459	6517
8	0.9692	1.459	6524
9	0.9695	1.626	6892
10	0.9694	1.627	7143
11	0.9698	1.626	6699
12	0.9696	1.626	6902

**Average velocity of increments 2-12:** 6769 m/s

DETONATION VELOCITY DATA

**Material:** Atlas TNT

**Experimenter:** M. J. Urizar      **Date:** March 19, 1956

**Shot no.:** GMX-2-910-A; GMX-8-B-3879

**Diameter:** 3.077 in.      **Average density:** 1.570 g/cm<sup>3</sup>      **Voids:** 5.1%

**Fabrication:** Machined to fit tubes

**Booster:** 1E15 detonator and Comp B

<u>Increment no.</u>	<u>Length (in.)</u>	<u>Density (g/cm<sup>3</sup>)</u>	<u>Velocity (m/s)</u>
1	6.001	1.578	6830
2	6.001	1.567	6829
3	6.002	1.571	6831
4	6.002	1.572	6832
5	6.001	1.567	6831
6	6.002	1.568	6833
7	6.000	1.569	6836
8	6.000	1.570	6834
9	6.002	1.568	6835

**Average velocity of increments 1-9:** 6832 m/s



DETONATION VELOCITY DATA

**Material:** Atlas TNT

**Experimenter:** M. J. Urizar      **Date:** December 14, 1954

**Shot no.:** GMX-2-465-C; GMX-8-B-3482

**Diameter:** 1.000 in.      **Average density:** 1.5779 g/cm<sup>3</sup>      **Voids:** 5%

**Fabrication:** 6-in. mold      **Unconfined**

**Booster:** 1E15 detonator

<u>Increment no.</u>	<u>Length (in.)</u>	<u>Density (g/cm<sup>3</sup>)</u>	<u>Velocity (m/s)</u>
1	2.0018	1.583	---
2	2.0015	1.576	6867
3	2.0015	1.576	6864
4	2.0013	1.5765	6873

**Average velocity of increments 2-4:** 6868 m/s

DETONATION VELOCITY DATA

Material: Atlas TNT

Experimenter: M. J. Urizar      Date: December 14, 1954

Shot no.: GMX-2-465-E; GMX-8-D-4913

Diameter: 1.500 in.      Average density: 1.5809 g/cm<sup>3</sup>      Voids: 5%

Fabrication: 6 in. mold      Unconfined

Booster: 1E15 detonator

<u>Increment no.</u>	<u>Length (in.)</u>	<u>Density (g/cm<sup>3</sup>)</u>	<u>Velocity (m/s)</u>
1	2.0013	1.583	---
2	2.0022	1.5775	6864
3	2.0020	1.5770	6852
4	2.0020	1.5760	6879

Average velocity of increments 2-4: 6865 m/s

**DETONATION VELOCITY DATA**

**Material:** Atlas TNT

**Experimenter:** M. J. Urizar      **Date:** December 14, 1954

**Shot no.:** GMX-2-465-G; GMX-8-D-4915

**Diameter:** 3.000 in.      **Average density:** 1.579 g/cm<sup>3</sup>      **Voids:** 5%

**Fabrication:** 6-in. mold      **Unconfined**

**Booster:** 1E15 detonator

<u>Increment no.</u>	<u>Length (in.)</u>	<u>Density (g/cm<sup>3</sup>)</u>	<u>Velocity (m/s)</u>
1	2.0012	1.586	---
2	2.0012	1.5755	6845
3	2.0012	1.5765	6864
4	2.0012	1.5765	6854

**Average velocity of increments 2-4:** 6854 m/s

DETONATION VELOCITY DATA

**Material:** Atlas granular TNT

**Experimenter:** E. James, Jr.      **Date:** July 20, 1955

**Shot no.:** GMX-2-680E(1); GMX-8-B-3670

**Diameter:** 0.333 in.      **Average density:** 1.5990 g/cm<sup>3</sup>      **Voids:** 1.5%

**Booster:** 1E15 detonator and Comp B

<u>Increment no.</u>	<u>Length (in.)</u>	<u>Density (g/cm<sup>3</sup>)</u>	<u>Velocity (m/s)</u>
1	1.9994	1.5984	6863
2	1.9998	1.6037	6870
3	1.9993	1.6016	6859
4	2.0001	1.6015	6865
5	1.999	1.6027	6866
6	1.9993	1.5966	6856
7	1.9993	1.5948	6849
8	1.9993	1.5923	6847

**Average velocity of increments 1-8:** 6859 m/s

DETONATION VELOCITY DATA

**Material:** Atlas TNT

**Experimenter:** C. L. Mader      **Date:** September 8, 1955

**Shot no.:** GMX-2-670-671-C; GMX-8-B-3767

**Diameter:** 1.625 in.      **Average density:** 1.600 g/cm<sup>3</sup>

**Fabrication:** Pressed pellets

**Booster:** 1E15 detonator and Comp B

<u>Increment no.</u>	<u>Length (in.)</u>	<u>Density (g/cm<sup>3</sup>)</u>	<u>Velocity (m/s)</u>
1	0.968	1.632	---
2	0.9716	1.621	6533
3	0.9716	1.623	7067
4	0.9702	1.626	6768
5	0.970	1.626	6563
6	0.9705	1.458	6910
7	0.970	1.626	6895
8	0.9708	1.457	6864
9	0.970	1.626	6603
10	0.971	1.457	6601
11	0.970	1.626	6882
12	0.971	1.456	6517
13	0.9698	1.626	7135
14	0.9769	1.456	6400
15	0.970	1.626	6907
16	0.9705	1.455	6542

**Average velocity of increments 2-16:** 6746 m/s

DETONATION VELOCITY DATA

**Material:** Atlas TNT

**Experimenter:** C. L. Mader      **Date:** September 8, 1955

**Shot no.:** GMX-2-670-671-B; GMX-8-B-3764

**Diameter:** 1.625 in.      **Average density:** 1.611 g/cm<sup>3</sup>

**Fabrication:** Pressed pellets

**Booster:** 1E15 detonator and Comp B

<u>Increment no.</u>	<u>Length (in.)</u>	<u>Density (g/cm<sup>3</sup>)</u>	<u>Velocity (m/s)</u>
1	0.970	1.626	6906
2	0.970	1.626	6912
3	0.970	1.626	6866
4	0.970	1.626	6888
5	0.970	1.626	6579
6	0.970	1.626	6989
7	0.970	1.626	6836
8	0.971	1.456	6889
9	0.971	1.626	7394
10	0.970	1.626	6821
11	0.970	1.626	6606

**Average velocity of increments 1-11:** 6881 m/s

DETONATION VELOCITY DATA

**Material:** Atlas TNT

**Experimenter:** M. J. Urizar      **Date:** December 15, 1954

**Shot no.:** GMX-2-457-A; GMX-8-B-3478

**Diameter:** 0.750 in.      **Average density:** 1.624 g/cm<sup>3</sup>      **Voids:** 1.75%

**Fabrication:** 6-in. mold      **Unconfined**

**Booster:** 1E15 detonator

<u>Increment no.</u>	<u>Length (in.)</u>	<u>Density (g/cm<sup>3</sup>)</u>	<u>Velocity (m/s)</u>
1	2.0008	1.622	---
2	2.0005	1.625	6938
3	2.0012	1.625	6951
4	2.0010	1.625	6946

**Average velocity of increments 2-4:** 6945 m/s

DETONATION VELOCITY DATA

Material: Atlas TNT

Experimenter: M. J. Urizar Date: October 25, 1955

Shot no.: GMX-2-822-H; GMX-8-B-3810

Diameter: 0.768 in. Average density: 1.621 g/cm<sup>3</sup> Voids: 1.1%

Fabrication: Machined from large pressings

Booster: 1E15 detonator and Comp B

<u>Increment no.</u>	<u>Length (in.)</u>	<u>Density (g/cm<sup>3</sup>)</u>	<u>Velocity (m/s)</u>
1	3.000	1.615	---
2	3.000	1.617	6916
3	3.000	1.618	6920
4	3.000	1.618	6924
5	3.000	1.618	6926
6	3.000	1.619	6928
7	3.000	1.621	6928
8	3.000	1.623	6927
9	3.000	1.636	6942

Average velocity of increments 2-9: 6926 m/s



DETONATION VELOCITY DATA

**Material:** Atlas TNT

**Experimenter:** M. J. Urizar      **Date:** October 20, 1955

**Shot no.:** GMX-2-822-F; GMX-8-B-3807

**Diameter:** 1.025 in.      **Average density:** 1.622 g/cm<sup>3</sup>      **Voids:** 1.1%

**Fabrication:** Machined from large pressings      **Unconfined**

**Booster:** 1E15 detonator and Comp B

<u>Increment no.</u>	<u>Length (in.)</u>	<u>Density (g/cm<sup>3</sup>)</u>	<u>Velocity (m/s)</u>
1	3.000	1.635	6947
2	3.000	1.616	6913
3	3.000	1.621	6919
4	3.000	1.621	6922
5	3.000	1.616	6918
6	3.000	1.620	6927
7	3.000	1.625	6929
8	3.000	1.617	6921
9	3.000	1.625	6934

**Average velocity of increments 1-9:** 6926 m/s

DETONATION VELOCITY DATA

**Material:** Atlas TNT

**Experimenter:** M. J. Urizar      **Date:** December 13, 1954

**Shot no.:** GMX-2-457-H; GMX-8-B-3471

**Diameter:** 3.000 in.      **Average density:** 1.624 g/cm<sup>3</sup>      **Voids:** 1.75%

**Fabrication:** 6-in. mold      **Unconfined**

**Booster:** 1E15 detonator

<u>Increment no.</u>	<u>Length (in.)</u>	<u>Density (g/cm<sup>3</sup>)</u>	<u>Velocity (m/s)</u>
1	2.0018	1.625	---
2	2.0018	1.6235	6934
3	2.0022	1.624	6933
4	2.0013	1.624	6924

**Average velocity of increments 2-4:** 6930 m/s

DETONATION VELOCITY DATA

Material: Atlas granular TNT

Experimenter: E. James, Jr. Date: July 20, 1955

Shot no.: GMX-2-680-F; GMX-8-B-3673

Diameter: 0.2729-0.2731 in. Average density: 1.6287 g/cm<sup>3</sup> Voids: 1.5%

Booster: 1E15 detonator and Comp B

<u>Increment no.</u>	<u>Length (in.)</u>	<u>Density (g/cm<sup>3</sup>)</u>	<u>Velocity (m/s)</u>
1	2.0008	1.6269	6863
2	2.0009	1.6266	6956
3	2.001	1.6314	6924
4	2.0002	1.6264	6893
5	2.0005	1.6310	6899
6	2.0003	1.6316	6917
7	2.0006	1.6269	6896
8	2.0003	1.6264	6907
9	2.001	1.6307	6909

Average velocity of increments 1-9: 6907 m/s

DETONATION VELOCITY DATA

**Material:** Atlas granular TNT

**Experimenter:** E. James, Jr.      **Date:** July 20, 1955

**Shot no.:** GMX-2-680-E(2); GMX-8-B-3671

**Diameter:** 0.3328 in.      **Average density:** 1.6264 g/cm<sup>3</sup>      **Voids:** 1.5%

**Booster:** 1E15 detonator and Comp B

<u>Increment no.</u>	<u>Length (in.)</u>	<u>Density (g/cm<sup>3</sup>)</u>	<u>Velocity (m/s)</u>
1	2.0002	1.6257	6910
2	2.000	1.6255	6904
3	2.000	1.6290	6904
4	2.0001	1.6253	6908

**Average velocity of increments 1-4:** 6907 m/s

DETONATION VELOCITY DATA

**Material:** Atlas granular TNT

**Experimenter:** E. James, Jr.      **Date:** July 20, 1955

**Shot no.:** GMX-2-680-D; GMX-8-B-3669

**Diameter:** 0.4278 in.      **Average density:** 1.6276 g/cm<sup>3</sup>      **Voids:** 1.5%

**Booster:** 1E15 detonator and Comp B

<u>Increment no.</u>	<u>Length (in.)</u>	<u>Density (g/cm<sup>3</sup>)</u>	<u>Velocity (m/s)</u>
1	2.0002	1.6271	6919
2	2.000	1.6288	6919
3	1.9998	1.6278	6920
4	2.000	1.6273	6919
5	2.000	1.6273	6925
6	1.9998	1.6275	6924
7	1.9997	1.6273	6924
8	2.000	1.6290	6923
9	2.000	1.6266	6920

**Average velocity of increments 1-9:** 6921 m/s

DETONATION VELOCITY DATA

**Material:** Atlas granular TNT

**Experimenter:** E. James, Jr.      **Date:** July 20, 1955

**Shot no.:** GMX-2-680-L; GMX-8-B-3672

**Diameter:** 0.5998 in.      **Average density:** 1.6274 g/cm<sup>3</sup>      **Voids:** 1.5%

**Booster:** 1E15 detonator and Comp B

<u>Increment no.</u>	<u>Length (in.)</u>	<u>Density (g/cm<sup>3</sup>)</u>	<u>Velocity (m/s)</u>
1	2.000	1.6284	6914
2	1.9998	1.6275	6914
3	2.000	1.6281	6925
4	2.000	1.6274	6924
5	1.9999	1.6276	6921
6	2.000	1.6264	6923
7	2.000	1.6265	6922
8	2.000	1.6264	6925
9	2.000	1.6286	6925

**Average velocity of increments 1-9:** 6921 m/s

**DETONATION VELOCITY DATA**

**Material:** Atlas granular TNT

**Experimenter:** E. James, Jr.    **Date:** July 20, 1955

**Shot no.:** GMX-2-680-B; GMX-8-B-3668

**Diameter:** 1.000 in.    **Average density:** 1.6267 g/cm<sup>3</sup>    **Voids:** 1.5%

**Booster:** 1E15 detonator and Comp B

<u>Increment no.</u>	<u>Length (in.)</u>	<u>Density (g/cm<sup>3</sup>)</u>	<u>Velocity (m/s)</u>
1	2.000	1.6293	6918
2	2.0005	1.6242	6927
3	1.9997	1.6291	6920
4	2.000	1.6284	6920
5	2.0002	1.6231	6926
6	1.9997	1.6293	6936
7	2.000	1.6269	6928
8	2.000	1.6294	6928
9	2.000	1.6208	6927

**Average velocity of increments 1-9:** 6926 m/s

DETONATION VELOCITY DATA

**Material:** Atlas TNT

**Experimenter:** M. J. Urizar      **Date:** December 15, 1954

**Shot no.:** GMX-2-457-C; GMX-8-B-3476

**Diameter:** 1.000 in.      **Average density:** 1.626 g/cm<sup>3</sup>      **Voids:** 1.75%

**Fabrication:** 6-in. mold      **Unconfined**

**Booster:** 1E15 detonator

<u>Increment no.</u>	<u>Length (in.)</u>	<u>Density (g/cm<sup>3</sup>)</u>	<u>Velocity (m/s)</u>
1	2.0011	1.627	---
2	2.016	1.625	6940
3	2.0010	1.625	6940
4	2.0011	1.625	6940

**Average velocity of increments 2-4:** 6940 m/s



**DETONATION VELOCITY DATA**

**Material:** Atlas TNT

**Experimenter:** M. J. Urizar      **Date:** December 15, 1954

**Shot no.:** GMX-2-457; GMX-8-B-3473

**Diameter:** 1.500 in.      **Average density:** 1.6265 g/cm<sup>3</sup>      **Voids:** 1.75%

**Fabrication:** 6-in. mold      **Unconfined**

**Booster:** 1E15 detonator

<u>Increment no.</u>	<u>Length (in.)</u>	<u>Density (g/cm<sup>3</sup>)</u>	<u>Velocity (m/s)</u>
1	1.9996	1.633	---
2	1.9998	1.6245	6931
3	2.0002	1.6240	6942
4	2.0005	1.6245	6943

**Average velocity of increments 2-4:** 6939 m/s

DETONATION VELOCITY DATA

**Material:** Atlas TNT

**Experimenter:** M. J. Urizar      **Date:** December 15, 1954

**Shot no.:** GMX-2-457-E; GMX-8-B-3474

**Diameter:** 1.500 in.      **Average density:** 1.6314 g/cm<sup>3</sup>      **Voids:** 1.75%

**Fabrication:** 6-in. mold      **Unconfined**

**Booster:** 1E15 detonator

<u>Increment no.</u>	<u>Length (in.)</u>	<u>Density (g/cm<sup>3</sup>)</u>	<u>Velocity (m/s)</u>
1	2.0010	1.635	---
2	2.0002	1.6295	6940
3	2.0004	1.6305	6962
4	2.0005	1.6305	6946

**Average velocity of increments 2-4:** 6949 m/s

**DETONATION VELOCITY DATA**

**Material:** Atlas TNT

**Experimenter:** M. J. Urizar      **Date:** October 20, 1955

**Shot no.:** GMX-2-822-D; GMX-8-B-3805

**Diameter:** 1.539 in.      **Average density:** 1.625 g/cm<sup>3</sup>      **Voids:** 1.1%

**Fabrication:** Machined from large pressings      **Unconfined**

**Booster:** 1E15 detonator and Comp B

<u>Increment no.</u>	<u>Length (in.)</u>	<u>Density (g/cm<sup>3</sup>)</u>	<u>Velocity (m/s)</u>
1	3.000	1.617	6912
2	3.000	1.619	6915
3	3.000	1.621	6927
4	3.000	1.622	6925
5	3.000	1.623	6916
6	3.000	1.626	6929
7	3.000	1.627	6922
8	3.000	1.635	6942
9	3.000	1.635	6943

**Average velocity of increments 1-9:** 6926 m/s

DETONATION VELOCITY DATA

**Material:** Atlas TNT

**Experimenter:** C. L. Mader      **Date:** September 8, 1955

**Shot no.:** GMX-2-670-671-A; GMX-8-B-3761

**Diameter:** 1.625 in.      **Average density:** 1.626 g/cm<sup>3</sup>

**Fabrication:** Pressed pellets

**Booster:** 1E15 detonator and Comp B

<u>Increment no.</u>	<u>Length (in.)</u>	<u>Density (g/cm<sup>3</sup>)</u>	<u>Velocity (m/s)</u>
1	0.9715	1.624	---
2	0.9705	1.625	6893
3	0.9705	1.625	7047
4	0.970	1.626	6784
5	0.9702	1.626	7148
6	0.9695	1.626	6664
7	0.9706	1.625	6934
8	0.9696	1.627	6922
9	0.9698	1.627	6924
10	0.9696	1.627	7118
11	0.9698	1.626	6748

**Average velocity of increments 2-11:** 6918 m/s

**DETONATION VELOCITY DATA**

**Material:** Atlas TNT

**Experimenter:** M. J. Urizar      **Date:** December 13, 1954

**Shot no.:** GMX-2-457-G; GMX-8-B-3472

**Diameter:** 3.00 in.      **Average density:** 1.628 g/cm<sup>3</sup>      **Voids:** 1.75%

**Fabrication:** 6-in. mold      **Unconfined**

**Booster:** 1E15 detonator

<u>Increment no.</u>	<u>Length (in.)</u>	<u>Density (g/cm<sup>3</sup>)</u>	<u>Velocity (m/s)</u>
1	2.0017	1.629	---
2	2.0010	1.628	6945
3	2.0023	1.6275	6944
4	2.0013	1.628	6940

**Average velocity of increments 2-4:** 6943 m/s

DETONATION VELOCITY DATA

**Material:** Atlas granular TNT

**Experimenter:** E. James, Jr.      **Date:** July 20, 1955

**Shot no.:** GMX-2-680-A; GMX-8-B-3667

**Diameter:** 3.0002 in.      **Average density:** 1.6289 g/cm<sup>3</sup>      **Voids:** ~1.5%

**Booster:** 1E15 detonator and Comp B

<u>Increment no.</u>	<u>Length (in.)</u>	<u>Density (g/cm<sup>3</sup>)</u>	<u>Velocity (m/s)</u>
1	2.0002	1.6324	6925
2	2.0006	1.6239	6919
3	2.0005	1.6291	6919
4	2.0002	1.6263	6928
5	2.0002	1.6300	6929
6	2.0005	1.6286	6928
7	2.0003	1.6232	6930
8	2.0002	1.6311	6930
9	2.0004	1.6299	6934

**Average velocity of increments 1-9:** 6927 m/s

**DETONATION VELOCITY DATA**

**Material:** Atlas TNT

**Experimenter:** M. J. Urizar      **Date:** October 20, 1955

**Shot no.:** GMX-2-822-B; GMX-8-B-3803

**Diameter:** 3.080 in.      **Average density:** 1.628 g/cm<sup>3</sup>      **Voids:** 1.1%

**Fabrication:** Machined from large pressings

**Booster:** 1E15 detonator and Comp B

<u>Increment no.</u>	<u>Length (in.)</u>	<u>Density (g/cm<sup>3</sup>)</u>	<u>Velocity (m/s)</u>
1	6.000	1.625	---
2	6.000	1.622	6922
3	6.000	1.616	6913
4	6.000	1.624	6927
5	6.000	1.616	6914
6	6.000	1.637	6946
7	6.000	1.638	6945
8	6.000	1.636	6945
9	6.000	1.639	6948

**Average velocity of increments 2-9:** 6933 m/s

DETONATION VELOCITY DATA

**Material:** Atlas TNT

**Experimenter:** M. J. Urizar      **Date:** December 13, 1954

**Shot no.:** GMX-2-457-I; GMX-8-D-4912

**Diameter:** 5.950 in.      **Average density:** 1.625 g/cm<sup>3</sup>      **Voids:** 1.75%

**Fabrication:** 6-in. mold      **Unconfined**

**Booster:** 1E15 detonator

<u>Increment no.</u>	<u>Length (in.)</u>	<u>Density (g/cm<sup>3</sup>)</u>	<u>Velocity (m/s)</u>
1	4.003	1.627	---
2	4.003	1.627	6943
3	4.003	1.625	6942
4	3.954	1.625	6939
5	4.004	1.624	6942
6	3.978	1.624	6938

**Average velocity of increments 2-6:** 6941 m/s



DETONATION VELOCITY DATA

**Material:** Atlas TNT

**Experimenter:** M. J. Urizar      **Date:** October 25, 1955

**Shot no.:** GMX-2-822-I; GMX-8-3809

**Diameter:** 0.768 in.      **Average density:** 1.636 g/cm<sup>3</sup>      **Voids:** 1.1%

**Fabrication:** Machined to fit tubes      **Confinement:** 0.2-in. wall brass

**Booster:** 1E15 detonator and Comp B

<u>Increment no.</u>	<u>Length (in.)</u>	<u>Density (g/cm<sup>3</sup>)</u>	<u>Velocity (m/s)</u>
1	3.000	1.636	6923
2	3.000	1.635	6929
3	3.000	1.636	6930
4	3.000	1.635	6932
5	3.000	1.636	6934
6	3.000	1.637	6928
7	3.000	1.636	6934
8	3.000	1.636	6932
9	3.000	1.635	6935

**Average velocity of increments 1-9:** 6931 m/s

DETONATION VELOCITY DATA

**Material:** Atlas TNT

**Experimenter:** M. J. Urizar      **Date:** October 19, 1955

**Shot no.:** GMX-2-822-E; GMX-8-B-3808

**Diameter:** 1.025 in.      **Average density:** 1.636 g/cm<sup>3</sup>      **Voids:** 1.1%

**Fabrication:** Machined to fit tubes      **Confinement:** 0.2-in. wall brass

**Booster:** 1E15 detonator and Comp B

<u>Increment no.</u>	<u>Length (in.)</u>	<u>Density (g/cm<sup>3</sup>)</u>	<u>Velocity (m/s)</u>
1	3.000	1.635	6927
2	3.000	1.635	6933
3	3.000	1.635	6931
4	3.000	1.637	6929
5	3.000	1.636	6934
6	3.000	1.635	6932
7	3.000	1.635	6935
8	3.000	1.635	6936
9	3.000	1.637	6934

**Average velocity of increments 1-9:** 6932 m/s

DETONATION VELOCITY DATA

Material: Atlas TNT

Experimenter: M. J. Urizar Date: October 20, 1955

Shot no.: GMX-2-822-C; GMX-8-B-3806

Diameter: 1.539 in. Average density: 1.637 g/cm<sup>3</sup> Voids: 1.1%

Fabrication: Machined to fit tubes Confinement: 0.2-in. wall brass

Booster: 1E15 detonator and Comp B

<u>Increment no.</u>	<u>Length (in.)</u>	<u>Density (g/cm<sup>3</sup>)</u>	<u>Velocity (m/s)</u>
1	3.000	1.636	6927
2	3.000	1.638	6935
3	3.000	1.638	6935
4	3.000	1.641	6939
5	3.000	1.636	6944
6	3.000	1.636	6943
7	3.000	1.639	6944
8	3.000	1.635	6937
9	3.000	1.635	6934

Average velocity of increments 1-9: 6938 m/s

DETONATION VELOCITY DATA

**Material:** Atlas TNT

**Experimenter:** M. J. Urizar      **Date:** October 20, 1955

**Shot no.:** GMX-2-822-A; GMX-8-B-3804

**Diameter:** 3.080 in.      **Average density:** 1.636 g/cm<sup>3</sup>      **Voids:** 1.1%

**Fabrication:** Machined to fit tubes      **Confinement:** 0.2-in. wall brass

**Booster:** 1E15 detonator and Comp B

<u>Increment no.</u>	<u>Length (in.)</u>	<u>Density (g/cm<sup>3</sup>)</u>	<u>Velocity (m/s)</u>
1	6.000	1.628	6932
2	6.000	1.637	6940
3	6.000	1.636	6934
4	6.000	1.637	6944
5	6.000	1.636	6938
6	6.000	1.636	6944
7	6.000	1.636	6942
8	6.000	1.638	6944
9	6.000	1.638	6942

**Average velocity of increments:** 6940 m/s

DETONATION VELOCITY DATA

**Material:** 60 wt% TNT/40 wt% DNT

**Experimenter:** C. L. Mader      **Date:** February 9, 1956

**Shot no.:** GMX-2-859; GMX-8-B-3860

**Diameter:** 2.0000 in.      **Average density:** 1.3019 g/cm<sup>3</sup>

**Fabrication:** Pressed and milled

**Booster:** 1E15 detonator, P-016 lens, and 0.25-in. Comp B

<u>Increment no.</u>	<u>Length (in.)</u>	<u>Density (g/cm<sup>3</sup>)</u>	<u>Velocity (m/s)</u>
1	3.7914	1.2998	6170
2	3.7939	1.3004	5687
3	3.7937	1.2995	5686
4	3.7943	1.2997	5690
5	3.7935	1.3017	5694
6	3.7952	1.3030	5697
7	3.7933	1.3046	5709
8	3.7938	1.3042	5709
9	3.7946	1.3041	5697

**Weighted average velocity of increments 2-9:** 5695 m/s

DETONATION VELOCITY DATA

**Material:** 60 wt% TNT/40 wt% DNT

**Experimenter:** C. L. Mader      **Date:** February 10, 1956

**Shot no.:** GMX-2-859; GMX-8-B-3861

**Diameter:** 2.9988 in.      **Average density:** 1.3037 g/cm<sup>3</sup>

**Fabrication:** Pressed and milled

**Booster:** 1E15 detonator, P-016 lens, and 0.25-in. Comp B

<u>Increment no.</u>	<u>Length (in.)</u>	<u>Density (g/cm<sup>3</sup>)</u>	<u>Velocity (m/s)</u>
1	3.7962	1.3060	6329
2	3.7957	1.3049	5744
3	3.7962	1.3002	5734
4	3.7963	1.3056	5765
5	3.7965	1.3023	5753
6	3.7965	1.3038	5755
7	3.7966	1.3039	5755
8	3.7960	1.3040	5759
9	3.7960	1.3029	5742

**Weighted average velocity of increments 2-9:** 5746 m/s

**DETONATION VELOCITY DATA**

**Material:** 60 wt% TNT/40 wt% DNT

**Experimenter:** C. L. Mader      **Date:** February 8, 1956

**Shot no.:** GMX-2-859; GMX-8-B-3859

**Diameter:** 5.7974 in.      **Average density:** 1.3038 g/cm<sup>3</sup>

**Fabrication:** Pressed and milled

**Booster:** 1E22 detonator, P-040 lens, and 0.5-in. Comp B

<u>Increment no.</u>	<u>Length (in.)</u>	<u>Density (g/cm<sup>3</sup>)</u>	<u>Velocity (m/s)</u>
1	7.5964	1.3194	5950
2	7.5949	1.3023	5807
3	7.5938	1.3018	5801
4	7.5932	1.3031	5804
5	7.5943	1.3017	5806
6	7.5958	1.3026	5808
7	7.5984	1.3015	5813
8	7.5956	1.3018	5815
9	7.5960	1.3023	5794

**Weighted average velocity of increments 2-9:** 5805 m/s

## DETONATION VELOCITY DATA

**Material:** 60 wt% TNT/40 wt% DNT

**Experimenter:** C. L. Mader      **Date:** January 26, 1956

**Shot no.:** GMX-2-858; GMX-8-B-3854

**Diameter:** 1.9977 in.      **Average density:** 1.401 g/cm<sup>3</sup>

**Fabrication:** Pressed and milled

**Booster:** 1E15 detonator, P-016 lens, and 0.25-in. Comp B

<u>Increment no.</u>	<u>Length (in.)</u>	<u>Density (g/cm<sup>3</sup>)</u>	<u>Velocity (m/s)</u>
1	3.7949	1.401	6138
2	3.7946	1.402	6064
3	3.7953	1.403	6077
4	3.7931	1.402	6082
5	3.7943	1.402	6076
6	3.7942	1.401	6071
7	3.7944	1.399	6074
8	3.7939	1.401	6069
9	3.7944	1.402	6071

**Weighted average velocity of increments 2-9:** 6069 m/s



**DETONATION VELOCITY DATA**

**Material:** 60 wt% TNT/40 wt% DNT

**Experimenter:** C. L. Mader      **Date:** January 27, 1956

**Shot no.:** GMX-2-858; GMX-8-B-3855

**Diameter:** 2.9971 in.      **Average density:** 1.4021 g/cm<sup>3</sup>

**Fabrication:** Pressed and milled

**Booster:** 1E15 detonator, P-016 lens, and 0.25-in. Comp B

<u>Increment no.</u>	<u>Length (in.)</u>	<u>Density (g/cm<sup>3</sup>)</u>	<u>Velocity (m/s)</u>
1	3.7933	1.4049	6183
2	3.7946	1.4034	6084
3	3.7940	1.4037	6114
4	3.7938	1.4011	6013
5	3.7944	1.4022	6105
6	3.7942	1.4034	6029
7	3.7949	1.4026	6110
8	3.7937	1.4025	6017
9	3.7946	1.4020	6105

**Weighted average velocity of increments 2-9:** 6103 m/s

DETONATION VELOCITY DATA

**Material:** 60 wt% TNT/40 wt% DNT

**Experimenter:** C. L. Mader      **Date:** January 25, 1956

**Shot no.:** GMX-2-858; GMX-8-B-3853

**Diameter:** 5.7987 in.      **Average density:** 1.401 g/cm<sup>3</sup>

**Fabrication:** Pressed and milled

**Booster:** 1E22 detonator, P-040 lens, and 0.5-in. Comp B

Increment no.	Length (in.)	Density (g/cm <sup>3</sup> )	Velocity (m/s)
1	7.5946	1.4065	6223
2	{ 15.1880	{ 1.4017	{ 6136
3			
4	7.5940	1.4000	6128
5	7.5872	1.3997	6133
6	7.5936	1.4001	6131
7	7.5952	1.3991	6131
8	7.5954	1.3985	6131
9	7.5941	1.3990	6126

**Weighted average velocity of increments 2-9:** 6134 m/s

**DETONATION VELOCITY DATA**

**Material:** 60 wt% TNT/40 wt% DNT

**Experimenter:** C. L. Mader      **Date:** January 12, 1956

**Shot no.:** GMX-2-857; GMX-8-B-3847

**Diameter:** 1.9993 in.      **Average density:** 1.4950 g/cm<sup>3</sup>

**Fabrication:** Pressed and milled

**Booster:** 1E15 detonator, P-016 lens, and 0.25-in. Comp B

<u>Increment no.</u>	<u>Length (in.)</u>	<u>Density (g/cm<sup>3</sup>)</u>	<u>Velocity (m/s)</u>
1	3.7949	1.4943	6630
2	3.7947	1.4968	6410
3	3.7944	1.4942	6422
4	3.7948	1.4965	6428
5	3.7960	1.4940	6427
6	3.7948	1.4953	6426
7	3.7957	1.4951	6422
8	3.7949	1.4947	6421
9	3.7952	1.4943	6004

**Weighted average velocity of increments 2-8:** 6424 m/s

DETONATION VELOCITY DATA

Material: 60 wt% TNT/40 wt% DNT

Experimenter: C. L. Mader Date: January 13, 1956

Shot no.: GMX-2-857; GMX-8-B-3848

Diameter: 2.9992 in. Average density: 1.4958 g/cm<sup>3</sup>

Fabrication: Pressed and milled

Booster: 1E15 detonator, P-016 lens, and 0.25-in. Comp B

<u>Increment no.</u>	<u>Length (in.)</u>	<u>Density (g/cm<sup>3</sup>)</u>	<u>Velocity (m/s)</u>
1	3.7966	1.4980	6496
2	3.7961	1.4978	6429
3	3.7963	1.4973	6443
4	3.7960	1.4961	6448
5	3.7960	1.4928	6438
6	3.7959	1.4959	6446
7	3.7962	1.4950	6441
8	3.7961	1.4942	6445
9	3.7957	1.4949	6442

Weighted average velocity of increments 3-9: 6442 m/s

DETONATION VELOCITY DATA

Material: 60 wt% TNT/40 wt% DNT

Experimenter: C. L. Mader Date: January 11, 1956

Shot no.: GMX-2-857; GMX-8-B-3846

Diameter: 5.79806 in. Average density: 1.4943 g/cm<sup>3</sup>

Fabrication: Pressed and milled

Booster: 1E22 detonator, P-040 lens, and 0.5-in. Comp B

<u>Increment no.</u>	<u>Length (in.)</u>	<u>Density (g/cm<sup>3</sup>)</u>	<u>Velocity (m/s)</u>
1	3.5975	1.4960	6512
2	3.5929	1.4944	6461
3	3.5967	1.4945	6459
4	3.5980	1.4937	6464
5	3.5969	1.4940	6463
6	3.5955	1.4945	6463
7	3.5972	1.4932	6463
8	3.5975	1.4942	6465
9	3.5982	1.4940	6462

Weighted average velocity of increments 2-9: 6465 m/s

## DETONATION VELOCITY DATA

**Material:** 33.3 wt% TNT/33.3 wt% PETN/33.3 wt% tetryl

**Experimenter:** E. James, Jr.     **Date:** November 23, 1953

**Shot no.:** GMX-3-C-105C; GMX-8-B-2887

**Diameter:** ~ 2 in.     **Average density:** 1.644 g/cm<sup>3</sup>

**Fabrication:** Poured at 100°C

**Booster:** 1E15 detonator and self-boostering

<u>Increment no.</u>	<u>Length (in.)</u>	<u>Density (g/cm<sup>3</sup>)</u>	<u>Velocity (m/s)</u>
1	~1.6	---	---
2	~1.6	---	---
3	1.686	1.653	7411
4	1.580	1.635	7374

**Average velocity of increments 3 and 4:** 7393 m/s

**DETONATION VELOCITY DATA**

**Material:** 33.3 wt% TNT/33.3 wt% PETN/33.3 wt% tetryl

**Experimenter:** E. James, Jr.      **Date:** November 23, 1953

**Shot no.:** GMX-2-C-105B; GMX-8-B-2888

**Diameter:** ~ 2 in.      **Average density:** 1.661 g/cm<sup>3</sup>

**Fabrication:** Poured at 60°C

**Booster:** 1E15 detonator and self-boostering

<u>Increment no.</u>	<u>Length (in.)</u>	<u>Density (g/cm<sup>3</sup>)</u>	<u>Velocity (m/s)</u>
1	~1.8	---	---
2	~1.8	---	---
3	1.805	1.662	7456
4	1.892	1.659	7336

**Average velocity of increments 3 and 4:** 7396 m/s

DETONATION VELOCITY DATA

**Material:** 80 wt% TNT/20 wt% RDX

**Experimenter:** M. J. Urizar      **Date:** June 18, 1954

**Shot no.:** GMX-2-299-2; GMX-8-D-4600

**Diameter:** 0.75 in.      **Average density:** 1.201 g/cm<sup>3</sup>      **Voids:** 28.7%

**Fabrication:** Pressed into tubes      **Confinement:** 0.085-in. polystyrene

**Booster:** 1E15 detonator

<u>Increment no.</u>	<u>Length (in.)</u>	<u>Density (g/cm<sup>3</sup>)</u>	<u>Velocity (m/s)</u>
1	3.000	1.201	---
2	3.000	1.200	---
3	3.000	1.201	5711
4	3.000	1.201	5731

**Average velocity of increments 3 and 4:** 5721 m/s



DETONATION VELOCITY DATA

Material: 80 wt% TNT/20 wt% RDX

Experimenter: M. J. Urizar Date: September 22, 1954

Shot no.: GMX-2-371-A; GMX-8-B-3299

Diameter: 0.75 in. Average density: 1.201 g/cm<sup>3</sup> Voids: 28.7%

Fabrication: Pressed into tubes Confinement: 0.085-in. polystyrene

Booster: 1E15 detonator

<u>Increment no.</u>	<u>Length (in.)</u>	<u>Density (g/cm<sup>3</sup>)</u>	<u>Velocity (m/s)</u>
1	3.000	1.201	—
2	3.000	1.201	5718
3	3.000	1.200	5737
4	3.000	1.200	5722

Average velocity of increments 2-4: 5726 m/s

DETONATION VELOCITY DATA

**Material:** 80 wt% TNT/20 wt% RDX

**Experimenter:** M. J. Urizar    **Date:** September 22, 1954

**Shot no.:** GMX-2-371-B; GMX-8-B-3298

**Diameter:** 1.0 in.    **Average density:** 1.200 g/cm<sup>3</sup>    **Voids:** 28.7%

**Fabrication:** Pressed into tubes    **Confinement:** 0.085-in. polystyrene

**Booster:** 1E15 detonator

<u>Increment no.</u>	<u>Length (in.)</u>	<u>Density (g/cm<sup>3</sup>)</u>	<u>Velocity (m/s)</u>
1	3.000	1.200	5736
2	3.000	1.200	5748
3	3.000	1.200	5794

**Average velocity of increments 1-3:** 5759 m/s

**DETONATION VELOCITY DATA**

**Material:** 80 wt% TNT/20 wt% RDX

**Experimenter:** M. J. Urizar      **Date:** June 17, 1954

**Shot no.:** GMX-2-299-4; GMX-8-D-4601

**Diameter:** 1 in.      **Average density:** 1.201 g/cm<sup>3</sup>      **Voids:** 28.7%

**Fabrication:** Pressed into tubes      **Confinement:** 0.085-in. polystyrene

**Booster:** 1E15 detonator

<u>Increment no.</u>	<u>Length (in.)</u>	<u>Density (g/cm<sup>3</sup>)</u>	<u>Velocity (m/s)</u>
1	3.000	1.201	---
2	3.000	1.200	5771
3	3.000	1.201	5781
4	3.000	1.201	5788

**Average velocity of increments 2-4:** 5780 m/s

## DETONATION VELOCITY DATA

**Material:** 80 wt% TNT/20 wt% RDX

**Experimenter:** M. J. Urizar      **Date:** June 17, 1954

**Shot no.:** GMX-2-299-3; GMX-8-D-4599

**Diameter:** 1 in.      **Average density:** 1.201 g/cm<sup>3</sup>      **Voids:** 28.7%

**Fabrication:** Pressed into tubes      **Confinement:** 0.085-in. polystyrene

**Booster:** 1E15 detonator

<u>Increment no.</u>	<u>Length (in.)</u>	<u>Density (g/cm<sup>3</sup>)</u>	<u>Velocity (m/s)</u>
1	3.000	1.201	---
2	3.000	1.201	5821
3	3.000	1.201	5801
4	3.000	1.201	---

**Average velocity of increments 2 and 3:** 5811 m/s

**DETONATION VELOCITY DATA**

**Material:** 80 wt% TNT/20 wt% RDX

**Experimenter:** M. J. Urizar      **Date:** June 17, 1954

**Shot no.:** GMX-2-299-5; GMX-8-D-4604

**Diameter:** 1.5 in.      **Average density:** 1.201 g/cm<sup>3</sup>      **Voids:** 28.7%

**Fabrication:** Pressed into tubes      **Confinement:** 0.085-in. polystyrene

**Booster:** 1E15 detonator

<u>Increment no.</u>	<u>Length (in.)</u>	<u>Density (g/cm<sup>3</sup>)</u>	<u>Velocity (m/s)</u>
1	3.000	1.200	---
2	3.000	1.201	5866
3	3.000	1.200	5838
4	3.000	1.201	5868

**Average velocity of increments 2-4:** 5857 m/s

DETONATION VELOCITY DATA

**Material:** 80 wt% TNT/20 wt% RDX

**Experimenter:** M. J. Urizar      **Date:** June 17, 1954

**Shot no.:** GMX-2-299-6; GMX-8-D-4603

**Diameter:** 1.5 in.      **Average density:** 1.200 g/cm<sup>3</sup>      **Voids:** 28.7%

**Fabrication:** Pressed into tubes      **Confinement:** 0.085-in. polystyrene

**Booster:** 1E15 detonator

<u>Increment no.</u>	<u>Length (in.)</u>	<u>Density (g/cm<sup>3</sup>)</u>	<u>Velocity (m/s)</u>
1	3.000	1.200	---
2	3.000	1.200	5849
3	3.000	1.200	5855
4	3.000	1.200	5920

**Average velocity of increments 2-4:** 5875 m/s

DETONATION VELOCITY DATA

**Material:** 80 wt% TNT/20 wt% RDX

**Experimenter:** M. J. Urizar      **Date:** September 22, 1954

**Shot no.:** GMX-2-371-C; GMX-8-B-3295

**Diameter:** 1.5 in.      **Average density:** 1.202 g/cm<sup>3</sup>      **Voids:** 28.7%

**Fabrication:** Pressed into tubes      **Confinement:** 0.085-in. polystyrene

**Booster:** 1E15 detonator

<u>Increment no.</u>	<u>Length (in.)</u>	<u>Density (g/cm<sup>3</sup>)</u>	<u>Velocity (m/s)</u>
1	3.000	1.207	---
2	3.000	1.200	5808
3	3.000	1.200	5966
4	3.000	1.200	5898

**Average velocity of increments 2-4:** 5891 m/s

DETONATION VELOCITY DATA

Material: 80 wt% TNT/20 wt% RDX

Experimenter: M. J. Urizar Date: September 22, 1954

Shot no.: GMX-2-371-D; GMX-8-B-3301

Diameter: 3 in. Average density: 1.200 g/cm<sup>3</sup> Voids: 28.7%

Fabrication: Pressed into tubes Confinement: 0.25-in. Lucite

Booster: 1E15 detonator

<u>Increment no.</u>	<u>Length (in.)</u>	<u>Density (g/cm<sup>3</sup>)</u>	<u>Velocity (m/s)</u>
1	6.000	1.199	---
2	6.000	1.200	5901
3	6.000	1.200	5908
4	6.000	1.200	5901

Average velocity of increments 2-4: 5903 m/s



**DETONATION VELOCITY DATA**

**Material:** 80 wt% TNT/20 wt% RDX

**Experimenter:** M. J. Urizar      **Date:** June 17, 1954

**Shot no.:** GMX-2-299-7; GMX-8-D-4605

**Diameter:** 3 in.      **Average density:** 1.200 g/cm<sup>3</sup>      **Voids:** 28.7%

**Fabrication:** Pressed into tubes      **Confinement:** 0.025-in. Lucite

**Booster:** 1E15 detonator

<u>Increment no.</u>	<u>Length (in.)</u>	<u>Density (g/cm<sup>3</sup>)</u>	<u>Velocity (m/s)</u>
1	6.000	1.201	---
2	6.000	1.201	5934
3	6.000	1.199	5894
4	6.000	1.200	5908

**Average velocity of increments 2-4:** 5912 m/s

DETONATION VELOCITY DATA

Material: 80 wt% TNT/20 wt% RDX

Experimenter: M. J. Urizar Date: June 17, 1954

Shot no.: GMX-2-299-8; GMX-8-D-4606

Diameter: 3 in. Average density: 1.202 g/cm<sup>3</sup> Voids: 28.7%

Fabrication: Pressed into tubes Confinement: 0.025-in. Lucite

Booster: 1E15 detonator

<u>Increment no.</u>	<u>Length (in.)</u>	<u>Density (g/cm<sup>3</sup>)</u>	<u>Velocity (m/s)</u>
1	6.000	1.202	---
2	6.000	1.203	5946
3	6.000	1.201	5920
4	6.000	1.201	5904

Average velocity of increments 2-4: 5923 m/s

**DETONATION VELOCITY DATA**

**Material:** 60 wt% TNT/40 wt% RDX

**Experimenter:** M. J. Urizar     **Date:** June 21, 1954

**Shot no.:** GMX-2-300-1; GMX-8-D-4619

**Diameter:** 0.75 in.     **Average density:** 1.201 g/cm<sup>3</sup>     **Voids:** 30%

**Fabrication:** Pressed into tubes     **Confinement:** 0.085-in. polystyrene

**Booster:** 1E15 detonator

<u>Increment no.</u>	<u>Length (in.)</u>	<u>Density (g/cm<sup>3</sup>)</u>	<u>Velocity (m/s)</u>
1	3.000	1.201	---
2	3.000	1.201	6004
3	3.000	1.201	5997
4	3.000	1.201	--

**Average velocity of increments 2 and 3:** 6001 m/s

DETONATION VELOCITY DATA

**Material:** 60 wt% TNT/40 wt% RDX

**Experimenter:** M. J. Urizar      **Date:** June 21, 1954

**Shot no.:** GMX-2-300-2; GMX-8-D-4620

**Diameter:** 0.75 in.      **Average density:** 1.201 g/cm<sup>3</sup>      **Voids:** 30%

**Fabrication:** Pressed into tubes      **Confinement:** 0.085-in. polystyrene

**Booster:** 1E15 detonator

<u>Increment no.</u>	<u>Length (in.)</u>	<u>Density (g/cm<sup>3</sup>)</u>	<u>Velocity (m/s)</u>
1	3.000	1.201	--
2	3.000	1.201	6007
3	3.000	1.201	6012
4	3.000	1.201	5997

**Average velocity of increments 2-4:** 6005 m/s

DETONATION VELOCITY DATA

Material: 60 wt% TNT/40 wt% RDX

Experimenter: M. J. Urizar Date: September 22, 1954

Shot no.: GMX-2-370-A; GMX-8-B-3300

Diameter: 0.75 in. Average density: 1.201 g/cm<sup>3</sup> Voids: 29.95%

Fabrication: Pressed into tubes Confinement: 0.085-in. polystyrene

Booster: 1E15 detonator

<u>Increment no.</u>	<u>Length (in.)</u>	<u>Density (g/cm<sup>3</sup>)</u>	<u>Velocity (m/s)</u>
1	3.000	1.201	---
2	3.000	1.201	6054
3	3.000	1.200	6036
4	3.000	1.200	6007

Average velocity of increments 2-4: 6032 m/s

DETONATION VELOCITY DATA

**Material:** 60 wt% TNT/40 wt% RDX

**Experimenter:** M. J. Urizar      **Date:** June 21, 1954

**Shot no.:** GMX-2-300-3; GMX-8-D-4618

**Diameter:** 1 in.      **Average density:** 1.200 g/cm<sup>3</sup>      **Voids:** 30%

**Fabrication:** Pressed into tubes      **Confinement:** 0.085-in. polystyrene

**Booster:** 1E15 detonator

<u>Increment no.</u>	<u>Length (in.)</u>	<u>Density (g/cm<sup>3</sup>)</u>	<u>Velocity (m/s)</u>
1	3.000	1.200	--
2	3.000	1.200	6048
3	3.000	1.200	6027
4	3.000	1.200	6040

**Average velocity of increments 2-4:** 6038 m/s

DETONATION VELOCITY DATA

**Material:** 60 wt% TNT/40 wt% RDX

**Experimenter:** M. J. Urizar      **Date:** June 21, 1954

**Shot no.:** GMX-2-300-4; GMX-8-D-4617

**Diameter:** 1 in.      **Average density:** 1.201 g/cm<sup>3</sup>      **Voids:** 30%

**Fabrication:** Pressed into tubes      **Confinement:** 0.085-in. polystyrene

**Booster:** 1E15 detonator

<u>Increment no.</u>	<u>Length (in.)</u>	<u>Density (g/cm<sup>3</sup>)</u>	<u>Velocity (m/s)</u>
1	3.000	1.200	--
2	3.000	1.201	6042
3	3.000	1.200	6032
4	3.000	1.201	6043

**Average velocity of increments 2-4:** 6039 m/s

## DETONATION VELOCITY DATA

**Material:** 60 wt% TNT/40 wt% RDX

**Experimenter:** M. J. Urizar      **Date:** June 21, 1954

**Shot no.:** GMX-2-300-5; GMX-8-D-4616

**Diameter:** 1.5 in.      **Average density:** 1.200 g/cm<sup>3</sup>      **Voids:** 30%

**Fabrication:** Pressed into tubes      **Confinement:** 0.085-in. polystyrene

**Booster:** 1E15 detonator

<u>Increment no.</u>	<u>Length (in.)</u>	<u>Density (g/cm<sup>3</sup>)</u>	<u>Velocity (m/s)</u>
1	3.000	1.200	---
2	3.000	1.200	6149
3	3.000	1.199	6081
4	3.000	1.200	6061

**Average velocity of increments 2-4:** 6097 m/s



**DETONATION VELOCITY DATA**

**Material:** 60 wt% TNT/40 wt% RDX

**Experimenter:** M. J. Urizar      **Date:** June 21, 1954

**Shot no.:** GMX-2-300-6; GMX-8-D-4615

**Diameter:** 1.5 in.      **Average density:** 1.200 g/cm<sup>3</sup>      **Voids:** 30%

**Fabrication:** Pressed into tubes      **Confinement:** 0.085-in. polystyrene

**Booster:** 1E15 detonator

<u>Increment no.</u>	<u>Length (in.)</u>	<u>Density (g/cm<sup>3</sup>)</u>	<u>Velocity (m/s)</u>
1	3.000	1.200	---
2	3.000	1.200	6110
3	3.000	1.199	6126
4	3.000	1.200	6096

**Average velocity of increments 2-4:** 6111 m/s

DETONATION VELOCITY DATA

**Material:** 60 wt% TNT/40 wt% RDX

**Experimenter:** M. J. Urizar      **Date:** June 18, 1954

**Shot no.:** GMX-2-300-7; GMX-8-D-4622

**Diameter:** 3 in.      **Average density:** 1.201 g/cm<sup>3</sup>      **Voids:** 30%

**Fabrication:** Pressed into tubes      **Confinement:** 0.085-in. polystyrene

**Booster:** 1E15 detonator

<u>Increment no.</u>	<u>Length (in.)</u>	<u>Density (g/cm<sup>3</sup>)</u>	<u>Velocity (m/s)</u>
1	6.000	1.201	---
2	6.000	1.201	6158
3	6.000	1.200	6191
4	6.000	1.203	6144

**Average velocity of increments 2-4:** 6164 m/s

DETONATION VELOCITY DATA

Material: 60 wt% TNT/40 wt% RDX

Experimenter: M. J. Urizar Date: June 18, 1954

Shot no.: GMX-2-300-8; GMX-8-D-4621

Diameter: 3 in. Average density: 1.201 g/cm<sup>3</sup> Voids: 30%

Fabrication: Pressed into tubes Confinement: 0.085-in. polystyrene

Booster: 1E15 detonator and P-040 lens

<u>Increment no.</u>	<u>Length (in.)</u>	<u>Density (g/cm<sup>3</sup>)</u>	<u>Velocity (m/s)</u>
1	6.000	1.201	---
2	6.000	1.200	6185
3	6.000	1.201	6149
4	6.000	1.200	6157

Average velocity of increments 2-4: 6164 m/s

DETONATION VELOCITY DATA

**Material:** 57.1 wt% TNT/42.9 wt% RDX

**Experimenter:** J. B. Panowski    **Date:** May 21, 1954

**Shot no.:** GMX-2-285-21 through -285-25; GMX-8-B-3190

**Diameter:** 1 in.    **Average density:** 1.631 g/cm<sup>3</sup>

**Booster:** 1E15 detonator and 2.000-in.-long Comp B

<u>Increment no.</u>	<u>Length (in.)</u>	<u>Density (g/cm<sup>3</sup>)</u>	<u>Velocity (m/s)</u>
1	2.000	1.631	---
2	2.000	1.619	7375
3	2.000	1.625	7409
4	2.000	1.630	7410
5	2.000	1.649	7434

**Average velocity of increments 2-5:** 7407 m/s

DETONATION VELOCITY DATA

**Material:** 57.1 wt% TNT/42.9 wt% RDX

**Experimenter:** J. B. Panowski      **Date:** May 21, 1954

**Shot no.:** GMX-2-285-11 through -285-15; GMX-8-B-3193

**Diameter:** 0.666 in.      **Average density:** 1.635 g/cm<sup>3</sup>

**Booster:** 1E15 detonator and 2.000-in.-long Comp B

<u>Increment no.</u>	<u>Length (in.)</u>	<u>Density (g/cm<sup>3</sup>)</u>	<u>Velocity (m/s)</u>
1	2.000	1.634	---
2	2.000	1.647	7430
3	2.000	1.642	7460
4	2.000	1.634	7380
5	2.000	1.617	7395

**Average velocity of increments 2-5:** 7416 m/s

DETONATION VELOCITY DATA

**Material:** 57.1 wt% TNT/42.9 wt% RDX

**Experimenter:** J. B. Panowski     **Date:** May 21, 1954

**Shot no.:** GMX-2-285-16 through 285-20; GMX-8-B-3214

**Diameter:** 0.666 in.     **Average density:** 1.636 g/cm<sup>3</sup>

**Booster:** 1E15 detonator and 2.000-in.-long Comp B

<u>Increment no.</u>	<u>Length (in.)</u>	<u>Density (g/cm<sup>3</sup>)</u>	<u>Velocity (m/s)</u>
1	2.000	1.642	---
2	2.000	1.643	7417
3	2.000	1.650	7425
4	2.000	1.635	7379
5	2.000	1.611	7393

**Average velocity of increments 2-5:** 7404 m/s

**DETONATION VELOCITY DATA**

**Material:** 57.1 wt% TNT/42.9 wt% RDX

**Experimenter:** J. B. Panowski      **Date:** May 21, 1954

**Shot no.:** GMX-2-285-26 through 285-30; GMX-8-B-3209

**Diameter:** 1 in.      **Average density:** 1.639 g/cm<sup>3</sup>

**Booster:** 1E15 detonator and 2-in.-long Comp B

<u>Increment no.</u>	<u>Length (in.)</u>	<u>Density (g/cm<sup>3</sup>)</u>	<u>Velocity (m/s)</u>
1	2.000	1.645	---
2	2.000	1.620	7404
3	2.000	1.645	7414
4	2.000	1.638	7429
5	2.000	1.646	7416

**Average velocity of increments 2-5:** 7416 m/s

## DETONATION VELOCITY DATA

**Material:** 57.1 wt% TNT/42.9 wt% RDX

**Experimenter:** J. B. Panowski      **Date:** May 20, 1954

**Shot no.:** GMX-2-285-1 through -285-5; GMX-8-B-3187

**Diameter:** 2 in.      **Average density:** 1.642 g/cm<sup>3</sup>

**Booster:** 1E15 detonator and 1.994-in.-long Comp B

<u>Increment no.</u>	<u>Length (in.)</u>	<u>Density (g/cm<sup>3</sup>)</u>	<u>Velocity (m/s)</u>
1	1.994	---	---
2	1.994	1.642	7349
3	1.994	1.643	7470
4	1.994	1.649	7418
5	1.994	1.635	7357

**Average velocity of increments 2-5:** 7399 m/s



DETONATION VELOCITY DATA

**Material:** 57.1 wt% TNT/42.9 wt% RDX

**Experimenter:** J. B. Panowski      **Date:** May 20, 1954

**Shot no.:** GMX-2-285-6 through 285-10; GMX-8-B-3208

**Diameter:** 2 in.      **Average density:** 1.645 g/cm<sup>3</sup>

**Booster:** 1E15 detonator and 1.995-in.-long Comp B

<u>Increment no.</u>	<u>Length (in.)</u>	<u>Density (g/cm<sup>3</sup>)</u>	<u>Velocity (m/s)</u>
1	1.995	1.650	---
2	1.995	1.640	7420
3	1.995	1.636	7318
4	1.995	1.650	7438
5	1.994	1.651	7432

**Average velocity of increments 2-5:** 7402 m/s

DETONATION VELOCITY DATA

**Material:** 57.1 wt% TNT/42.9 wt% RDX

**Experimenter:** J. B. Panowski      **Date:** March 31, 1954

**Shot no.:** GMX-2-14-A; GMX-8-B-3115

**Diameter:** 1.625 in.      **Average density:** 1.657 g/cm<sup>3</sup>

**Booster:** 1E15 detonator and Comp B

<u>Increment no.</u>	<u>Length (in.)</u>	<u>Density (g/cm<sup>3</sup>)</u>	<u>Velocity (m/s)</u>
1	3.750	1.647	---
2	3.750	1.656	7487
3	3.750	1.658	7517
4	3.750	1.667	7557

**Average velocity of increments 2-4:** 7520 m/s

**DETONATION VELOCITY DATA**

**Material:** 48.6 wt% TNT/36.4 wt% RDX/15.0 wt% ammonium perchlorate

**Experimenter:** J. B. Panowski      **Date:** May 21, 1954

**Shot no.:** GMX-2-284-21 through -284-25; GMX-8-B-3189

**Diameter:** 1 in.      **Average density:** 1.675 g/cm<sup>3</sup>

**Booster:** 1E15 detonator and 2.000-in.-long Comp B

<u>Increment no.</u>	<u>Length (in.)</u>	<u>Density (g/cm<sup>3</sup>)</u>	<u>Velocity (m/s)</u>
1	2.000	1.657	---
2	2.000	1.691	7294
3	2.000	1.689	7335
4	2.000	1.678	7280
5	2.000	1.660	7241

**Average velocity of increments 2-5:** 7288 m/s

DETONATION VELOCITY DATA

**Material:** 48.6 wt% TNT/36.4 wt% RDX/15 wt% ammonium perchlorate

**Experimenter:** J. B. Panowski      **Date:** May 21, 1954

**Shot no.:** GMX-2-284-16 through 284-20; GMX-8-B-3212

**Diameter:** 0.666 in.      **Average density:** 1.690 g/cm<sup>3</sup>

**Booster:** 1E15 detonator and Comp B

<u>Increment no.</u>	<u>Length (in.)</u>	<u>Density (g/cm<sup>3</sup>)</u>	<u>Velocity (m/s)</u>
1	2.000	1.680	---
2	2.000	1.689	7242
3	2.000	1.693	7254
4	2.000	1.693	7243
5	2.000	1.693	7249

**Average velocity of increments 2-5:** 7247 m/s

**DETONATION VELOCITY DATA**

**Material:** 48.6 wt% TNT/36.4 wt% RDX/15.0 wt% ammonium perchlorate

**Experimenter:** J. B. Panowski      **Date:** May 21, 1954

**Shot no.:** GMX-2-284-11 through -284-15; GMX-8-B-3191

**Diameter:** 0.666 in.      **Average density:** 1.691 g/cm<sup>3</sup>

**Booster:** 1E15 detonator and 2.000-in.-long Comp B

<u>Increment no.</u>	<u>Length (in.)</u>	<u>Density (g/cm<sup>3</sup>)</u>	<u>Velocity (m/s)</u>
1	2.000	1.689	---
2	2.000	1.691	7271
3	2.000	1.693	7258
4	2.000	1.681	7234
5	2.000	1.700	7277

**Average velocity of increments 2-5:** 7260 m/s

DETONATION VELOCITY DATA

**Material:** 48.6 wt% TNT/36.4 wt% RDX/15.0 wt% ammonium perchlorate

**Experimenter:** J. B. Panowski      **Date:** May 20, 1954

**Shot no.:** GMX-2-284-26 through 284-30; GMX-8-B-3211

**Diameter:** 1 in.      **Average density:** 1.690 g/cm<sup>3</sup>

**Booster:** 1E15 detonator and 2.000-in.-long Comp B

<u>Increment no.</u>	<u>Length (in.)</u>	<u>Density (g/cm<sup>3</sup>)</u>	<u>Velocity (m/s)</u>
1	2.000	1.688	---
2	2.000	1.687	7305
3	2.000	1.694	7330
4	2.000	1.687	7334
5	2.000	1.694	7306

**Average velocity of increments 2-5:** 7319 m/s

**DETONATION VELOCITY DATA**

**Material:** 48.6 wt% TNT/36.4 wt% RDX/15.0 wt% ammonium perchlorate

**Experimenter:** J. B. Panowski      **Date:** May 20, 1954

**Shot no.:** GMX-2-284-6 through -284-10; GMX-8-B-3206

**Diameter:** 2 in.      **Average density:** 1.686 g/cm<sup>3</sup>

**Booster:** 1E15 detonator and 1.995-in.-long Comp B

<u>Increment no.</u>	<u>Length (in.)</u>	<u>Density (g/cm<sup>3</sup>)</u>	<u>Velocity (m/s)</u>
1	1.995	1.698	---
2	1.995	1.675	7363
3	1.995	1.671	7263
4	1.995	1.688	7362
5	1.995	1.698	7407

**Average velocity of increments 2-5:** 7349 m/s

## DETONATION VELOCITY DATA

**Material:** 48.6 wt% TNT/36.4 wt% RDX/15.0 wt% ammonium perchlorate

**Experimenter:** J. B. Panowski      **Date:** May 20, 1954

**Shot no.:** GMX-2-284-1 through -284-5; GMX-8-B-3185

**Diameter:** 2 in.      **Average density:** 1.690 g/cm<sup>3</sup>

**Booster:** 1E15 detonator and 1.995-in.-long Comp B

<u>Increment no.</u>	<u>Length (in.)</u>	<u>Density (g/cm<sup>3</sup>)</u>	<u>Velocity (m/s)</u>
1	1.995	1.697	---
2	1.996	1.687	7286
3	1.995	1.686	7395
4	1.995	1.690	7377
5	1.995	1.691	7369

**Average velocity of increments 2-5:** 7357 m/s



**DETONATION VELOCITY DATA**

**Material:** 48.6 wt% TNT/36.4 wt% RDX/15 wt% ammonium perchlorate

**Experimenter:** J. B. Panowski      **Date:** March 31, 1954

**Shot no.:** GMX-2-12-A; GMX-8-B-3116

**Diameter:** 1.625 in.      **Average density:** 1.713 g/cm<sup>3</sup>

**Booster:** 1E15 detonator and Comp B

<u>Increment no.</u>	<u>Length (in.)</u>	<u>Density (g/cm<sup>3</sup>)</u>	<u>Velocity (m/s)</u>
1	3.750	1.707	--
2	3.750	1.715	7429
3	3.750	1.719	7469
4	3.750	1.712	7459
5	3.500	1.710	7462
6	3.750	1.716	7457

**Average velocity of increments 2-6:** 7455 m/s

DETONATION VELOCITY DATA

**Material:** 40 wt% TNT/30 wt% RDX/30 wt% ammonium perchlorate

**Experimenter:** J. B. Panowski      **Date:** May 20, 1954

**Shot no.:** GMX-2-283-11 through -283-15; GMX-8-B-3192

**Diameter:** 0.666 in.      **Average density:** 1.715 g/cm<sup>3</sup>

**Booster:** 1E15 detonator and 2.000-in.-long Comp B

<u>Increment no.</u>	<u>Length (in.)</u>	<u>Density (g/cm<sup>3</sup>)</u>	<u>Velocity (m/s)</u>
1	2.000	1.716	---
2	2.000	1.715	7025
3	2.000	1.710	7024
4	2.000	1.710	7028
5	2.000	1.722	7031

**Average velocity of increments 2-5:** 7027 m/s

**DETONATION VELOCITY DATA**

**Material:** 40 wt% TNT/30 wt% RDX/30 wt% ammonium perchlorate

**Experimenter:** J. B. Panowski      **Date:** May 20, 1954

**Shot no.:** GMX-2-283-16 through -283-20; GMX-8-B-3213

**Diameter:** 0.666 in.      **Average density:** 1.716 g/cm<sup>3</sup>

**Booster:** 1E15 detonator and 2.000-in.-long Comp B

<u>Increment no.</u>	<u>Length (in.)</u>	<u>Density (g/cm<sup>3</sup>)</u>	<u>Velocity (m/s)</u>
1	2.000	1.712	---
2	2.000	1.710	---
3	2.000	1.722	7037
4	2.000	1.714	7020
5	2.000	1.720	7040

**Average velocity of increments 3-5:** 7032 m/s

## DETONATION VELOCITY DATA

**Material:** 40 wt% TNT/30 wt% RDX/30 wt% ammonium perchlorate

**Experimenter:** J. B. Panowski      **Date:** May 21, 1954

**Shot no.:** GMX-2-283-27 through -283-31; GMX-8-B-3210

**Diameter:** 1 in.      **Average density:** 1.717 g/cm<sup>3</sup>

**Booster:** 1E15 detonator and 2.000-in.-long Comp B

<u>Increment no.</u>	<u>Length (in.)</u>	<u>Density (g/cm<sup>3</sup>)</u>	<u>Velocity (m/s)</u>
1	2.000	1.714	---
2	2.000	1.721	7167
3	2.000	1.715	7093
4	2.000	1.717	7127
5	2.000	1.716	7129

**Average velocity of increments 2-5:** 7129 m/s

**DETONATION VELOCITY DATA**

**Material:** 40 wt% TNT/30 wt% RDX/30 wt% ammonium perchlorate

**Experimenter:** J. B. Panowski      **Date:** May 21, 1954

**Shot no.:** GMX-2-283-22 through -283-26; GMX-8-B-3188

**Diameter:** 1 in.      **Average density:** 1.718 g/cm<sup>3</sup>

**Booster:** 1E15 detonator and 2.000-in.-long Comp B

<u>Increment no.</u>	<u>Length (in.)</u>	<u>Density (g/cm<sup>3</sup>)</u>	<u>Velocity (m/s)</u>
1	2.000	1.718	---
2	2.000	1.724	7134
3	2.000	1.718	7136
4	2.000	1.716	7138
5	2.000	1.713	---

**Average velocity of increments 2-4:** 7136 m/s

DETONATION VELOCITY DATA

**Material:** 40 wt% TNT/30 wt% RDX/30 wt% ammonium perchlorate

**Experimenter:** J. B. Panowski    **Date:** May 20, 1954

**Shot no.:** GMX-2-283-1 through -283-5; GMX-8-B-3186

**Diameter:** 2 in.    **Average density:** 1.711 g/cm<sup>3</sup>

**Booster:** 1E15 detonator and 1.995-in.-long Comp B

<u>Increment no.</u>	<u>Length (in.)</u>	<u>Density (g/cm<sup>3</sup>)</u>	<u>Velocity (m/s)</u>
1	1.995	1.704	---
2	1.995	1.709	7280
3	1.995	1.711	7262
4	1.994	1.714	7283
5	1.995	1.718	7271

**Average velocity of increments 2-5:** 7274 m/s

DETONATION VELOCITY DATA

**Material:** 40 wt% TNT/30 wt% RDX/30 wt% ammonium perchlorate

**Experimenter:** J. B. Panowski      **Date:** May 20, 1954

**Shot no.:** GMX-2-283-6 through -283-10; GMX-8-B-3205

**Diameter:** 2 in.      **Average density:** 1.717 g/cm<sup>3</sup>

**Booster:** 1E15 detonator and 1.995-in.-long Comp B

<u>Increment no.</u>	<u>Length (in.)</u>	<u>Density (g/cm<sup>3</sup>)</u>	<u>Velocity (m/s)</u>
1	1.995	1.717	---
2	1.995	1.714	7257
3	1.995	1.717	7270
4	1.995	1.716	7268
5	1.995	1.719	7340

**Average velocity of increments 2-5:** 7284 m/s

DETONATION VELOCITY DATA

**Material:** 40 wt% TNT/30 wt% RDX/30% ammonium perchlorate

**Experimenter:** J. B. Panowski     **Date:** March 31, 1954

**Shot no.:** GMX-2-13-A; GMX-8-B-3117

**Diameter:** 1.625 in.     **Average density:** 1.732 g/cm<sup>3</sup>

**Booster:** 1E15 detonator and Comp B

<u>Increment no.</u>	<u>Length (in.)</u>	<u>Density (g/cm<sup>3</sup>)</u>	<u>Velocity (m/s)</u>
1	3.750	1.731	---
2	3.500	1.730	7291
3	3.500	1.733	7302
4	3.750	1.735	7302
5	3.750	1.733	7292
6	3.750	1.729	7294

**Average velocity of increments 2-6:** 7296 m/s



**DETONATION VELOCITY DATA**

**Material:** TNTAB

**Experimenter:** M. J. Urizar      **Date:** June 2, 1953

**Shot no.:** GMX-2-14161; GMX-8-B-2472

**Diameter:** 0.25 in.      **Average density:** 0.801 g/cm<sup>3</sup>      **Voids:** 55.95%

**Fabrication:** Hand-pressed

**Booster:** 1E15 detonator

<u>Increment no.</u>	<u>Length (in.)</u>	<u>Density (g/cm<sup>3</sup>)</u>	<u>Velocity (m/s)</u>
1	1.000	0.800	---
2	1.000	0.798	5037
3	1.000	0.801	5085
4	1.000	0.801	5107
5	1.000	0.801	5090
6	1.000	0.801	5146
7	0.250	0.804	---

**Average velocity of increments 2-6:** 5093 m/s

DETONATION VELOCITY DATA

Material: TNTAB

Experimenter: M. J. Urizar Date: July 22, 1953

Shot no.: GMX-2-13423; GMX-8-B-2608

Diameter: 0.25 in. Average density: 0.803 g/cm<sup>3</sup> Voids: 56%

Fabrication: Pressed into tubes Confinement: 1-in.-diam wall brass

Booster: 1E15 detonator

<u>Increment no.</u>	<u>Length (in.)</u>	<u>Density (g/cm<sup>3</sup>)</u>	<u>Velocity (m/s)</u>
1	1.0000	0.799	---
2	1.0000	0.802	5131
3	0.9997	0.806	5145
4	0.9998	0.803	5122
5	0.9998	0.802	5097
6	0.9997	0.802	5112
7	0.2500	0.802	---

Average velocity of increments 2-6: 5121 m/s

**DETONATION VELOCITY DATA**

**Material:** TNTAB

**Experimenter:** M. J. Urizar      **Date:** July 2, 1953

**Shot no.:** GMX-2-13405; GMX-8-B-2540

**Diameter:** 0.25 in.      **Average density:** 1.349 g/cm<sup>3</sup>      **Voids:** 25%

**Fabrication:** Pressed into tube      **Confinement:** 1-in.-o.d. brass

**Booster:** 1E15 detonator

<u>Increment no.</u>	<u>Length (in.)</u>	<u>Density (g/cm<sup>3</sup>)</u>	<u>Velocity (m/s)</u>
1	1.0000	1.349	---
2	0.9998	1.351	6923
3	1.0003	1.350	6930
4	0.9998	1.347	6927
5	0.9998	1.350	6963
6	1.0000	1.346	6920
7	0.2500	1.350	---

**Average velocity of increments 2-6:** 6933 m/s

DETONATION VELOCITY DATA

**Material:** TNTAB

**Experimenter:** M. J. Urizar      **Date:** June 30, 1953

**Shot no.:** GMX-2-13404; GMX-8-B-2539

**Diameter:** 0.25 in.      **Average density:** 1.354 g/cm<sup>3</sup>      **Voids:** ~ 25%

**Fabrication:** Pressed into tube

**Booster:** 1E15 detonator

<u>Increment no.</u>	<u>Length (in.)</u>	<u>Density (g/cm<sup>3</sup>)</u>	<u>Velocity (m/s)</u>
1	1.000	1.371	---
2	1.000	1.355	6960
3	1.000	1.355	6951
4	1.000	1.351	6919
5	1.000	1.354	6932
6	1.000	1.350	6972
7	0.2500	1.343	---

**Average velocity of increments 2-6:** 6947 m/s

DETONATION VELOCITY DATA

Material: TNTAB

Experimenter: M. J. Urizar Date: April 28, 1953

Shot no.: GMX-2-13370; GMX-8-B-2388

Diameter: 0.25 in. Average density: 1.347 g/cm<sup>3</sup> Voids: ~ 25.5%

Fabrication: Air press, 35 lb

Booster: 1E15 detonator

<u>Increment no.</u>	<u>Length (in.)</u>	<u>Density (g/cm<sup>3</sup>)</u>	<u>Velocity (m/s)</u>
1	1.0065	1.353	---
2	1.0092	1.347	7180
3	1.0074	1.348	7135
4	1.0068	1.348	7133
5	1.0064	1.348	7045
6	1.0089	1.348	7150
7	0.2512	1.335	---

Average velocity of increments 2-6: 7129 m/s

DETONATION VELOCITY DATA

Material: TNTAB

Experimenter: M. J. Urizar Date: July 13, 1953

Shot no.: GMX-2-13413; GMX-8-B-2579

Diameter: 0.2500 in. Average density: 1.494 g/cm<sup>3</sup> Voids: 17%

Fabrication: Pellets pressed into brass Confinement: 1-in.-o.d. brass

Booster: 1E15 detonator

<u>Increment no.</u>	<u>Length (in.)</u>	<u>Density (g/cm<sup>3</sup>)</u>	<u>Velocity (m/s)</u>
1	1.0057	1.494	---
2	1.0098	1.494	7574
3	1.0074	1.498	7559
4	1.0078	1.496	7511
5	1.0075	1.496	7582
6	1.0086	1.497	7572
7	0.2500	1.496	---

Average velocity of increments 2-6: 7560 m/s

DETONATION VELOCITY DATA

**Material:** TNTAB

**Experimenter:** M. J. Urizar      **Date:** February 3, 1956

**Shot no.:** GMX-2-882-A; GMX-8-B-3864

**Diameter:** 0.25 in.      **Average density:** 1.498 g/cm<sup>3</sup>      **Voids:** 17.2%

**Fabrication:** Pressed into tubes      **Confinement:** 0.375-in. wall brass

**Booster:** 1E15 detonator

<u>Increment no.</u>	<u>Length (in.)</u>	<u>Density (g/cm<sup>3</sup>)</u>	<u>Velocity (m/s)</u>
1	2.000	1.486	--
2	2.000	1.491	7403
3	2.000	1.505	7441
4	2.000	1.499	7436
5	2.000	1.502	7426
6	1.999	1.501	7423
7	2.000	1.500	7421
8	2.000	1.502	7404

**Average velocity of increments 2-8:** 7422 m/s

DETONATION VELOCITY DATA

Material: TNTAB

Experimenter: M. J. Urizar Date: July 7, 1953

Shot no.: GMX-2-13408; GMX-8-B-2570

Diameter: 0.25 in. Average density: 1.500 g/cm<sup>3</sup> Voids: 17.4%

Fabrication: Pressed into brass tubes Confinement: 1-in.-o.d. brass

Booster: 1E15 detonator

<u>Increment no.</u>	<u>Length (in.)</u>	<u>Density (g/cm<sup>3</sup>)</u>	<u>Velocity (m/s)</u>
1	1.0003	1.491	---
2	1.0003	1.500	7405
3	1.0003	1.501	7403
4	1.0000	1.499	7459
5	1.0002	1.498	7441
6	1.0002	1.498	7415
7	0.2500	1.510	---

Average velocity of increments 2-6: 7425 m/s



DETONATION VELOCITY DATA

**Material:** TNTAB

**Experimenter:** M. J. Urizar      **Date:** April 27, 1955

**Shot no.:** GMX-2-676; GMX-8-B-3614

**Diameter:** 0.25 in.      **Average density:** 1.500 g/cm<sup>3</sup>      **Voids:** 17.5%

**Fabrication:** Pressed into tubes      **Confinement:** 0.375-in. wall brass

**Booster:** 1E15 detonator

<u>Increment no.</u>	<u>Length (in.)</u>	<u>Density (g/cm<sup>3</sup>)</u>	<u>Velocity (m/s)</u>
1	1.9995	1.492	7453
2	2.0000	1.497	7474
3	2.0000	1.502	7519
4	2.0000	1.508	7549

**Average velocity of increments 1-4:** 7499 m/s

DETONATION VELOCITY DATA

**Material:** TNTAB

**Experimenter:** M. J. Urizar      **Date:** November 30, 1953

**Shot no.:** GMX-2-106; GMX-8-B-2910

**Diameter:** 0.25 in.      **Average density:** 1.495 g/cm<sup>3</sup>      **Voids:** 17%

**Fabrication:** Pressed in brass split mold      **Confinement:** 0.375-in. wall brass

**Booster:** 1E15 detonator

<u>Increment no.</u>	<u>Length (in.)</u>	<u>Density (g/cm<sup>3</sup>)</u>	<u>Velocity (m/s)</u>
1	1.9850	1.493	---
2	1.9842	1.496	7562
3	1.9793	1.495	7580
4	1.9793	1.495	7537
5	0.2480	1.495	---

**Average velocity of increments 2-4:** 7560 m/s

DETONATION VELOCITY DATA

**Material:** TNTAB

**Experimenter:** M. J. Urizar      **Date:** April 21, 1953

**Shot no.:** GMX-2-13361; GMX-8-B-2377

**Diameter:** 0.25 in.      **Average density:** 1.498 g/cm<sup>3</sup>      **Voids:** 17.2%

**Fabrication:** Air pressed

**Booster:** 1E15 detonator

<u>Increment no.</u>	<u>Length (in.)</u>	<u>Density (g/cm<sup>3</sup>)</u>	<u>Velocity (m/s)</u>
1	1.0113	1.497	---
2	1.0130	1.499	7614
3	1.0112	1.498	7529
4	1.0105	1.497	7589
5	1.0087	1.498	7560
6	1.0097	1.498	7630
7	0.2525	1.498	---

**Average velocity of increments 2-6:** 7584 m/s

DETONATION VELOCITY DATA

**Material:** TNTAB

**Experimenter:** M. J. Urizar      **Date:** February 28, 1956

**Shot no.:** GMX-2-882-B; GMX-8-B-3873

**Diameter:** 0.25 in.      **Average density:** 1.525 g/cm<sup>3</sup>      **Voids:** 14.7%

**Fabrication:** Pressed into tubes      **Confinement:** 0.375-in. wall brass

**Booster:** 1E15 detonator

<u>Increment no.</u>	<u>Length (in.)</u>	<u>Density (g/cm<sup>3</sup>)</u>	<u>Velocity (m/s)</u>
1	1.110	1.483	7544
2	2.000	1.545	7585
3	2.0000	1.546	7595

**Average velocity of increments 1-3:** 7575 m/s

DETONATION VELOCITY DATA

**Material:** TNTAB

**Experimenter:** M. J. Urizar      **Date:** October 20, 1953

**Shot no.:** GMX-2-75; GMX-8-B-2814

**Diameter:** 0.2500 in.      **Average density:** 1.550 g/cm<sup>3</sup>      **Voids:** 15%

**Confinement:** 1-in.-o.d. brass with 0.253-in. i.d.

**Booster:** 1E15 detonator

<u>Increment no.</u>	<u>Length (in.)</u>	<u>Density (g/cm<sup>3</sup>)</u>	<u>Velocity (m/s)</u>
1	2.0046	1.547	---
2	2.0010	1.550	7754
3	2.0000	1.550	7726
4	2.0000	1.550	7740
5	0.2502	1.548	---

**Average velocity of increments 2-4:** 7740 m/s

DETONATION VELOCITY DATA

**Material:** TNTAB

**Experimenter:** M J. Urizar      **Date:** April 21, 1953

**Shot no.:** GMX-2-13360; GMX-8-B-2376

**Diameter:** 0.25 in.      **Average density:** 1.641 g/cm<sup>3</sup>      **Voids:** ~ 9%

**Fabrication:** Air press, 37 lb/min      **Confinement:** 0.375-in. wall brass

**Booster:** 1E15 detonator

<u>Increment no.</u>	<u>Length (in.)</u>	<u>Density (g/cm<sup>3</sup>)</u>	<u>Velocity (m/s)</u>
1	1.0143	1.631	---
2	1.0127	1.639	8050
3	1.0149	1.645	8134
4	1.0144	1.646	8056
5	1.0146	1.648	7990
6	1.0148	1.649	8060
7	0.2537	1.631	---

**Average velocity of increments 2-6:** 8058 m/s

DETONATION VELOCITY DATA

**Material:** TNTAB

**Experimenter:** M. J. Urizar      **Date:** April 10, 1953

**Shot no.:** GMX-2-13359; GMX-8-B-2343

**Diameter:** 0.25 in.      **Average density:** 1.764 g/cm<sup>3</sup>      **Voids:** ~ 2%

**Fabrication:** Air press, cold

**Booster:** 1E15 detonator

<u>Increment no.</u>	<u>Length (in.)</u>	<u>Density (g/cm<sup>3</sup>)</u>	<u>Velocity (m/s)</u>
1	1.0234	1.761	---
2	1.0275	1.766	8256
3	1.0273	1.766	8252
4	1.0258	1.766	8263
5	1.0271	1.766	8316
6	1.0265	1.766	8282
7	0.2558	1.758	---

**Average velocity of increments 2-6:** 8274 m/s

## DETONATION VELOCITY DATA

**Material:** Tritonal, 80 wt% TNT/20 wt% aluminum

**Experimenter:** J. B. Panowski      **Date:** May 13, 1955

**Shot no.:** GMX-2-723-A; GMX-8-B-3627

**Diameter:** 0.750 in.      **Average density:** 1.409 g/cm<sup>3</sup>      **Voids:** 20.87%

**Booster:** 1E15 detonator and Comp B

<u>Increment no.</u>	<u>Length (in.)</u>	<u>Density (g/cm<sup>3</sup>)</u>	<u>Velocity (m/s)</u>
1	1.970	1.390	---
2	1.976	1.412	---
3	1.980	1.410	---
4	1.980	1.411	5397
5	1.980	1.413	5391
6	1.975	1.412	5376
7	1.978	1.410	5369
8	1.976	1.413	5401
9	1.975	1.413	5402

**Average velocity of increments 4-9:** 5389 m/s



**DETONATION VELOCITY DATA**

**Material:** Tritonal, 80 wt% TNT/20 wt% aluminum

**Experimenter:** J. B. Panowski      **Date:** May 13, 1955

**Shot no.:** GMX-2-723-B; GMX-8-B-3628

**Diameter:** 0.750 in.      **Average density:** 1.415 g/cm<sup>3</sup>      **Voids:** 20.58%

**Booster:** 1E15 detonator and Comp B

<u>Increment no.</u>	<u>Length (in.)</u>	<u>Density (g/cm<sup>3</sup>)</u>	<u>Velocity (m/s)</u>
1	1.976	1.399	---
2	1.979	1.415	---
3	1.977	1.416	5403
4	1.976	1.417	5400
5	1.978	1.415	5394
6	1.977	1.419	5429
7	1.978	1.417	5402
8	1.998	1.417	5424
9	1.980	1.416	5402

**Average velocity of increments 3-9:** 5408 m/s

DETONATION VELOCITY DATA

**Material:** Tritonal, 80 wt% TNT/20 wt% aluminum

**Experimenter:** J. B. Panowski     **Date:** May 6, 1955

**Shot no.:** GMX-2-699-C; GMX-8-B-3618

**Diameter:** 1 in.     **Average density:** 1.414 g/cm<sup>3</sup>     **Voids:** 20.70%

**Booster:** 1E15 detonator and Comp B

<u>Increment no.</u>	<u>Length (in.)</u>	<u>Density (g/cm<sup>3</sup>)</u>	<u>Velocity (m/s)</u>
1	3.969	1.410	---
2	1.980	1.419	5406
3	1.986	1.412	5415
4	1.988	1.417	5453
5	1.992	1.411	5402
6	1.991	1.414	5439
7	1.987	1.414	5442
8	1.976	1.417	5424
9	1.987	1.411	5408

**Average velocity of increments 2-9:** 5424 m/s

**DETONATION VELOCITY DATA**

**Material:** Tritonal, 80 wt% TNT/20 wt% aluminum

**Experimenter:** J. B. Panowski      **Date:** April 29, 1955

**Shot no.:** GMX-2-699-B; GMX-8-B-3616

**Diameter:** 1.625 in.      **Average density:** 1.424 g/cm<sup>3</sup>      **Voids:** 20.08%

**Booster:** 1E15 detonator and Comp B

<u>Increment no.</u>	<u>Length (in.)</u>	<u>Density (g/cm<sup>3</sup>)</u>	<u>Velocity (m/s)</u>
1	2.6680	1.411	---
2	1.7820	1.428	5515
3	1.7805	1.424	5467
4	1.7730	1.427	5530
5	1.7820	1.425	5468
6	1.7810	1.426	5486
7	1.7815	1.425	5476
8	1.7795	1.425	5487
9	1.7830	1.425	5484
10	1.7820	1.425	5426

**Average velocity of increments 2-10:** 5482 m/s

DETONATION VELOCITY DATA

**Material:** Tritonal, 80 wt% TNT/20 wt% aluminum

**Experimenter:** J. B. Panowski      **Date:** April 29, 1955

**Shot no.:** GMX-2-699-A; GMX-8-B-3615

**Diameter:** 1.625 in.      **Average density:** 1.420 g/cm<sup>3</sup>      **Voids:** 20.30%

**Booster:** 1E15 detonator and Comp B

<u>Increment no.</u>	<u>Length (in.)</u>	<u>Density (g/cm<sup>3</sup>)</u>	<u>Velocity (m/s)</u>
1	2.6650	1.412	---
2	1.7810	1.418	5456
3	1.7795	1.421	5464
4	1.7815	1.420	5466
5	1.7780	1.422	5457
6	1.7795	1.423	5496
7	1.7785	1.423	5651
8	1.7815	1.422	5602
9	1.7780	1.422	5487

**Average velocity of increments 2-9:** 5510 m/s

DETONATION VELOCITY DATA

**Material:** Tritonal, 80 wt% TNT/20 wt% aluminum

**Experimenter:** J. B. Panowski      **Date:** May 6, 1955

**Shot no.:** GMX-2-699-D; GMX-8-B-3619

**Diameter:** 1 in.      **Average density:** 1.425 g/cm<sup>3</sup>      **Voids:** 20.14%

**Booster:** 1E15 detonator and Comp B

<u>Increment no.</u>	<u>Length (in.)</u>	<u>Density (g/cm<sup>3</sup>)</u>	<u>Velocity (m/s)</u>
1	2.974	1.409	---
2	1.982	1.421	5430
3	1.984	1.424	5463
4	1.982	1.425	5473
5	1.981	1.426	5443
6	1.980	1.425	5501
7	1.987	1.423	5454
8	1.982	1.422	5443
9	1.979	1.424	5442
10	1.982	1.425	5445

**Average velocity of increments 2-10:** 5455 m/s

DETONATION VELOCITY DATA

**Material:** Tritonal, 80 wt% TNT/20 wt% aluminum

**Experimenter:** J. B. Panowski      **Date:** June 8, 1955

**Shot no.:** GMX-2-741; GMX-8-B-3642

**Diameter:** 3 in.      **Average density:** 1.442 g/cm<sup>3</sup>      **Voids:** 19.13%

**Booster:** 1E15 detonator and Comp B

<u>Increment no.</u>	<u>Length (in.)</u>	<u>Density (g/cm<sup>3</sup>)</u>	<u>Velocity (m/s)</u>
1	2.953	1.440	---
2	1.965	1.442	5463
3	1.968	1.441	5491
4	1.967	1.442	5508
5	1.968	1.441	5503
6	1.968	1.441	5516
7	1.967	1.440	5524
8	1.969	1.444	5534
9	1.968	1.441	5545
10	1.967	1.445	5576
11	1.969	1.441	5541
12	1.970	1.444	5561

**Average velocity of increments 2-12:** 5524 m/s



## GLOSSARY

ADNT	Ammonium 3,5-dinitro-1,2,4-triazolate
ANFO	Ammonium nitrate and fuel oil
Comp B-3	60 wt% RDX/40 wt% TNT
DATB	Diaminotrinitrobenzene
DBA-1	24 wt% TNT/41 wt% ammonium nitrate/16 wt% sodium nitrate/17 wt% water/2 wt% wax
Destex	74.8 wt% TNT/18.7 wt% aluminum/4.6 wt% wax/1.9 wt% graphite; also called X-0309
DNPA	Poly (2,2-dinitropropyl) acrylate
DNPM	Bis (2,2-dinitropropyl) maleate
DNT	Dinitrotoluene
DOP	Diocetyl phthalate
Exon	A polyvinyl resin
Kel-F	A chlorofluoroethylene polymer
HMX	Cyclotetramethylene tetranitramine
NC	Nitrocellulose
PBX 9010	90 wt% RDX/10 wt% Kel-F 3700
PBX 9205	92 wt% RDX/6 wt% PS/2 wt% DOP
PBX 9404	94 wt% HMX/3 wt% NC/3 wt% chloroethylphosphate
PBX 9407	94 wt% RDX/6 wt% Exon-461
PBX 9501	95 wt% HMX/2.5 wt% Estane 5703FI/2.5 wt% nitroplasticizer
PBX 9502	95 wt% TATB/5 wt% Kel-F 800
PETN	Pentaerythritol tetranitrate
PS	Polystyrene, a thermoplastic synthetic resin
RDX	Cyclotrimethylenetrinitramine
Saran E-242	A fiber composed of at least 80 wt% vinylidene chloride
Silastic 160	A plasticizer containing organo-silicon polymers
TATB	Triaminotrinitrobenzene
TNT	Trinitrotoluene
TNTAB	Trinitrotriazidobenzene
TOF	Triocetylphosphate, a plasticizer
X-0320	60 wt% TATB/35 wt% HMX/5 wt% Kel-F 800
X-0321	75 wt% TATB/20 wt% HMX/5 wt% Kel-F 800
X-0341	90.25 wt% TATB/4.75 wt% HMX/5.0 wt% Kel-F 800